

Manufacturers of Laboratory Glassware
and Laboratory Equipment

PROUDLY MADE IN 
india

BOROSIL®

enabling the future of science



PRICELIST 2021-22

Effective from 1st APRIL 2021

LABQUEST BY BOROSIL®

Manufacturers of Laboratory Equipment

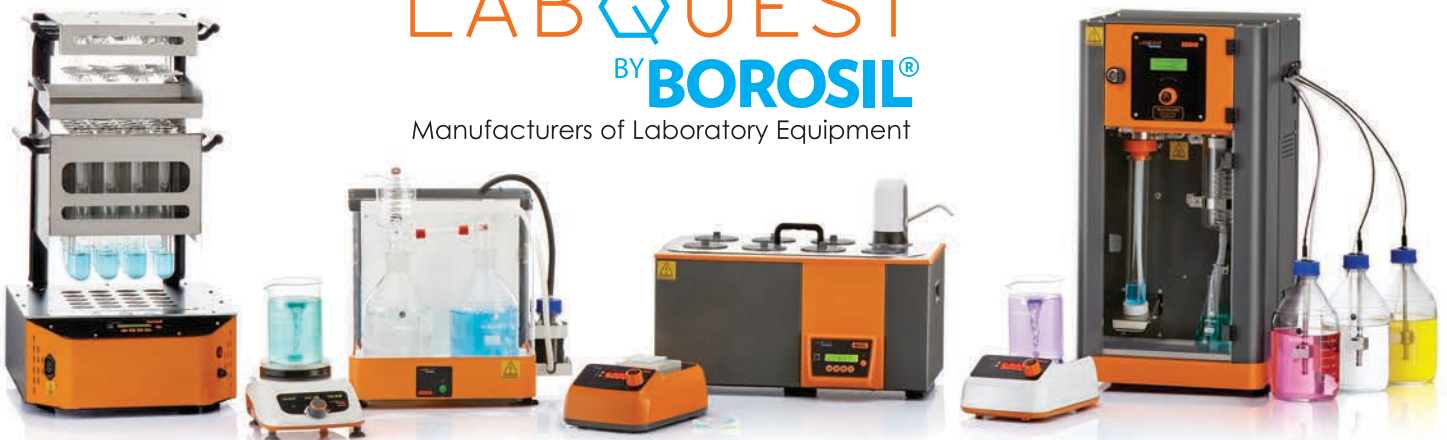

MISSION & VISION

Our mission is to emerge as a preferred vendor for laboratory glassware in the domestic as well as international markets. We would also develop a complimentary range of laboratory consumables in our product portfolio.

While in this wonderful journey we want to enhance our marketing capabilities, continuously improve our quality and services, invest in our people, yield profits for our stake holders and be socially responsible.

Message from the Managing Director's Desk

“Borosil is proud to be a part of the scientific community and proud to have played our part in helping our pharmaceutical customers keep their plants running. With an extremely resilient supply chain, we ensured that critical laboratory supplies to our customers remained unabated even during the deepest part of the lockdown. In addition, our LabQuest equipment has been used as a critical part of the process to manufacture the Covid vaccine. Finally, Borosil Klasspack vials are being used for packaging the vaccine - an accomplishment that we are all very proud of!

”



Dear Customer,

The unprecedented pandemic of Covid 19 forced us to change many behaviors last year. We hope that the increased emphasis on healthcare research will continue into the future in order to help prevent recurrences of such a worldwide catastrophe.

Throughout the crisis, the pharmaceutical industry in India led from the front, ensuring critical drugs were available to needy patients while vaccine researchers came up with solutions to the virus in record time. Borosil is proud to be a part of the scientific community and honored to have played our part in helping our pharmaceutical customers keep their plants running. With an extremely resilient supply chain, we ensured that critical laboratory supplies to our customers remained unabated even during the deepest part of the lockdown. In addition, our LabQuest equipment has been used as a critical part of the process to manufacture the Covid vaccine. Finally, Borosil Klasspack vials are being used for packaging the vaccine - an accomplishment that we are all very proud of!

In the coming fiscal, our thrust on LabQuest laboratory equipment continues. Our quest is to make smart, rugged and practical laboratory instruments accessible to all laboratories in India. The focus is to deliver international quality at reasonable prices and overnight service. In this context, we are proud to introduce:

- 1.. **Heating control mantles and Chillers** that help you conduct precise experiments of distilling, extraction or drying.
2. **On-Demand Distillation Units** that deliver specified volumes of distilled water thereby reducing lab utility costs.
3. **SS Water Baths** to meet a wide spectrum of applications.
4. **Stirrers** for the most basic stirring to very precise stirring used in vaccine production
5. **Touch Screen interface and auto lift** equipped Kjeldahl Digestion & Distillation systems.

In Glassware, we've made major investments at our factories for laser marking of LIMS compatible QR code on the glassware. We believe that the future is QR coded glassware which will transform your laboratory into a smart and digitalized lab. Additionally, we are now well-equipped to serve you with customized glassware – that exactly fit your needs, in the fastest possible time. This year in the pricelist we have grouped the glassware products based on their usage and applications. We are sure that this will make the product search more user friendly for our customers.

The pandemic was a great teacher. We have been able to digitize and remotely organize many functions. As a customer or partner we hope to further enhance your experience with our products, deliveries and application support.

Wishing you a successful & prosperous fiscal in FY21-22

Yours truly,
Shreevar Kheruka
Managing Director

BOROSIL[®]

Quality Policy

"We, at Borosil Limited, are committed to understanding our customers' needs and fulfilling the same on time every time.

By bringing the voice of our customers inside the organization, we strive to be our customers' #1 preferred brand.

We are committed to achieving the highest level of customers satisfaction through improvements in quality of our products & services.

We believe in continual improvements and innovation in our business and manufacturing processes. We strive to ensure that our team achieves the highest quality output in the most efficient manner possible.

This will be achieved by our total commitment to:

- Communication with our customers to understand their needs
- Continuously updating our technical competence, system and processes
- Enhancing the expertise of our people by periodic training & reviews.
- Preserving our corporate values"

This policy will be available to all interested parties where appropriate



Shreevar Kheruka
Managing Director

Date : 01.05.2018

WHY BOROSIL®

1 Laboratory glassware

- Three out of four glassware articles used in laboratories across India are of Borosil
- Over 5 decades of trust

Certifications

- Certified for ISO 9001:2015 quality management system for Scientific Laboratory Glassware & Laboratory Equipment / Instrument
- NABL ISO/IEC :17025, 2017) accredited laboratory
- Represents India on ISO/TC 48 – Technical committee for laboratory glassware and apparatus

Quality and Compliance

- Advanced computed controlled machines for calibration
- Laser sensing of meniscus and real-time image of meniscus provided on calibration certificate
- Compliance to international standards ISO/DIN/ASTM for dimensions and tolerances

Infrastructure

- State-of-the-art blowing facility having 700+ skilled blowers
- Equipped with automated blank manufacturing machines
- Annealing process by unique Lehr technology
- Advanced laser machines for laser marking of LIMS compatible QR code and UID code

Unmatched Service Levels

- Network of 150 Channel Partners PAN India
- 5 warehouses across the country
- 96% of the time same day delivery
- Team of 65+ sales ambassadors PAN India
- Customer-centric approach

Corporate Profile

The BOROSIL Group comprises of

- Borosil Limited
- Borosil Renewables Limited
- Klass Pack Ltd.

Borosil Limited was established in December 1962 in collaboration with Corning Glass Works, USA, to manufacture borosilicate low expansion glass. In December 1988, Corning divested its shareholding to the current Indian promoters, who have been leading manufacturers of sheet glass in India, since 1961.

BOROSIL is the market leader in laboratory glassware and microwavable kitchenware in India.

Science and Industrial Products Division

Borosil's SIP division offers an entire gamut of the finest quality scientific and laboratory equipment through a pan India network of 150 dealers. This includes laboratory glassware, instruments, disposable plastics, liquid handling systems and explosion-proof lighting glassware. This range of over 2000 products finds application in across diverse disciplines such as Quality Control in pharmaceutical industries, food and soil testing, Microbiology, Biotechnology, Photo Printing, Process Systems and Lighting. Symbolising quality, accuracy and dependability since 6 Decades, Borosil has earned the trust and unwavering loyalty of leading pharmaceutical companies and R&D laboratories, as well as scientific, health and educational institutions.





Consumer Products Division

Borosil is India's most trusted glassware brand since 1962. Synonymous with heat-proof glassware, it is the market leader for consumer glassware in India.

Borosil's Consumer products aim at providing solutions for daily cooking, serving and storage needs of the consumer. In recent times, Borosil has expanded its consumer offering from its core glassware range to Opalware dinner sets (sold under the brand Larah), kitchen appliances, storage products, glass lunch boxes and stainless steel vacuum insulated flasks & bottles.

To cater to changing lifestyle needs and aspirations, Borosil has introduced a range of smart, practical and elegant Small Appliances, backed with Borosil's guarantee. These include Juicer Mixer Grinders, Hand Mixers, Oven Toaster Grillers, Toasters, Blenders and Rice Cookers. Moreover, to ensure that the user is never inconvenienced, each appliance is backed by our nation-wide customer service network.

Furthermore, Larah Opal glass products are a beautiful blend of elegance and performance, and are synonymous with Borosil's quest for perfection and excellence for over 50 years. Borosil has lent its expertise in glassware to this category making the products stronger and chip resistant. Contemporary designs, a range of sizes and colors coupled with the durability and toughness of the Opal glass result in this immaculately designed product with impeccable finish, to give the perfect dining experience.

For us, nothing is more important than the trust people place in us every time they welcome a Borosil product into their homes. Which is why, we don't just build products with utmost care but build them to make every day better. We do our best to ensure that our products always perform beautifully.

Visit www.myborosil.com for more details on products

Borosil Renewables Limited

Borosil Renewables Limited is the first and only solar glass manufacturer in India. The company spotted the opportunity in this segment quite early and commissioned the solar glass manufacturing facility at Bharuch in Indian State of Gujarat in January 2010. Over the last 5 years, the solar PV installations and module production across the world have grown exponentially. In order to cater to the growing demand, Borosil Renewables has recently expanded and more than doubled its existing production capacity of high performance solar glass to 2.4 GW per annum.

Borosil is the World's first and only producer of truly green, environment friendly, toxin free textured solar glass which is the most technically advanced glass in the world, with unique features of long term performance durability, high hydrolytic resistance, lowest sodium content & outstanding durability of AR coating

The company has a strong focus on innovation and known for its pioneering achievements like development of World's First fully tempered 2 mm thick solar glass, solar glass with lowest iron content giving highest glass efficiency, first company in the World to successfully be able to remove the most hazardous substance – "Antimony" - from its solar glass etc. Very recently the company has launched new products like Selene: an Anti-glare solar glass suitable for PV installations near airports, Shakti: a very high efficiency solar glass in matt-matt finish. Amongst the upcoming products with enhanced features is the solar glass with Anti-soiling coating.

The company has a strong focus on expanding its domestic & exports footprints. The exports business has grown at a CAGR of 33% in the last 3 financial years. European market is major customer base for the company where it has now successfully started supplies of its newly developed products, i.e. 2.0 mm and 2.5 mm fully tempered glass. With additional production now available, it has plans to substantially increase exports by tapping more customers in Europe as also increasing presence in the Americas.

Manufacturing facility is accredited with ISO 9001:2015, ISO 14001:2015 and BS OHSAS 18001:2007 certifications from TUV Rheinland. In-house laboratory is fully equipped with the latest and most advanced testing equipment to ensure top quality end product to the customer

Borosil Renewables Limited is a part of well-known Borosil group who are pioneers in speciality glass products.

#WeAreBOROSIL

On a mission to be India's most customer centric company

www.borosil.com



BOROSIL **KLASSPACK**[®]

pharmaceutical packaging

Klass Pack Ltd., now a subsidiary of Borosil Limited, is one of India's leading manufacturers of Glass Ampoules and Tubular Glass Vials of USP Type 1 that is widely used as primary packaging materials by pharmaceutical companies for their life-saving drugs. The factory is located at Nasik, around 180 kms from Mumbai.

Klass Pack Ltd. was established in 1994 and quickly became a leader in the Pharmaceutical Packaging segment. Borosil acquired Klasspack in 2016 and combined its technological expertise in specialty glass production with Klasspack's experience in world class glass ampoule and tubular glass vial manufacturing to establish its leadership in the fast-growing Pharmaceutical Packaging segment.

Klasspack an ISO 15378 certified company has registered products under the US DMF governed by US FDA for both Glass Ampoules and Tubular Glass Vials, and Canadian DMF (Neutral Glass Tubular Vials and Neutral Glass Ampoules). It has a state-of-the-art technology with installed capacity of over 200 million Glass Ampoules and over 165 million Glass Vials annually.

Klasspack is focused on a knowledge-based approach towards product development, and has pioneered various studies in India on its glass containers such as extraction studies. A dedicated team handles product development and regulatory documentation, and can render technical support in glass ranging from laboratory-scale to commercial production scale.

Klasspack is staffed with one of the most dynamic and qualified teams in the industry. It has won over customers with its flexible approach towards product customization and packaging, and a customer centric approach. It has built a solid reputation for quality and transparency, and meeting delivery commitments consistently without fail.

With a presence in more than 15 countries that includes the U.S., Netherlands, Switzerland, Guatemala, Saudi Arabia, Greece, Israel, Romania, Malaysia, Indonesia, Bangladesh and Thailand, Klasspack intends to further enhance its market-leading position in India and across the world, and offer pharma majors a reliable partner to source their primary glass packaging.

Klass Pack Ltd.

(A subsidiary of Borosil Limited)
info.klasspack@borosil.com
www.klasspack.com

Registered Office

H-27, MIDC, Ambad, Nashik 422010, India
T: +91 253 2382 404 / F : + 91 253 2387 907

Mumbai Office :

Borosil Limited
1101, Crescenzo, G-Block, Opp. MCA Club,
BKC, Bandra (E), Mumbai - 400 051, India
T : +91 22 6740 6300 / F : +91 22 6740 6514



BOROSIL®

TECHNOLOGIES

Borosil Technologies Limited is located at Hinjewadi, Pune and is a 100% owned subsidiary of Borosil Limited. Borosil Technologies Limited is mandated to develop Laboratory equipment which is offered by Borosil Limited branded as Labquest.

Borosil Technologies Limited is equipped with Industrial design, Mechanical design, Embedded, Electronic, Software design capabilities, modern Assembly lines, Prototyping facilities, Service Center and an Application Lab.

Products developed and produced by Borosil Technologies Limited include Water Baths, Dry Baths, Nitrogen Estimation Systems, Stirrers, Vortex Mixers, Glass care equipment.

All products are designed to be **SMART, RUGGED & PRACTICAL**



Borosil Technologies Ltd.

21-24, Plot no 8, India land Global Industrial Park,
Hinjewadi Phase - 1, Pune - 411057, India.

LAB  QUEST
BY **BOROSIL®**

ISO Certification

Certified for ISO 9001:2015 quality management system to ensure that our products are reliable, safe, consistent, meet customer expectations, continuously improve and comply with the law



ISO/TC 48



We take the pride to mention that **BOROSIL** represents India on **ISO/TC 48 - Technical Committee for Laboratory equipment and apparatus.**

**NEW
VERSION
IS LIVE**

Update the BOROSIL app now!

TWO EASY OPTIONS TO DOWNLOAD THE CERTIFICATE

SCAN
QR CODE



ENTER
UID CODE

Individual calibration certificate

BOROSIL®
Borosil Limited
(The wholly owned subsidiary of Borosil Glass Works Ltd and
Borosil India as defined elsewhere.)
CIN : US6100MH2010PLC292722
Corporate & Registered Office
100, Concorde, G-Bldg, Opp. MCA Club, Bandra Kurla Complex,
Bandra (E), Mumbai - 400 051, Maharashtra, India
Tel : +91 22 6740 6300 **Email** : lab.customercare@borosil.com
Fax : +91 22 6740 6314 **Website** : www.borosil.com

**Class "A"
TEST CERTIFICATE**

Certificate No. : 2020-02-M3-17454 **Date** : 20-Feb-2020
Test Method : Gravimetric Method based on ASTM E542
Item Tested : VOLUMETRIC FLASK-100 ml
Catalogue No. : 5645 **USP** DC 118 151Z 100.00 ml
Code No. : DC 118 151Z
Item Tested On : 20-Feb-2020
Nominal Volume : 100.00 ml
Tolerance : ± 0.08 ml **20-Feb-2020 16:40**

The Product was found to contain the following volume at 20 °C.
Certified Volume : 100.00 ml
Delivery Time : N/A

This Product has been calibrated with following devices:
Balance : Make :Sartorius, S.N.:25405822, Range:0-1000 g, LC:0.001 g
Thermometer : Make :Greisinger, S.N.:TS PR 10, Range:15-35 °C, LC:0.1 °C
All the above devices have valid calibration traceable to NPL (National Metrology Institute), India; traceable to CIPM France.
The above product has been examined for compliance to ASTM E288, Class A.
It has been found to satisfy the specified requirements.The above item has been calibrated at 23.3 °C at RH 44.0 %.
The above calibration result is valid at the time of calibration under lab condition.
This report shall not be reproduced, except in full,unless with written permission from **M/s Borosil Limited.**

Calibrated by : SYP
Date of issue : 29-Feb-2020

Authorised Signatory

Whole Time Director
Borosil Limited

Individual Calibration Certificate can also be accessed
on www.borosil.com

Factory and Production

Automatic Blank Manufacturing Facility

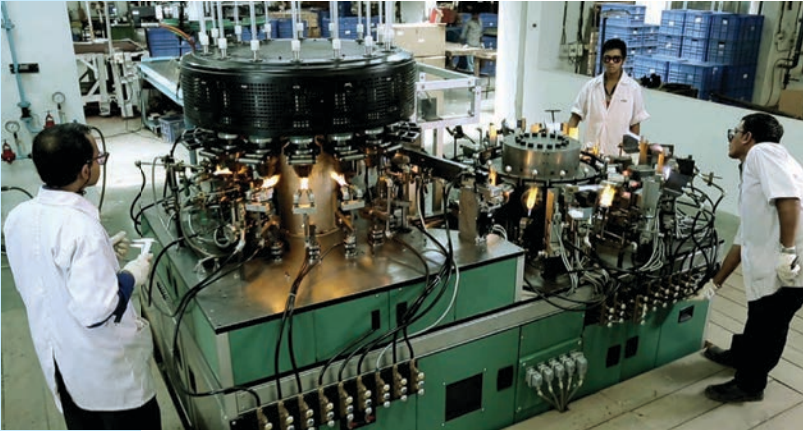

- State-of-art auto blowing facility used to produce blanks with uniform wall thickness and ensure exact shape and dimension according to the standards.
- All the blanks are manufactured from 3.3 Low Expansion Borosilicate Glass with controlled Internal Diameter tubing.

Unique Annealing Facility



- All **Borosil** glasswares pass through annealing Lehr chamber where the stresses are eliminated under controlled heating and cooling process
- This annealing process ensures the long lasting printing quality. In order to get highest level of precision, carefully controlled gradual heating and cooling procedures are essential

Petri Dish Manufacturing Facility



Manufacturing Facility at Tarapur



Advanced Printing Technology



- High definition printing for accurate and easy reading

Wall Thickness Measure



Automated Vial Forming Machine



"A local Global" with exports to 55 Countries

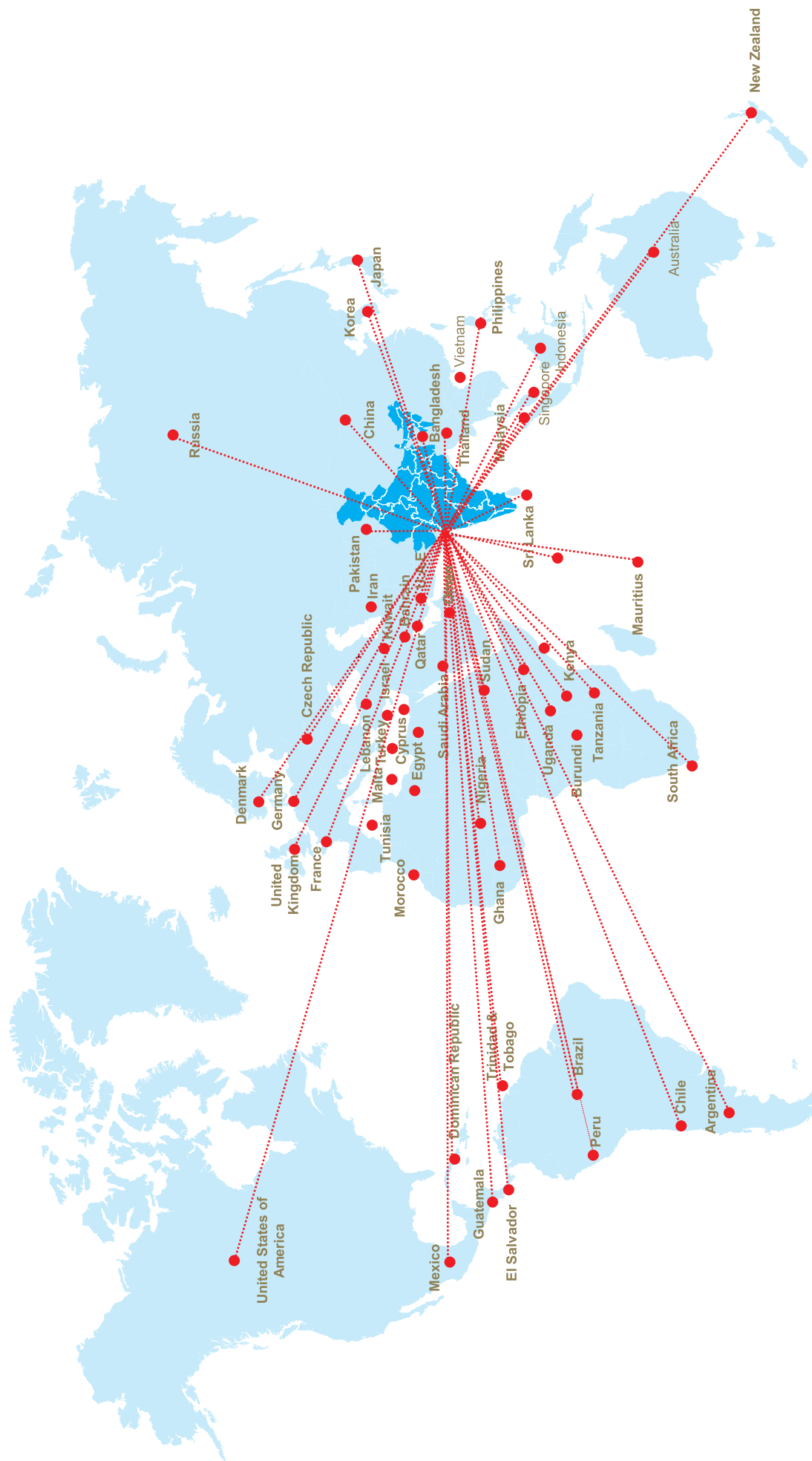

"Industry leading distribution network"

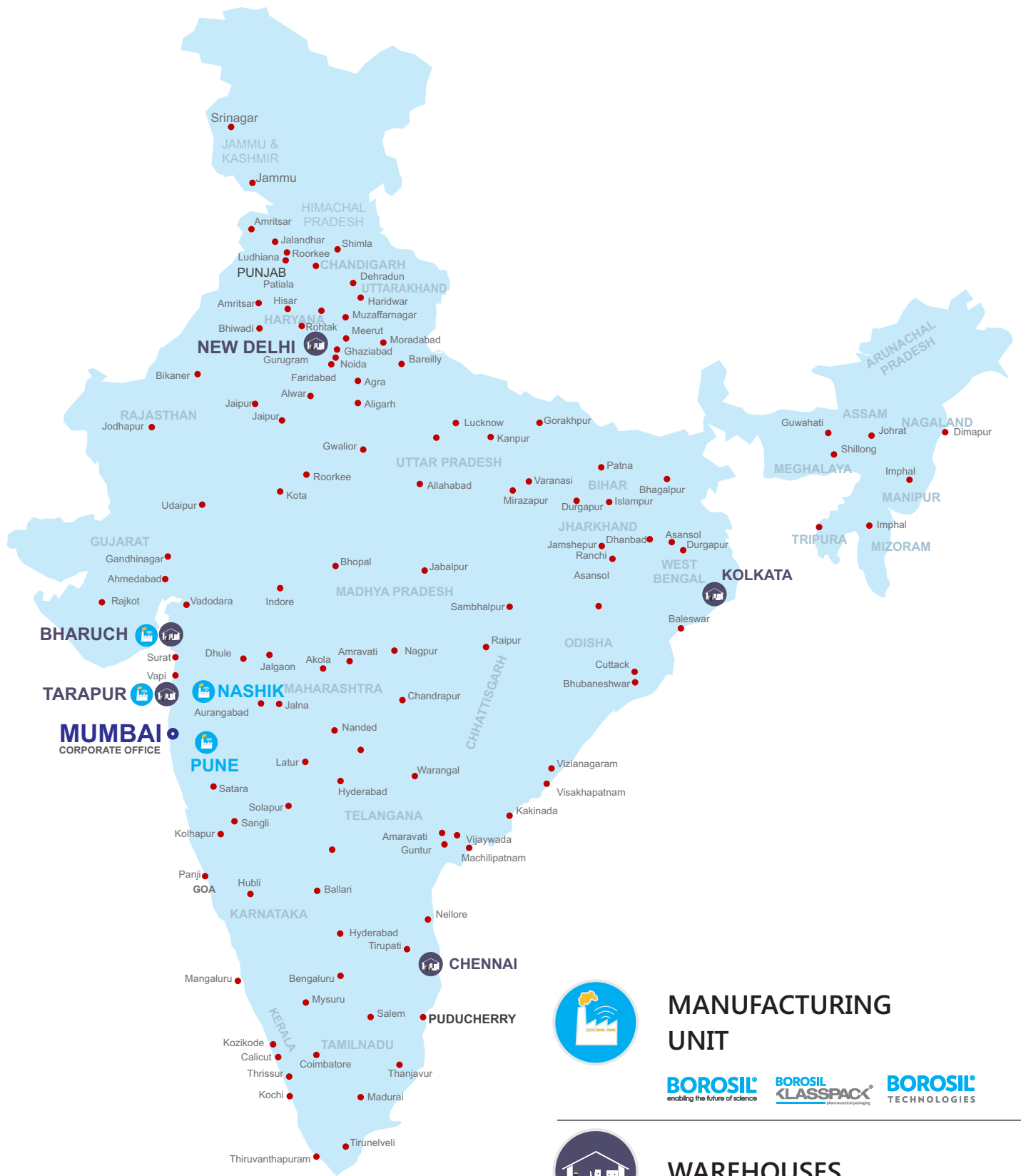

MANUFACTURING UNIT

BOROSIL
enabling the future of science

BOROSIL CLASSPACK
Personalized packaging

BOROSIL TECHNOLOGIES



WAREHOUSES

- TARAPUR • BHARUCH • DELHI
- CHENNAI • KOLKATA



PAN INDIA NETWORK OF 150 CHANNEL PARTNERS

Calibration Process



BOROSIL is India's single largest manufacturer of a complete range of Volumetric Glassware. Borosil's Volumetric products are used in all laboratories from high-end pharmaceutical production companies to high schools and colleges.

BOROSIL adheres to the highest quality standards, right from the raw material used to the measurement and calibration of the finished product. Visual and physical quality checks are undertaken at each stage of production, in order to ensure the highest quality product for customers.

BOROSIL ensures that every Volumetric Glassware product is of the highest quality in the following parameters:



ACCURACY

- Computer Controlled Calibration
- Reliability in experiments through individually certified volumetric glassware
- Facilitates audit procedures in the laboratory
- Enhanced production from new facility



MECHANICAL STRENGTH

- Optimum wall thickness
- Annealed glassware imparts better mechanical strength
- Ideal for vacuum application, wet and dry sterilization
- Harder, hence lasts longer



THERMAL SHOCK RESISTANCE

- Safely withstands thermal shock
- Annealed to remove residual thermal Stress
- Thinner, uniform wall, hence lasts longer



CHEMICAL DURABILITY

- High resistance to attack from acids, salt solutions and organic solvents
- Low alkalinity, hence less leaching
- Low alkalinity makes glass harder, hence lasts longer



Computer controlled automatic calibration machine with optical laser beams to prevent human error and ensure highest level of accuracy and precision

BOROSIL performs the calibration process with fully automatic state-of-the-art calibration machines that eliminate any possibility of human error. This also ensures a high degree of repeatable measurements for all Borosil Volumetric products.

BOROSIL has an in-house set-up of a well-equipped temperature-controlled calibration laboratory with precision electronic balances, thermometers and stopwatches that are traceable to national standards. Calibration of Volumetric Glassware is entrusted to only trained and experienced technicians.

The following steps are carried out by highly precise, fully automated computer-controlled machines:

1. Filling the Volumetric blanks with a precisely-defined amount of de-mineralized water under controlled temperature.
2. The meniscus is determined with a laser-controlled camera at the exact lowest point of the water level, and the calibration mark is made with a fine diamond wheel. This gives accuracies that cannot be achieved by manual calibration.
3. Cylinders, Burettes and Pipettes are marked at a minimum of two calibration points.
4. The wet surface area factor is always taken into account, throughout the process.
5. The calibration laboratory is temperature, light controlled and temperature is maintained at $23^{\circ}\text{C} \pm 2^{\circ}\text{C}$.

All Volumetric Glassware is calibrated either as **To contain TC / In**

The contained quantity of liquid corresponds exactly to the capacity indicated on the article (e.g. graduated cylinders and volumetric flasks).

To deliver TD / Ex

The delivered quantity of liquid corresponds exactly to the capacity indicated on the article. (e.g. pipette and burettes).

These steps ensure that each and every Volumetric product leaving the **BOROSIL** facility meets the highest international standards and can be used for various purposes with the highest degree of repeatability and accuracy.





Ecologically Responsible

Rain water harvesting has been deployed in our 110 acre facility in Gujarat, since 2003.

Wind energy is the source of 48% of all the electricity that we consume.

Our Borosolar water heating systems are used to heat the water supplied in all Borosil Guesthouses and Colonies..

Our other energy efficient measures include advanced waste heat recovery systems and solar lighting.

Our in-house 9 hole par 36 Golf Course is maintained by using the water from our rain water harvesting initiative.

WE nurture

Borosil supports and runs a school, for children from neighbouring villages and employees' children.

Borosil proposes to open a hospital in the near future.



WE care

Borosil supports GLOBAL PARLI - A Mission to Transform India Through Rural Economic Transformation



4.1 Mn+
Fruit Trees Planted Till February 2021



BOROSIL® SCORES A BRACE!

Two manufacturing sites
Borosil Limited, Bharuch, Gujarat & Borosil Klasspack, Nashik, Maharashtra
 won medals at the
Indian Green Manufacturing Challenge FY19-20

INDIA GREEN MANUFACTURING CHALLENGE 2019
 International Research Institute for Manufacturing™, India
SILVER MEDAL
 Presented to
BOROSIL LTD.
 (BHARUCH)

SILVER MEDAL WINNER
BOROSIL
 BHARUCH

INDIA GREEN MANUFACTURING CHALLENGE 2019
 International Research Institute for Manufacturing™, India
BRONZE MEDAL
 Presented to
BOROSIL CLASS PACK LTD.
 (KALSHIPAK, NASHIK)

BOROSIL | BHARUCH
 Borosil Limited

A testimony of the commitment of our teams
 to a sustainable tomorrow.

NASHIK | **BOROSIL CLASSPACK**
 Class Pack Ltd.

#Be Vocal about Local

Won medals at the Green Manufacturing Challenge FY 2019 -20

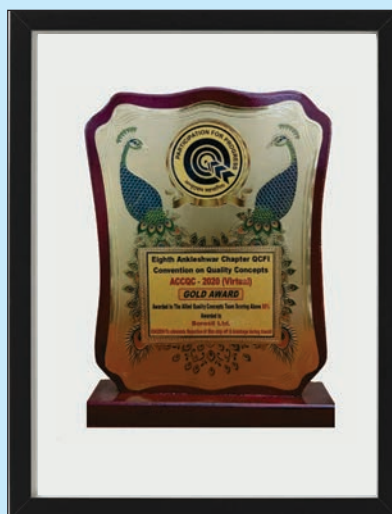

Won Gold Award for in QCFI Kaizen competition conducted by Quality Circle Forum of India – Anklshwar chapter



Won Silver Medal in National Awards for Manufacturing Competitiveness 2019 - 2020



Participated in the CII Nation Kaizen Competition Organized by CII TPM Club India

BOROSIL[®]

..... HYDRA

**SIPPING HOT WATER THROUGH THE DAY
CAN KEEP THE INFECTIONS AWAY.**



- SS 304 Stainless Steel Inside & Outside
- Copper Coating for Better Insulation
- Leak Proof Lid
- Easy to Pour & Drink
- Place it on your bedside, in the office or carry it wherever you go.
- Choose from a range of many designs.
- Also available in vibrant color options with different capacities.



**WHATSAPP @
+91 7208487334**

E-mail : myborosil@borosil.com / customercare@borosil.com | Toll Free No.: 1800 120 8499 / 1800 224 550

Now shop online for India's most trusted brand at www.myborosil.com

Follow us on     Borosil And You

BOROSIL®

NEW INTRODUCTIONS



- Volumetric Flasks with QR Code / UID Number..... 22-35
- Automatic Single Glass Distillation Unit & Double Distillation Unit..... 118 - 119
- Mortar And Pestle 170
- **BOROPURE** Glass Filtration Assembly 47mm with Bottle..... 195
- **BOROPURE** Membrane (3 Types) 232
- Classical Kjeldahl Distillation Unit 232

TO KNOW MORE CONTACT

our Sales Representative or write to us lab.customercare@borosil.com

Foreword

Borosil Limited presents to you, this Borosil Scientific and Laboratory Glassware Pricelist. Unless specific arrangements have been made to the contrary, the prices contained in this Pricelist are applicable to all goods despatched on or after **April 01, 2021**.

This Pricelist supersedes all previous prices. All prices stated herein are the recommended maximum price per piece in INR, and are exclusive of All Taxes, Goods and Services Tax (GST), any delivery charges, other statutory and non-statutory levies. The dealers are at liberty to charge prices lower than those stipulated herein.

Customised Glassware

We undertake the manufacture of special glassware to agreed specifications. Please send us your queries at the address below, including complete details of specifications, and drawings wherever possible. We would be pleased to assist you in formulating specifications within normal working tolerances. Usually, we only accept orders with a minimum ex-works value of INR 10,000/-.

Corporate Office :

Borosil Limited

Crescenzo, G-Block, Opp. MCA Club,

Bandra Kurla Complex,

Bandra (E), Mumbai - 400 051, India

Tel : 022 - 6740 6300

Fax : 022 - 6740 6514

Email : lab.customercare@borosil.com

Conditions of Sale

At Borosil, it is our policy to market our laboratory glassware through our wide network of Authorised Dealers. Strategically located all over India, they are best equipped to satisfy the individual requirements of users across the nation. The products supplied will usually be in accordance with illustrations and descriptions however, **Borosil reserves the right to make alterations and modifications depending upon circumstances and/or changes in official specifications, or as a result of design improvements.**

Although the products are guaranteed for glass quality and workmanship, Borosil shall not be liable for any loss or damage or injury, arising directly or indirectly from the use of these products.

The images given in the Pricelist are for reference purpose only.
Actual products may differ from the images.

CONTENTS

PG NO.

Volumetric Glassware

Volumetric Flasks / Stoppers / Pipettes / Cylinders / Burettes / NABL Certified Glassware / Pharmacopoeial Apparatus / Certified Working Standard Storage Vials / Dissolution Flasks

22-81

01

Volumetric
Glassware

Laboratory Bottles, Caps & Accessories

Aspirator Bottles / BOD bottles / Reagent Bottles / Caps and Pouring Rings / Solution Bottles / Relative Density Bottles / Specific Gravity Bottles / Weighing Bottles / Dropping Bottles / Wash Bottles / Gas Washing Bottles / Gas Sampling Tubes / Impinger / Plastic Clamp For Joint Fittings

82-97

02

Laboratory Bottles,
Caps & Accessories

General Laboratory Glassware

Beakers / Cones / Condensers / Chromatography Columns / Desiccators / Dishes / Distilling Apparatus / Water Distillation Units / Extractors / Flasks / Funnels / Glass Parts & Accessories (Cone / Socket / Adapters / Stoppers / Stirrer Rod / Watch Glass / Weighing Glass) Mortar & Pestle / Museum Jar / Test Tube / Tubes / Mansingh Survismeter / Viscometer

98-179

03

General Laboratory
Glassware

Glassware for Microbiology & Cell Culture

Roux Bottles / Haffkine Culture Flask / Petri Dishes / Spreader / Culture Tubes / Sampling & Storage Vials / Erlenmeyer Culture Flasks / Microscope Slide / Cover Glass

180-189

04

General for
Microbiology &
Cell Culture

Filtration Products

Glass Filtration Assembly / Filter Membranes

190-199

05

Filtration
Products

Laboratory Accessories

Tongs / Clamps / Clamps With Bosshead / Burette Clamps / Plastic Clamp For Joints / Retort Rings / Retort Base / Rod For Retort Base / Test Tube Stand / Test Tube Holder / Burner / Spatulas / Forceps / Wire Gauge / Tripod

200-207

06

Laboratory
Accessories

Quartz Ware & Sintered Ware

Beaker / Muffle Trays / Round Dishes / Combustion Boats / Crucibles / Silica Triangle / Erlenmeyer Flasks / Volumetric Flasks / Circular Capsule / Reagent Bottle / Measuring Cylinder / Filter Funnel / Mohr Pipette / Volumetric Pipette / Buchner Funnel / Gooch Crucible / Tube for Gooch Crucible

208-217

07

Quartzware &
Sintered Ware

Analytical Vials & Closures

Sample Vials & Closures / Headspace Vials & Closures / Pre-Assembled EPA-TOC

218-223

08

Analytical Vials &
Closures

Laboratory Equipment by LABQUEST

Nutrition and Environment / Water Distillation Unit / Heat & Stir / Vortex Mixers / Centrifuge & Shakers / Chiller / Liquid Handling Products

224-281

09

Laboratory
Equipment

BOROSIL[®]

Volumetric Glassware

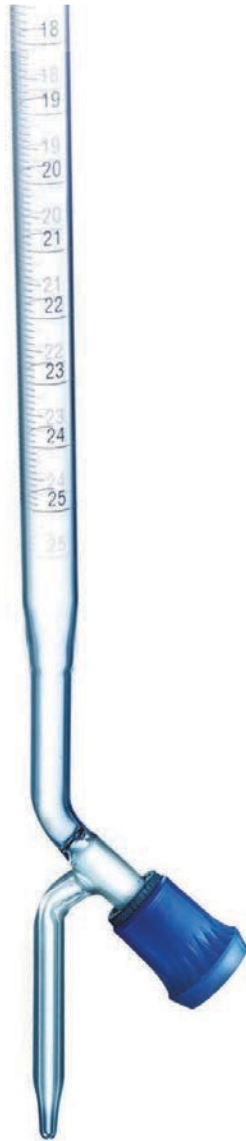

- VOLUMETRIC FLASKS
- STOPPERS
- PIPETTES
- CYLINDERS
- BURETTES
- NABL CERTIFIED GLASSWARE
- PHARMACOPOEIAL PRODUCTS
- CERTIFIED WORKING STANDARD STORAGE VIALS
- DISSOLUTION FLASK

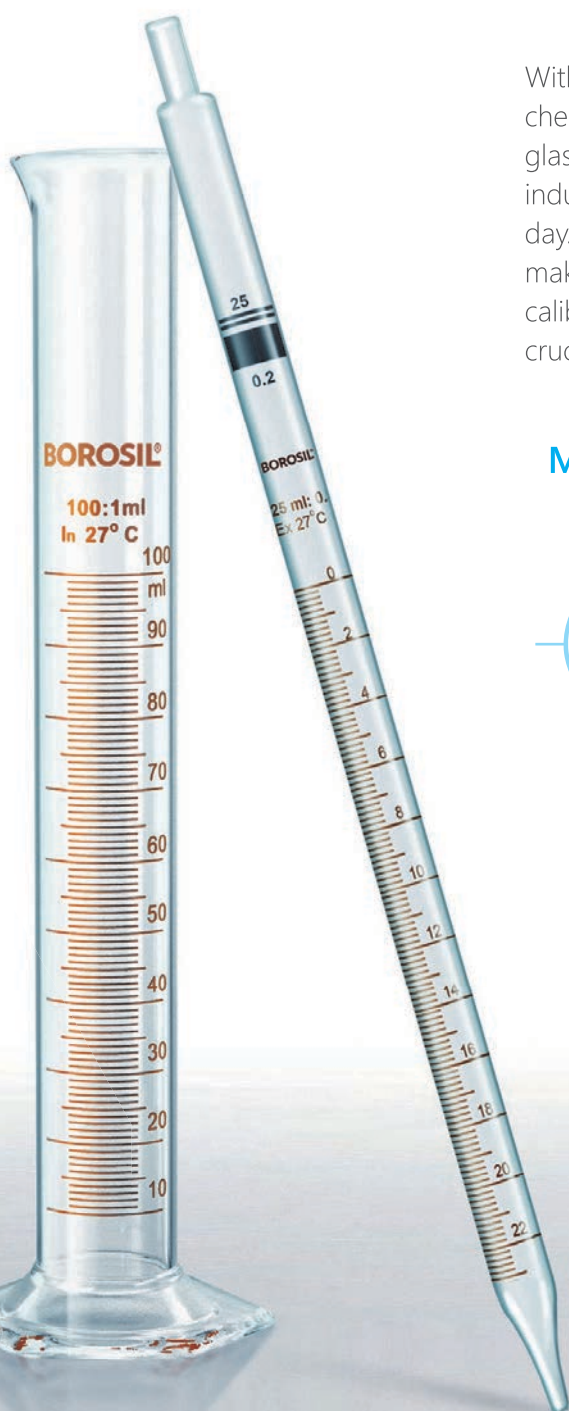

With continuous evolvement in the field of chemistry, the importance for high quality glassware in research, educational as well as industrial applications, is increasing day after day. Be it preparation of standard solutions or making the right volumes with appropriate calibration, volumetric glassware forms a crucial part of any chemical laboratory.

Made from 3.3 Low Expansion Borosilicate Glass



Volumetric Flask

Volumetric Flask is a laboratory glassware that is designed to hold a certain volume at a particular temperature and indicates the nominal volume, tolerance, precision class, relevant manufacturing standard etc. **BOROSIL** Volumetric Flasks are manufactured in a range of sizes that is capable of containing 1ml to 5,000 ml of liquid.

It is very important to understand that for analysis which demands high precision, the selection of instruments is very vital. In cases where precision analysis is expected, only high accuracy instruments give the desired results. Most sophisticated automatic instruments can deliver high precision results, only if the volumetric ware used to prepare samples is accurate.

- Individually calibrated with automatic calibration process
- Strict quality control through all steps eliminate possible deviations from nominal volume
- Supplied with individual certificate which can be downloaded from our website
- Volumetric Flasks are supplied with plastic or solid glass stopper



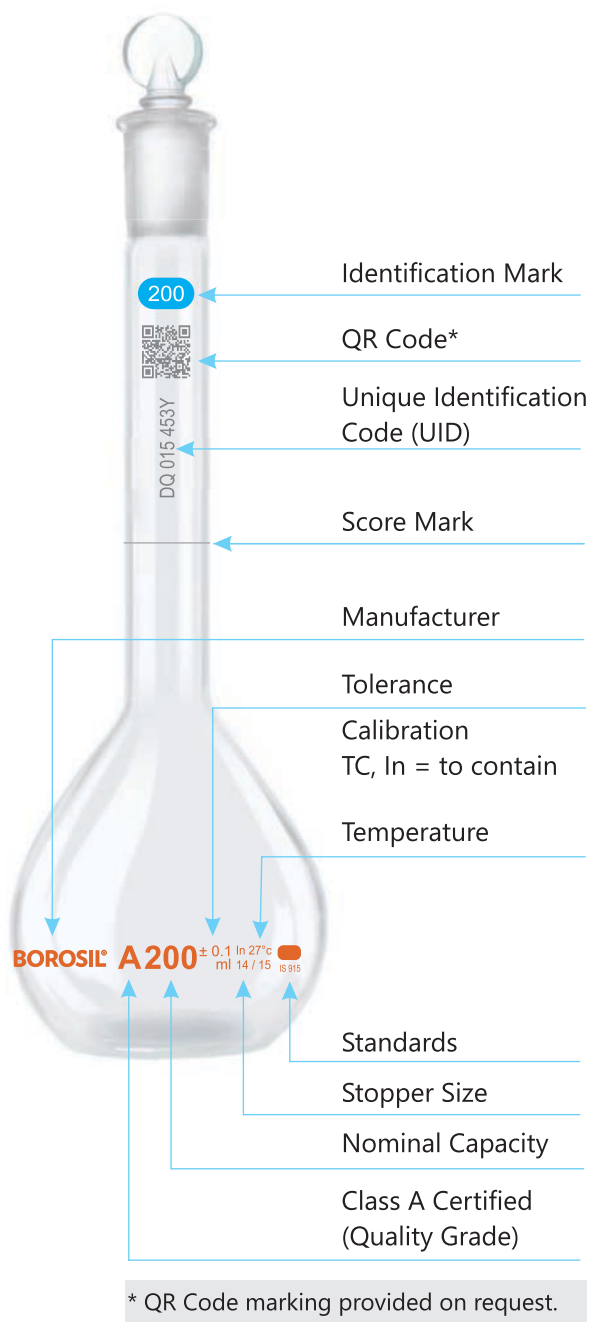

* QR Code marking provided on request.

BOROSIL Volumetric Flasks are designed to give the best combination of thermal shock resistance, physical strength and resistance to chemical attack. They are made to withstand the demands of the modern laboratory and are particularly suitable for all glass apparatus assemblies.

Made from 3.3 Low Expansion Borosilicate Glass



At **BOROSIL** we understand that different needs require different solutions. Hence we offer our clients a wide range of flasks, designed to meet their individual requirements, while ensuring optimum quality.

Calibration

- Every Volumetric Flask is calibrated on fully automatic computer controlled calibration machine, eliminating the manual error in reading the meniscus, thereby giving more accurate volume.
- Each Volumetric Flask is individually calibrated and is provided with Unique Identification Number (UID) and supplied with individual Certificate

Printing

- All Volumetric Flasks are printed with permanent amber colour
- The amber Volumetric Flasks are printed with white ceramic enamel
- Printing is done using advanced printing technology and high quality organic enamels and inks to ensure finest printing quality

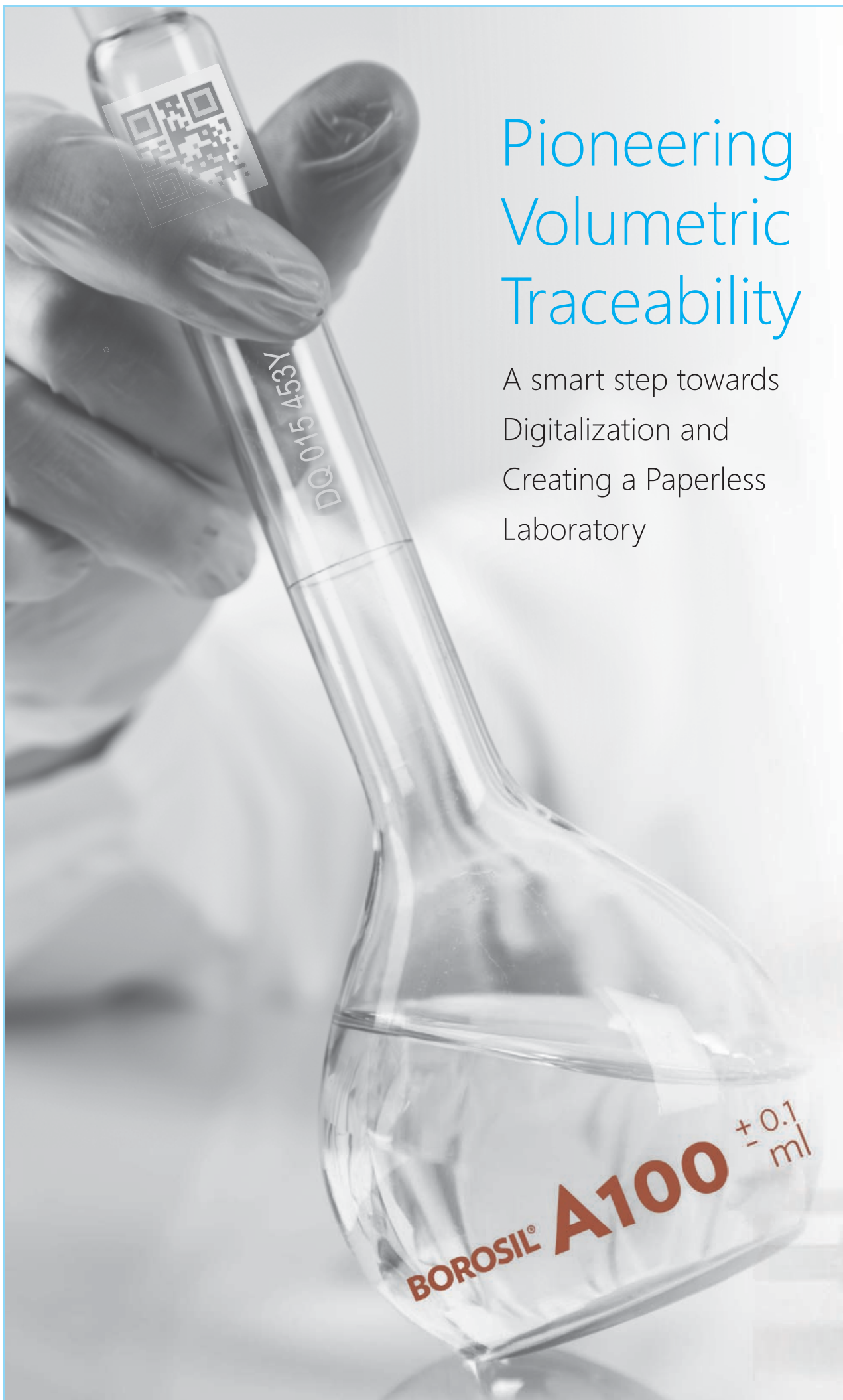

Pioneering Volumetric Traceability

A smart step towards
Digitalization and
Creating a Paperless
Laboratory



Please write to us on
lab.customercare@borosil.com
OR
Contact our
Regional Sales representative



QR Coded Glassware



TRIAL QR CODE



Scan the QR Code
to download
the sample Certificate

- Laser marking of LIMS compatible QR Code
- Easy certificate download
- Direct data transfer into LIMS

State of the art Calibration

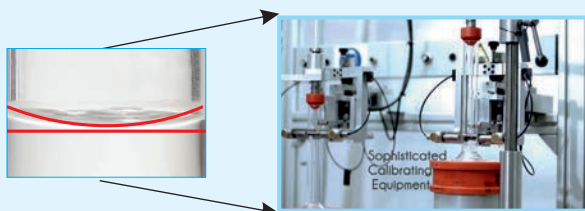

- Laser identification of meniscus
- Actual photo of individual meniscus captured on calibration certificates

Easy to scan QR Code



Download
the certificate

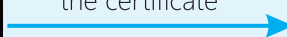

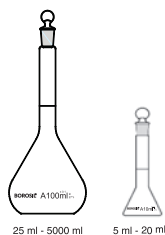

5640 - VOLUMETRIC FLASKS

Class A, Narrow Mouth, Clear, with Individual Calibration Certificate

- Complies with IS 915 / ISO 1042, Accuracy as per class A
- Supplied with Interchangeable Solid Glass Stopper
- Each flask is marked with individual serial number and supplied with certificate of calibration traceable to National standards
- Amber enamel inscriptions
- Calibrated & certified at 27°C

Product Code	Capacity ml	Tolerance ± ml	Stopper Size	Quantity Per Case	Price / Piece ₹
5640001	1	0.025	7 / 16	5	920.00
5640002	2	0.025	7 / 16	5	920.00
5640005	5	0.025	10 / 19 #	5	830.00
5640006	10	0.025	10 / 19 #	5	720.00
5640008	20	0.04	10 / 19	5	720.00
5640009	25	0.04	10 / 19	5	665.00
5640012	50	0.06	12 / 21	10	630.00
5640016	100	0.10	14 / 23	10	615.00
5640020	200	0.15	14 / 23	10	870.00
5640021	250	0.15	14 / 23	10	870.00
5640024	500	0.25	19 / 26	10	1140.00
5640029	1000	0.40	24 / 29	10	1665.00
5640030	2000	0.60	29 / 32	2	2705.00
5640033	5000	1.20	34 / 35	1	13300.00

- 1 ml to 20 ml supplied with trapezoidal shape for better stability
 - # Stopper size as per Borosil Design

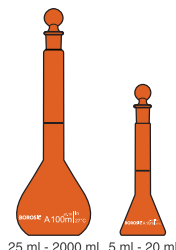

5648 - VOLUMETRIC FLASKS

Class A, Narrow Mouth, Amber, with Individual Calibration Certificate

- Complies with IS 915 / ISO 1042, Accuracy as per class A
- Supplied with Interchangeable Solid Glass Stopper
- Each flask is marked with individual serial number and supplied with certificate of calibration traceable to National standards
- Amber coating on exterior surfaces to facilitate use with light sensitive solutions
- White enamel inscriptions
- Calibrated & certified at 27°C

Product Code	Capacity ml	Tolerance ± ml	Stopper Size	Quantity Per Case	Price / Piece ₹
5648005	5	0.025	10 / 19#	5	990.00
5648006	10	0.025	10 / 19#	5	860.00
5648008	20	0.04	10 / 19	5	860.00
5648009	25	0.04	10 / 19	5	800.00
5648012	50	0.06	12 / 21	10	755.00
5648016	100	0.10	14 / 23	10	745.00
5648020	200	0.15	14 / 23	10	1040.00
5648021	250	0.15	14 / 23	10	1020.00
5648024	500	0.25	19 / 26	10	1365.00
5648029	1000	0.40	24 / 29	10	1990.00
5648030	2000	0.60	29 / 32	2	3240.00

- 5 ml to 20 ml supplied with trapezoidal shape for better stability
 - # Stopper size as per Borosil Design

5643 - VOLUMETRIC FLASKS

Class A, Wide Mouth, Clear, with Individual Calibration Certificate

- Complies with IS 915 / ISO 1042, Accuracy as per class A
- Supplied with Interchangeable Solid Glass Stopper
- Each flask is marked with individual serial number and supplied with certificate of calibration traceable to National standards
- Amber enamel inscriptions
- Specially designed wide mouth for testing bigger diameter tablet without making it in powder form
- Calibrated & certified at 27°C

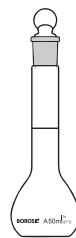

Product Code	Capacity ml	Tolerance ± ml	Stopper Size	Quantity Per Case	Price / Piece ₹
5643005	5	0.04	12 / 21#	5	825.00
5643006	10	0.04	12 / 21#	5	720.00
5643008	20	0.06	12 / 21	5	730.00
5643009	25*	0.06	14 / 23	5	790.00
5643A09	25	0.06	12 / 21	5	790.00
5643012	50	0.10	14 / 23	10	760.00
5643016	100*	0.10	19 / 26	10	800.00
5643020	200*	0.15	19 / 26	10	1050.00
5643021	250*	0.15	19 / 26	10	1120.00
5643029	1000	0.60	29 / 32	10	1730.00

- * Not covered in the standards
- 5 ml to 20 ml supplied with trapezoidal shape for better stability
- # 5 ml & 10 ml (# Stopper size as per borosil design)

5653 - VOLUMETRIC FLASKS

Class A, Wide Mouth, Amber, with Individual Calibration Certificate

- Complies with IS 915 / ISO 1042, Accuracy as per class A
- Supplied with Interchangeable Solid Glass Stopper
- Each flask is marked with individual serial number and supplied with certificate of calibration traceable to National standards
- Amber coating on exterior surfaces to facilitate use with light sensitive solutions
- White enamel inscriptions
- Specially designed wide mouth for testing bigger diameter tablet without making it in powder form
- Calibrated & certified at 27°C



Product Code	Capacity ml	Tolerance ± ml	Stopper Size	Quantity Per Case	Price / Piece ₹
5653005	5	0.04	12 / 21#	5	975.00
5653006	10	0.04	12 / 21#	5	850.00
5653008	20	0.06	12 / 21	5	870.00
5653009	25*	0.06	14 / 23	5	950.00
5653A09	25	0.06	12 / 21	5	950.00
5653012	50	0.10	14 / 23	10	905.00
5653016	100*	0.10	19 / 26	10	985.00
5653020	200*	0.15	19 / 26	10	1260.00
5653021	250*	0.15	19 / 26	10	1910.00
5653029	1000	0.60	29 / 32	10	2050.00

- * Not covered in the standards
- 5 ml to 20 ml supplied with trapezoidal shape for better stability
- # 5 ml & 10 ml (# Stopper size as per borosil design)

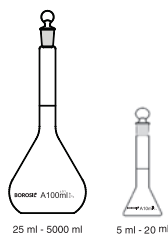

5645D - VOLUMETRIC FLASKS

Class A, USP, Narrow Mouth, Clear, with Individual Calibration Certificate

- Tolerance complies to ASTM E288 standards and dimensions as per ISO 1042 standards
- Supplied with Interchangeable Solid Glass Stopper
- Each flask is marked with individual serial number and supplied with certificate of calibration traceable to National standards
- Amber enamel inscriptions
- Calibrated & certified at 20°C

Product Code	Capacity ml	Tolerance ± ml	Stopper Size	Quantity Per Case	Price / Piece ₹
5645005D	5	0.02	10 / 19#	5	930.00
5645006D	10	0.02	10 / 19#	5	810.00
5645008D	20*	0.03	10 / 19	5	815.00
5645009D	25	0.03	10 / 19	5	745.00
5645012D	50	0.05	12 / 21	10	710.00
5645016D	100	0.08	14 / 23	10	695.00
5645020D	200	0.10	14 / 23	10	975.00
5645021D	250	0.12	14 / 23	10	980.00
5645024D	500	0.20	19 / 26	10	1285.00
5645029D	1000	0.30	24 / 29	10	1870.00
5645030D	2000	0.50	29 / 32	2	3040.00

- 5 ml to 20 ml supplied with trapezoidal shape for better stability
- * Not covered in the standards
- # 5 ml & 10 ml stopper size Stopper size as per borosil design

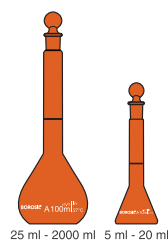

5655D - VOLUMETRIC FLASKS

Class A, USP, Narrow Mouth, Amber, with Individual Calibration Certificate

- Tolerance complies to ASTM E288 standards and dimensions as per ISO 1042 standards
- Supplied with Interchangeable Solid Glass Stopper
- Each flask is marked with individual serial number and supplied with certificate of calibration traceable to National standards
- Amber coating on exterior surfaces to facilitate use with light sensitive solutions
- White enamel inscriptions
- Calibrated & certified at 20°C

Product Code	Capacity ml	Tolerance ± ml	Stopper Size	Quantity Per Case	Price / Piece ₹
5655005D	5	0.02	10 / 19#	5	1110.00
5655006D	10	0.02	10 / 19#	5	975.00
5655008D	20*	0.03	10 / 19	5	975.00
5655009D	25	0.03	10 / 19	5	895.00
5655012D	50	0.05	12 / 21	10	860.00
5655016D	100	0.08	14 / 23	10	840.00
5655020D	200	0.10	14 / 23	10	1185.00
5655021D	250	0.12	14 / 23	10	1190.00
5655024D	500	0.20	19 / 26	10	1570.00
5655029D	1000	0.30	24 / 29	10	2290.00
5655030D	2000	0.50	29 / 32	2	3690.00

- 5 ml to 20 ml supplied with trapezoidal shape for better stability
- * Not covered in the standards
- # 5 ml & 10 ml stopper size not as per standards and kept wide mouth for convenient pipetting

5647D - VOLUMETRIC FLASKS

Class A, USP, Wide Mouth, Clear, with Individual Calibration Certificate

- Tolerance complies to ASTM E288 standards and dimensions as per ISO 1042 standards
- Supplied with Interchangeable Solid Glass Stopper
- Each flask is marked with individual serial number and supplied with certificate of calibration traceable to National standards
- Amber enamel inscriptions
- Specially designed wide mouth for testing bigger diameter tablets without making it in powder form
- Calibrated & certified at 20°C

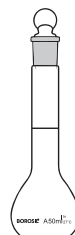

Product Code	Capacity ml	Tolerance ± ml	Stopper Size	Quantity Per Case	Price / Piece ₹
5647005D	5	0.08	12 / 21#	5	885.00
5647006D	10	0.08	12 / 21#	5	765.00
5647008D	20	0.08	12 / 21	5	790.00
5647009D	25	0.08	12 / 21	5	845.00
5647012D	50	0.08	14 / 23	10	825.00
5647016D	100*	0.10	19 / 26	10	870.00
5647020D	200*	0.20	19 / 26	10	1020.00
5647021D	250*	0.20	19 / 26	10	1100.00

- * Not covered in the standards
- 5 ml to 20 ml supplied with trapezoidal shape for better stability
- # Stopper size as per Borosil Design

5657D - VOLUMETRIC FLASKS

Class A, USP, Wide Mouth, Amber, with Individual Calibration Certificate

- Tolerance complies to ASTM E288 standards and dimensions as per ISO 1042 standards
- Supplied with Interchangeable Solid Glass Stopper
- Each flask is marked with individual serial number and supplied with certificate of calibration traceable to National standards
- Amber coating on exterior surfaces to facilitate use with light sensitive solutions
- White enamel inscriptions
- Specially designed wide mouth for testing bigger diameter tablets without making it in powder form
- Calibrated & certified at 20°C



Product Code	Capacity ml	Tolerance ± ml	Stopper Size	Quantity Per Case	Price / Piece ₹
5657005D	5	0.08	12 / 21#	5	1080.00
5657006D	10	0.08	12 / 21#	5	930.00
5657008D	20	0.08	12 / 21	5	930.00
5657009D	25	0.08	12 / 21	5	1010.00
5657012D	50	0.08	14 / 23	10	990.00
5657016D	100*	0.10	19 / 26	10	1045.00
5657020D	200*	0.20	19 / 26	10	1230.00
5657021D	250*	0.20	19 / 26	10	1335.00

- * Not covered in the standards
- 5 ml to 20 ml supplied with trapezoidal shape for better stability
- # Stopper size as per Borosil Design

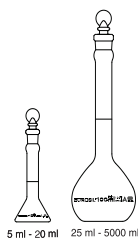

5645 - VOLUMETRIC FLASKS

ASTM, Narrow Mouth, Clear, with Individual Calibration Certificate

- Complies fully with ASTM E 288 standards - For both dimensions as well as tolerance
- Supplied with Interchangeable Solid Glass Stopper
- Each flask is marked with individual serial number and supplied with certificate of calibration traceable to National standards
- Amber enamel inscriptions
- Calibrated & certified at 20°C

Product Code	Capacity ml	Tolerance ± ml	Stopper Size	Quantity Per Case	Price / Piece ₹
5645005	5	0.02	9	5	930.00
5645006	10	0.02	9	5	810.00
5645008	20*	0.03	9	5	815.00
5645009	25	0.03	9	5	745.00
5645012	50	0.05	9	10	710.00
5645016	100	0.08	13	10	695.00
5645020	200	0.10	16	10	975.00
5645021	250	0.12	16	10	980.00
5645024	500	0.20	19	10	1285.00
5645029	1000	0.30	22	10	1870.00
5645030	2000	0.50	27	2	3040.00

- 5 ml to 20 ml supplied with trapezoidal shape for better stability
- * Not covered in the standards
- For Stopper dimensions refer page no. 36

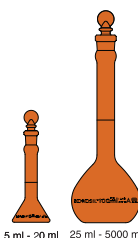

5655 - VOLUMETRIC FLASKS

ASTM, Narrow Mouth, Amber, with Individual Calibration Certificate

- Complies fully with ASTM E 288 standards - For both dimensions as well as tolerance
- Supplied with Interchangeable Solid Glass Stopper
- Each flask is marked with individual serial number and supplied with certificate of calibration traceable to National standards
- Amber coating on exterior surfaces to facilitate use with light sensitive solutions
- White enamel inscriptions
- Calibrated & certified at 20°C

Product Code	Capacity ml	Tolerance ± ml	Stopper Size	Quantity Per Case	Price / Piece ₹
5655005	5	0.02	9	5	1110.00
5655006	10	0.02	9	5	975.00
5655008	20*	0.03	9	5	975.00
5655009	25	0.03	9	5	895.00
5655012	50	0.05	9	10	860.00
5655016	100	0.08	13	10	840.00
5655020	200	0.10	16	10	1185.00
5655021	250	0.12	16	10	1190.00
5655024	500	0.20	19	10	1570.00
5655029	1000	0.30	22	10	2290.00
5655030	2000	0.50	27	2	3690.00

- 5 ml to 20 ml supplied with trapezoidal shape for better stability
- * Not covered in standards
- For Stopper dimensions refer page no. 36

5647 - VOLUMETRIC FLASKS

ASTM, Wide Mouth, Clear, with Individual Calibration Certificate

- Complies fully with ASTM E 288 standards - For both dimensions as well as tolerance
- Supplied with Interchangeable Solid Glass Stopper
- Each flask is marked with individual serial number and supplied with certificate of calibration traceable to National standards
- Amber enamel inscriptions
- Specially designed wide mouth for testing bigger diameter tablets without making it in powder form
- Calibrated & certified at 20°C

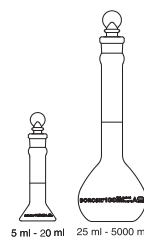

Product Code	Capacity ml	Tolerance ± ml	Stopper Size	Quantity Per Case	Price / Piece ₹
5647005	5	0.08	13	5	885.00
5647006	10	0.08	13	5	765.00
5647008	20*	0.08	13	5	790.00
5647009	25	0.08	13	5	845.00
5647012	50	0.08	13	10	825.00
5647016	100	0.10	16	10	870.00
5647020	200	0.20	19	10	1020.00
5647021	250	0.20	19	10	1100.00

- 5 ml to 20 ml supplied with trapezoidal shape for better stability

- * Not covered in the standards

- For Stopper dimensions refer page no. 36



5657 - VOLUMETRIC FLASKS

ASTM, Wide Mouth, Amber, with Individual Calibration Certificate

- Complies fully with ASTM E 288 standards - For both dimensions as well as tolerance
- Supplied with Interchangeable Solid Glass Stopper
- Each flask is marked with individual serial number and supplied with certificate of calibration traceable to National standards
- Amber coating on exterior surfaces to facilitate use with light sensitive solutions
- White enamel inscriptions
- Specially designed wide mouth for testing bigger diameter tablets without making it in powder form
- Calibrated & certified at 20°C

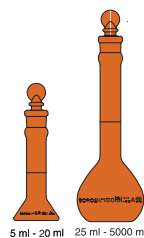

Product Code	Capacity ml	Tolerance ± ml	Stopper Size	Quantity Per Case	Price / Piece ₹
5657005	5	0.08	13	5	1080.00
5657006	10	0.08	13	5	930.00
5657008	20*	0.08	13	5	930.00
5657009	25	0.08	13	5	1010.00
5657012	50	0.08	13	10	990.00
5657016	100	0.10	16	10	1045.00
5657020	200	0.20	19	10	1230.00
5657021	250	0.20	19	10	1335.00

- * Not covered in the standards

- 5 ml to 20 ml supplied with trapezoidal shape for better stability

- For Stopper dimensions refer page no. 36



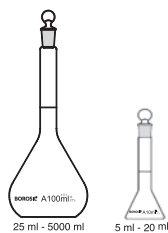

5641 - VOLUMETRIC FLASKS

Class B, Narrow Mouth, Clear

- Complies with IS 915 / ISO 1042, Accuracy as per class B
- Supplied with interchangeable glass stopper
- Amber enamel inscriptions
- Calibrated at 27°C

Product Code	Capacity ml	Tolerance ± ml	Stopper Size	Quantity Per Case	Price / Piece ₹
5641001	1	0.05	7 / 16	10	290.00
5641002	2	0.05	7 / 16	10	290.00
5641005	5	0.05	10 / 19#	10	260.00
5641006	10	0.05	10 / 19#	10	245.00
5641008	20	0.08	10 / 19	10	245.00
5641009	25	0.08	10 / 19	10	240.00
5641012	50	0.12	12 / 21	10	260.00
5641016	100	0.20	14 / 23	10	295.00
5641020	200	0.30	14 / 23	10	340.00
5641021	250	0.30	14 / 23	10	350.00
5641024	500	0.50	19 / 26	10	490.00
5641029	1000	0.80	24 / 29	10	750.00
5641030	2000	1.20	29 / 32	2	1670.00
5641033	5000	2.40	34 / 35	1	5990.00

- 1 ml to 20 ml supplied with trapezoidal shape for better stability
- Certified and Calibrated at 27°C
- # Stopper size as per Borosil Design

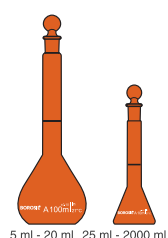

5649 - VOLUMETRIC FLASKS

Class B, Narrow Mouth, Amber

- Complies with IS 915 / ISO 1042, Accuracy as pe class B
- Supplied with interchangeable glass stopper
- Amber coating on exterior surfaces to facilitate use with light sensitive solutions
- White enamel inscriptions
- Calibrated at 27°C

Product Code	Capacity ml	Tolerance ± ml	Stopper Size	Quantity Per Case	Price / Piece ₹
5649005	5	0.05	10 / 19#	10	400.00
5649006	10	0.05	10 / 19#	10	380.00
5649008	20	0.08	10 / 19	10	380.00
5649009	25	0.08	10 / 19	10	380.00
5649012	50	0.12	12 / 21	10	400.00
5649016	100	0.20	14 / 23	10	420.00
5649020	200	0.30	14 / 23	10	490.00
5649021	250	0.30	14 / 23	10	500.00
5649024	500	0.50	19 / 26	10	750.00
5649029	1000	0.80	24 / 29	10	1230.00
5649030	2000	1.20	29 / 32	2	2440.00

- 5 ml to 20 ml supplied with trapezoidal shape for better stability
- Certified and Calibrated at 27°C
- # Stopper size as per Borosil Design

5650 - VOLUMETRIC FLASKS

For Sugar Estimation, Clear

- Complies with BS 675
- Supplied without stopper
- A two mark flask designed for the analysis of sugar solutions. The two



Product Code	Capacity ml	Tolerance \pm ml	Quantity Per Case	Price / Piece ₹
5650016	100 / 110	0.15	20	380.00

Trapezoidal Volumetric Flask

Volumetric flasks with small capacities can be topple down more easily due to their higher centre of gravity.

Trapezoidal volumetric flasks have much larger base area which ensures higher stability. It has atleast twice base area compare to standard volumetric flask of the same capacity.



8100 - Glass Stoppers

Penny head, Clear

Product Code	Stopper Number	Interchangeable Joint Size	Quantity Per Case	Price / Piece ₹
ISO / DIN Standard (Long Neck)				
8100A10	–	10 / 19	20	90.00
8100A12	–	12 / 21	20	95.00
8100A14	–	14 / 23	20	95.00
8100A19	–	19 / 26	20	110.00
8100A24	–	24 / 29	20	210.00
8100A29	–	29 / 32	20	255.00
8100A34	–	34 / 35	20	270.00
ASTM Standard (Short Neck)				
8110008	# 8	8.25 / 10	20	90.00
8110009	# 9	9.4 / 14	20	100.00
8110013	# 13	13.4 / 14	20	110.00
8110016	# 16	16.5 / 15	20	210.00
8110019	# 19	19.7 / 17	20	255.00
8110022	# 22	22.05 / 20.5	20	270.00
8110027	# 27	27.15 / 21.5	20	280.00
IS Standard as per Old design (Till the stocks last)				
8100010	–	10 / 15	20	90.00
8100014	–	14 / 15	20	95.00
8100019	–	19 / 20	20	110.00
8100024	–	24 / 25	20	210.00



8400 - Glass Stoppers

Penny head, Amber

- With Interchangeable Ground Joint

Product Code	Stopper Number	Interchangeable Joint Size	Quantity Per Case	Price / Piece ₹
ISO / DIN Standard (Long Neck)				
8400A10	–	10 / 19	20	110.00
8400A12	–	12 / 21	20	140.00
8400A14	–	14 / 23	20	140.00
8400A19	–	19 / 26	20	160.00
8400A24	–	24 / 29	20	250.00
8400A29	–	29 / 32	20	295.00
8400A34	–	34 / 35	20	320.00
ASTM Standard				
8410008	# 8	8.25 / 10	20	110.00
8410009	# 9	9.4 / 14	20	120.00
8410013	# 13	13.4 / 14	20	135.00
8410016	# 16	16.5 / 15	20	250.00
8410019	# 19	19.7 / 17	20	305.00
8410022	# 22	22.05 / 20.5	20	325.00
8410027	# 27	27.15 / 21.5	20	335.00
IS Standard as per Old design (Till the stocks last)				
8400010	–	10 / 15	20	110.00
8400014	–	14 / 15	20	140.00
8400019	–	19 / 20	20	160.00
8400024	–	24 / 25	20	250.00

Plastic Stopper - ISO, except ASTM
Stock on order

7200 - GLASS WEIGHING SCOOP

- Weighing scoops have an open tubular arm.
- Ideal for weighing small quantities of dyes and powders



Product Code	Capacity ml	Quantity Per Case	Price / Piece ₹
7200P45	0.5	10	240.00
7200001	1	10	215.00
7200002	2	10	215.00
7200003	3	10	205.00
7200076	6	10	225.00
7200006	10	10	260.00

9913 - SAMPLING & STORAGE VIALS

Working Standard Storage Vials

- Made of 5.1 expansion borosilicate glass conforming to USP type I, ASTM E438
- Supplied with high quality polypropylene cap with a PTFE liner, autoclavable at 121°C
- Write on patch for easy labelling and identification
- Complies glass composition and spectral transmission test as per USP chapter 660 USP 40 ad EP 9.0
- Packed in ISO "Class 8" clean room facility
- Amber colour protects light sensitive materials
- Ideal for storage of working standards, sampling of raw materials, chemical and biological samples



Product Code	Capacity ml	Approx Mouth ID in mm	Dimension O.D. x Length in mm	Case Lot (MOQ)	Price Per Piece ₹
9913003	3	10	16 x 36	1050	30.00
9913005	5	10	16 x 55	1050	35.00
9913006	10	16.5	24 x 50	600	50.00
9913007	15	16.5	24 x 58	600	55.00
9913008	20	16.5	24 x 70	600	70.00
9913010	30	16.5	24 x 95	600	80.00

Pipettes

BOROSIL® Pipettes are made from heavy walled, machine drawn borosilicate glass tubing, of precise bore sizes, to provide highest level of accuracy. The mouthpiece of pipettes, of capacities >5ml are tooled with uniform OD for easy aspiration of liquids. Tooling imparts additional strength to the pipettes.

- Individually calibrated by automatic calibration process
- Available in both Class A and Class B tolerances
- Individual calibration certificate provided for Class A pipettes
- Graduation markings made using finest quality white enamel or amber ink to ensure maximum durability
- Color coded in accordance with ISO standards to facilitate easy identification
- Chip resistant bevelled ground edges
- Pipettes can be autoclaved or flame sterilized as per requirement

Made from 3.3 Low Expansion Borosilicate Glass



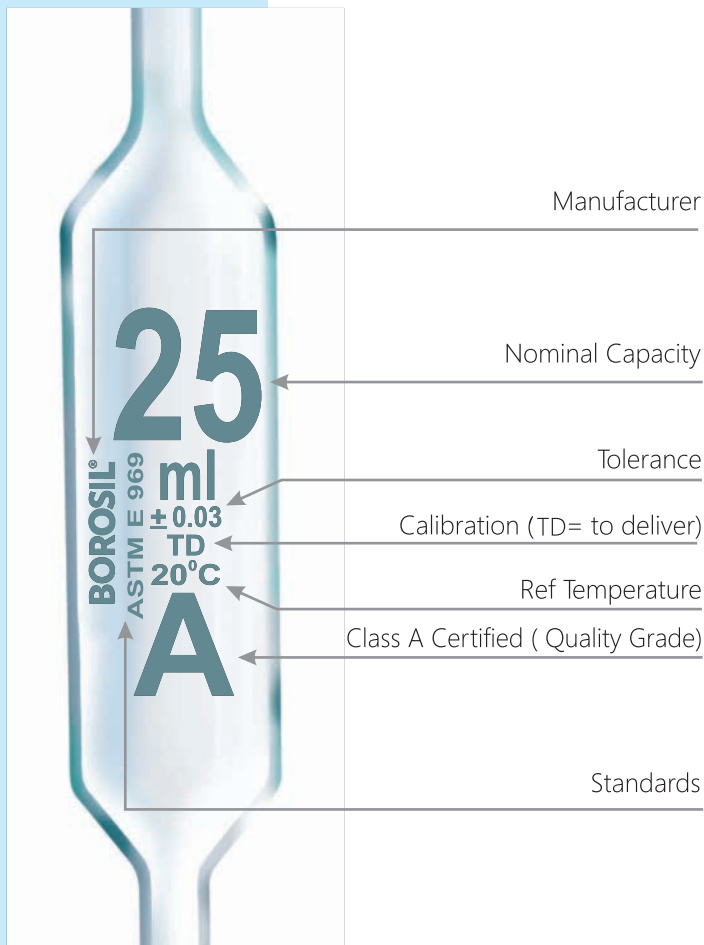

Mohr Type

Delivery from zero mark to the last graduation mark



Serological Type

Delivery from zero mark to the tip

Two Rings

Two rings at the top indicate that pipettes are calibrated to deliver their total capacity



Tips are carefully tooled to ensure proper flow rates
 Tip edges are fire polished



All pipettes are colour coded for quick identification



7100 - VOLUMETRIC PIPETTES

Class A, with Individual Calibration Certificate

- Complies with ISO 648
- Calibrated for delivery (TD, Ex)
- Each pipette coded with unique identification number (UID) and supplied with calibration certificate with traceability to national standards
- Generally used for accurate measurement and decanting of liquid
- Calibrated and certified at 27°C

Product Code	Capacity ml	Tolerance ± ml	Quantity Per Case	Price / Piece ₹
7100001	1	0.008	10	330.00
7100002	2	0.01	10	335.00
7100005	5	0.015	10	380.00
7100006	10	0.02	10	455.00
7100008	20	0.03	10	590.00
7100009	25	0.03	10	630.00
7100012	50	0.05	10	715.00
7100016	100	0.08	10	1075.00



7101 - VOLUMETRIC PIPETTES

Class A, ASTM with Individual Calibration Certificate

- Complies with ASTM E-969-02
- Calibrated for delivery (TD, Ex)
- Each pipette coded with unique identification number (UID) and supplied with calibration certificate with traceability to national standards
- Generally used for accurate measurement and decanting of liquid
- Calibrated and certified at 20°C

Product Code	Capacity ml	Tolerance ± ml	Quantity Per Case	Price / Piece ₹
7101001	1	0.006	10	335.00
7101105	1.5*	0.006	10	380.00
7101002	2	0.006	10	380.00
7101205	2.5*	0.01	10	420.00
7101003	3	0.01	10	395.00
7101004	4	0.01	10	395.00
7101005	5	0.01	10	400.00
7101706	6	0.01	10	440.00
7101707	7	0.01	10	440.00
7101708	8	0.02	10	440.00
7101709	9	0.02	10	440.00
7101006	10	0.02	10	455.00
7101007	15	0.03	10	515.00
7101008	20	0.03	10	595.00
7101009	25	0.03	10	630.00
7101010	30	0.03	10	630.00
7101011	40	0.05	10	665.00
7101012	50	0.05	10	725.00
7101016	100	0.08	10	1090.00

* As per Borosil standard

7106 - VOLUMETRIC PIPETTES

Class A, ASTM, Amber, with Individual Calibration Certificate

- Complies with ASTM E-969-02
- Calibrated for delivery (TD, Ex)
- Each pipette coded with unique identification number (UID) and supplied with calibration certificate with traceability to national standards
- Uniform amber colour protects liquids from light radiation with a wave-length between 300 nm and 500 nm
- Ideal for use with light-sensitive solutions
- Generally used for accurate measurement and decanting of liquid
- Calibrated and certified at 20°C



Product Code	Capacity ml	Tolerance ± ml	Quantity Per Case	Price / Piece ₹
7106001	1	0.006	10	570.00
7106002	2	0.006	10	570.00
7106005	5	0.01	10	630.00
7106006	10	0.02	10	645.00
7106008	20	0.03	10	700.00
7106009	25	0.03	10	700.00
7106012	50	0.05	10	820.00
7106016	100	0.08	10	1090.00

7102 - VOLUMETRIC PIPETTES

Class B

- Complies with ISO 648
- Calibrated for delivery (TD, Ex)
- Generally used for accurate measurement and decanting of liquid
- Calibrated at 27°C



Product Code	Capacity ml	Tolerance ± ml	Quantity Per Case	Price / Piece ₹
7102001	1	0.015	10	165.00
7102002	2	0.02	10	170.00
7102003	3*	0.02	10	170.00
7102004	4*	0.02	10	170.00
7102005	5	0.03	10	170.00
7102706	6*	0.03	10	190.00
7102707	7*	0.03	10	190.00
7102708	8*	0.04	10	190.00
7102709	9*	0.04	10	190.00
7102006	10	0.04	10	200.00
7102007	15*	0.06	10	230.00
7102008	20	0.06	10	230.00
7102009	25	0.06	10	240.00
7102010	30*	0.06	10	240.00
7102011	40*	0.1	10	265.00
7102012	50	0.1	10	275.00
7102016	100	0.15	10	415.00

* As per Borosil standard



7103 - VOLUMETRIC PIPETTES

Class B, ASTM

- Complies with ASTM E-969-02
- Calibrated for delivery (TD, Ex)
- Generally used for accurate measurement and decanting of liquid
- Calibrated at 20°C

Till stock lasts				
Product Code	Capacity ml	Tolerance ± ml	Quantity Per Case	Price / Piece ₹
7103001	1	0.012	10	165.00
7103002	2	0.012	10	170.00
7103003	3	0.02	10	170.00
7103004	4	0.02	10	170.00
7103005	5	0.02	10	170.00
7103706	6	0.03	10	190.00
7103707	7	0.03	10	190.00
7103708	8	0.04	10	190.00
7103709	9	0.04	10	190.00
7103006	10	0.04	10	200.00
7103007	15	0.06	10	230.00
7103008	20	0.06	10	230.00
7103009	25	0.06	10	240.00
7103010	30*	0.06	10	240.00
7103011	40*	0.10	10	265.00
7103012	50	0.10	10	275.00
7103016	100	0.16	10	415.00

* As per Borosil standard

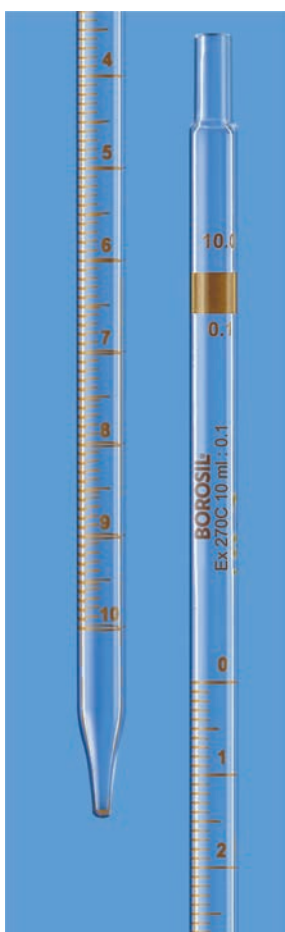

7059 - MOHR PIPETTES

Class A, with Individual Calibration Certificate

- Complies with IS, ISO 835, Type I
- Graduated for delivery from zero mark to the last graduation mark
- Supplied with individual calibration certificate showing actual volume dispensed and providing traceability to national standards
- Markings are made in permanent amber stain diffused into the surface of the glass for better visibility and durability
- Calibrated and certified at 27°C

Product Code	Capacity ml	Graduation Interval ml	Tolerance +/- ml	Quantity per Case	Price / Piece ₹
7059P41	0.1	0.01	0.006	10	510.00
7059P42	0.2	0.01	0.006	10	510.00
7059P01	1	0.01	0.007	10	475.00
7059P11	1	0.10	0.007	10	420.00
7059P02	2	0.02	0.01	10	470.00
7059P22	2	0.10	0.01	10	440.00
7059P05	5	0.05	0.03	10	545.00
7059P55	5	0.10	0.03	10	510.00
7059P06	10	0.10	0.05	10	585.00
7059P09	25	0.20	0.10	10	690.00

7060 - MOHR PIPETTES

Class B

- Complies with IS, ISO 835, Type I
- Graduated for delivery from zero mark to the last graduation mark
- Markings are made in permanent amber stain diffused into the surface of the glass for better visibility and durability
- Calibrated at 27°C



Product Code	Capacity ml	Graduation Interval ml	Tolerance +/- ml	Quantity Per Case	Price / Piece ₹
7060P41	0.1	0.01	0.01	20	170.00
7060P42	0.2	0.01	0.01	20	160.00
7060P01	1	0.01	0.01	20	160.00
7060P11	1	0.10	0.01	20	150.00
7060P02	2	0.02	0.02	20	170.00
7060P22	2	0.10	0.02	20	160.00
7060P05	5	0.05	0.05	20	180.00
7060P55	5	0.10	0.05	20	170.00
7060P06	10	0.10	0.10	20	195.00
7060P09	25	0.20	0.20	20	300.00

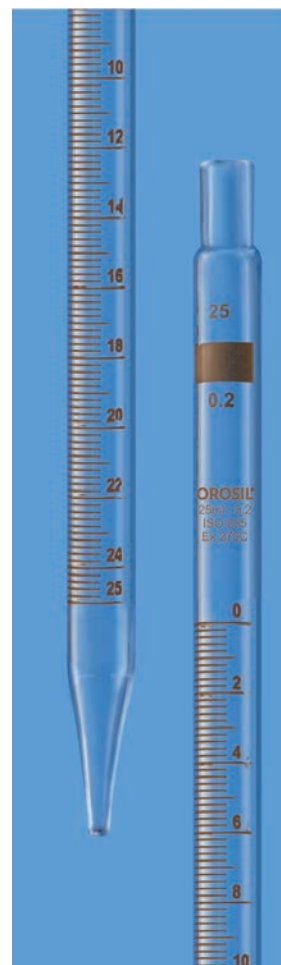

7062 - MOHR PIPETTES

Class B, White Marking

- Complies with ISO 835
- Graduated for delivery from zero mark to the last graduation mark
- Graduation in white enamel for increased visibility against dark solutions
- Calibrated at 27°C



Product Code	Capacity ml	Graduation Interval ml	Tolerance ± ml	Quantity Per Case	Price / Piece ₹
7062P41	0.1	0.01	0.01	20	170.00
7062P42	0.2	0.01	0.01	20	160.00
7062P01	1	0.01	0.01	20	160.00
7062P11	1	0.10	0.01	20	150.00
7062P02	2	0.02	0.02	20	170.00
7062P22	2	0.10	0.02	20	160.00
7062P05	5	0.05	0.05	20	180.00
7062P55	5	0.10	0.05	20	170.00
7062P06	10	0.10	0.10	20	195.00
7062P09	25	0.20	0.20	20	300.00

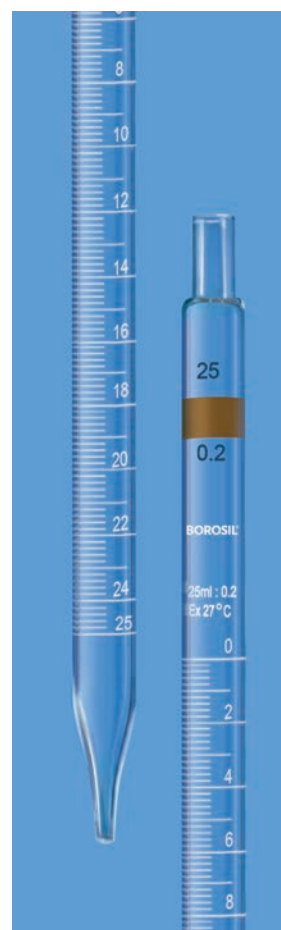

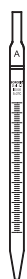

7079 - SEROLOGICAL PIPETTES

Class A, With Individual Calibration Certificate

- Complies with IS, ISO 835, Type III total delivery
- These Pipettes are graduated to the tip
- Two rings at the top indicate that the Pipette is calibrated to deliver from any graduation line down to tip
- Supplied with individual calibration certificate showing actual volume dispensed and providing traceability to national standards
- Markings are made in permanent amber stain diffused into the surface of the glass for better visibility and durability
- Calibrated and certified at 27°C

Product Code	Capacity ml	Graduation Interval ml	Tolerance \pm ml	Quantity Per Case	Price / Piece ₹
7079P41	0.1	0.01	0.006	10	510.00
7079P42	0.2	0.01	0.006	10	510.00
7079P01	1	0.01	0.007	10	580.00
7079P11	1	0.10	0.007	10	420.00
7079P02	2	0.02	0.01	10	470.00
7079P22	2	0.10	0.01	10	440.00
7079P05	5	0.05	0.03	10	545.00
7079P55	5	0.10	0.03	10	510.00
7079P06	10	0.10	0.05	10	585.00
7079P09	25	0.20	0.10	10	690.00

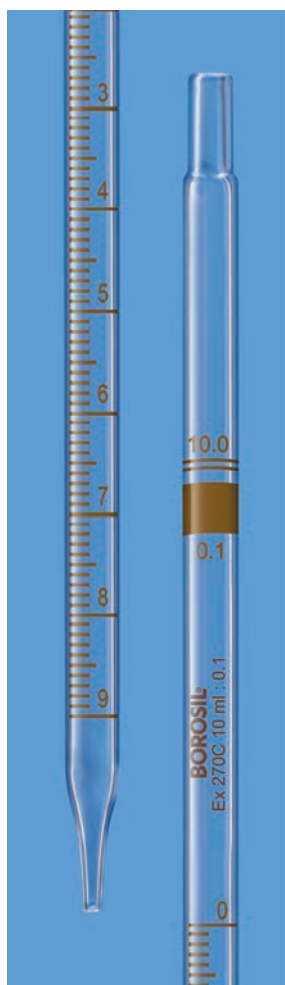

7080 - SEROLOGICAL PIPETTES

Class B

- Complies with IS, ISO 835
- These Pipettes are graduated to the tip
- Two rings at the top indicate that the Pipette is calibrated to deliver from any graduation line down to tip
- Markings are made in permanent amber stain diffused into the surface of the glass for better visibility and durability
- Calibrated at 27°C

Product Code	Capacity ml	Graduation Interval ml	Tolerance \pm ml	Quantity Per Case	Price / Piece ₹
7080P41	0.1	0.01	0.01	20	170.00
7080P42	0.2	0.01	0.01	20	160.00
7080P01	1	0.01	0.01	20	160.00
7080P11	1	0.10	0.01	20	150.00
7080P02	2	0.02	0.02	20	170.00
7080P22	2	0.10	0.02	20	160.00
7080P05	5	0.05	0.05	20	180.00
7080P55	5	0.10	0.05	20	170.00
7080P06	10	0.10	0.10	20	195.00
7080P09	25	0.20	0.20	20	300.00

7082 - SEROLOGICAL PIPETTES

Class B, White marking

- Complies with IS, ISO 835
- These Pipettes are graduated to the tip
- Two rings at the top indicate that the Pipette is calibrated to deliver from any graduation line down to tip
- Graduation in white enamel for increased visibility against dark solutions
- Calibrated at 27°C



Product Code	Capacity ml	Graduation Interval ml	Tolerance \pm ml	Quantity Per Case	Price / Piece ₹
7082P41	0.1	0.01	0.01	20	170.00
7082P42	0.2	0.01	0.01	20	160.00
7082P01	1	0.01	0.01	20	160.00
7082P11	1	0.10	0.01	20	150.00
7082P02	2	0.02	0.02	20	170.00
7082P22	2	0.10	0.02	20	160.00
7082P05	5	0.05	0.05	20	180.00
7082P55	5	0.10	0.05	20	170.00
7082P06	10	0.10	0.10	20	195.00
7082P09	25	0.20	0.20	20	300.00

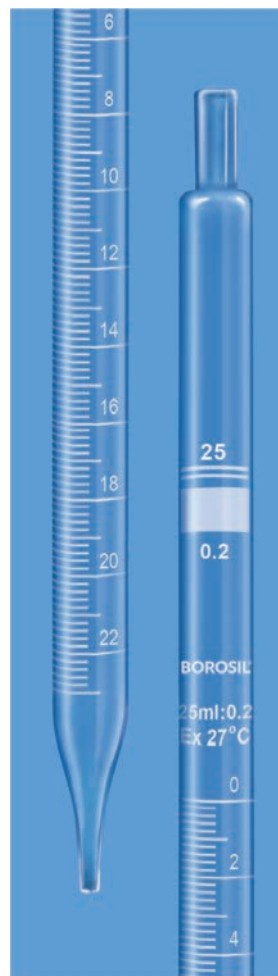

7081 - SEROLOGICAL PIPETTES

Class A, USP, With Individual Calibration Certificate

- Complies with ASTM 1293 - 02
- These pipettes are graduated to the tip
- Two rings at the top indicate that the pipette is calibrated to deliver from any graduation line down to tip
- Supplied with individual calibration certificate showing actual volume dispensed and providing traceability to national standards
- Markings are made in permanent amber stain diffused into the surface of the glass for better visibility and durability
- Calibrated and certified at 20°C



Product Code	Capacity ml	Graduation Interval ml	Tolerance \pm ml	Quantity Per Case	Price / Piece ₹
7081P01	1	0.01	0.01	10	460.00
7081P11	1	0.10	0.01	10	430.00
7081P22	2	0.10	0.01	10	460.00
7081P55	5	0.10	0.02	10	550.00
7081P06	10	0.10	0.03	10	595.00
7081P09	25	0.10	0.05	10	700.00

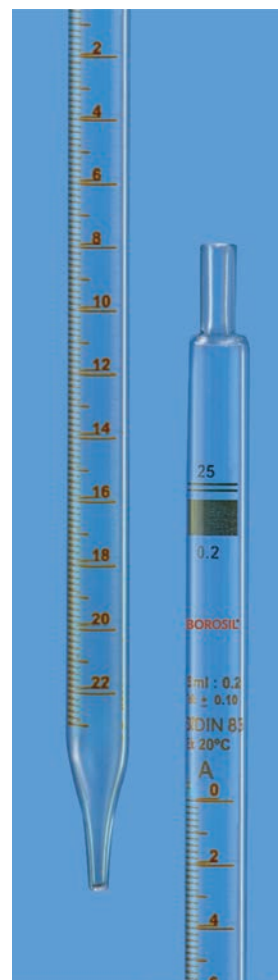

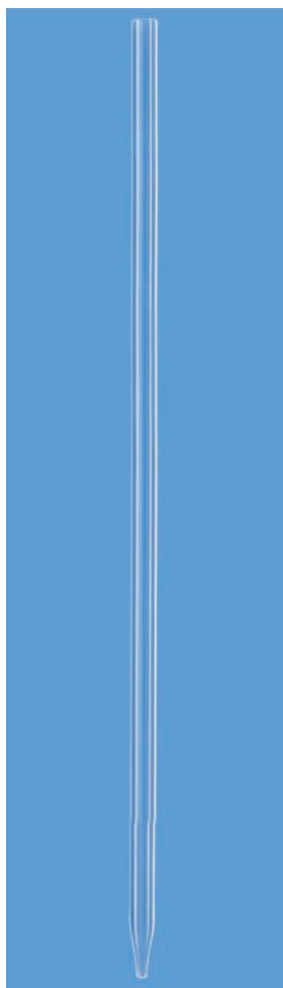

7040 - ARTIFICIAL INSEMINATION PIPETTES

- Sturdy, strong and safe for repeated use
- It can be sterilised and cleaned easily
- Tapered tip for efficient use
- Ideal for artificial insemination in cattles

Product Code	Length mm	Quantity Per Case	Price / Piece ₹
7040162	450	60	100.00

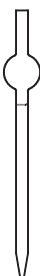
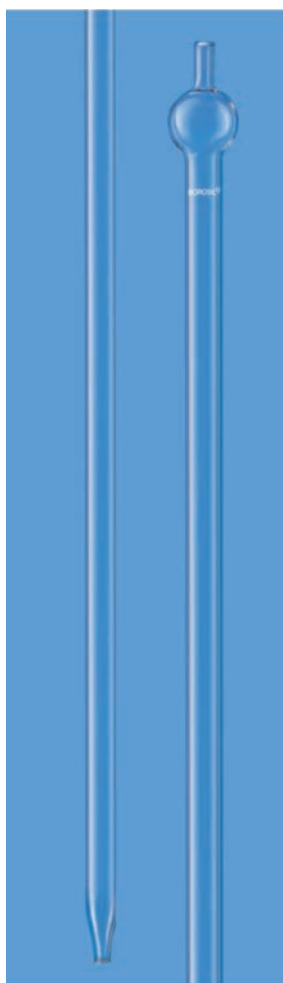

7041 - DRUM SAMPLING PIPETTE

Product Code	Length mm	Quantity Per Case	Price / Piece ₹
7041041	1000	4	515.00

7056 - MILK/BACTERIOLOGICAL PIPETTES

- Complies with IS 2025
- Available in two capacities - 1.1ml and 2.2 ml
- 1.1 ml is graduated at 0.5 to 1.1 ml
- 2.2 ml is graduated at 1.0, 2.0, 2.1 and 2.2 ml
- Used for the bacteriological examination of milk in dairy industries



Product Code	Capacity ml	Tolerance \pm ml	Quantity Per Case	Price / Piece ₹
7056101	1.1	0.025	10	185.00
7056102	2.2	0.040	10	205.00

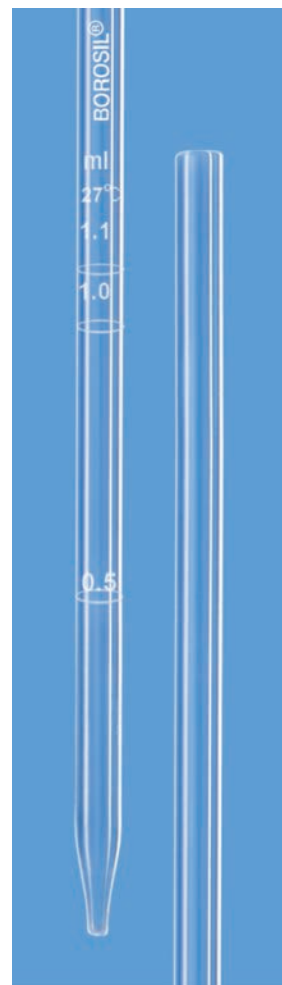

7057 - GERBER MILK PIPETTES

- Complies with IS 1223 (Part II)
- Sturdy, designed to last long
- Used for testing milk by the Gerber method
- Gerber Milk Pipettes are one-mark transfer Pipettes for measuring 10.75 ml
- They can be also be used in rural Milk Collection Centres



Product Code	Capacity ml	Tolerance \pm ml	Quantity Per Case	Price / Piece ₹
7057P10	10.75	0.03	10	195.00



7058 - GERBER MILK PIPETTES with Certificate

- Provided with calibration certificate

Product Code	Capacity ml	Tolerance \pm ml	Quantity Per Case	Price / Piece ₹
7058P10	10.75	0.015	10	405.00

Cylinders

Measuring cylinders are the most common and essential measuring devices used in any laboratory. **BOROSIL**® Cylinders are made from heavy walled, machine drawn borosilicate glass tubing which makes them sturdy for daily laboratory use.

BOROSIL® offers cylinders from capacities 5ml to 2000ml, with penny head stoppers or cylinders without stoppers.

Made from 3.3 Low Expansion Borosilicate Glass



- Complies with highest quality standards according to IS 878, ASTM E1272 and ISO 4788
- All measuring cylinders are calibrated to contain (TC, In) and all tolerances are according to IS / ISO / DIN / ASTM class " A " Standards
- Individually calibrated on automatic calibration machine
- Available in both Class A and Class B tolerances
- Individual calibration certificate provided for Class A pipettes
- Graduation markings made using finest quality white enamel or amber ink to ensure maximum durability
- Stringent control throughout the process of manufacturing and quality checks minimizes the possibility of deviations
- Specially designed with hexagonal base for enhance stability
- Spout allows drip free pouring

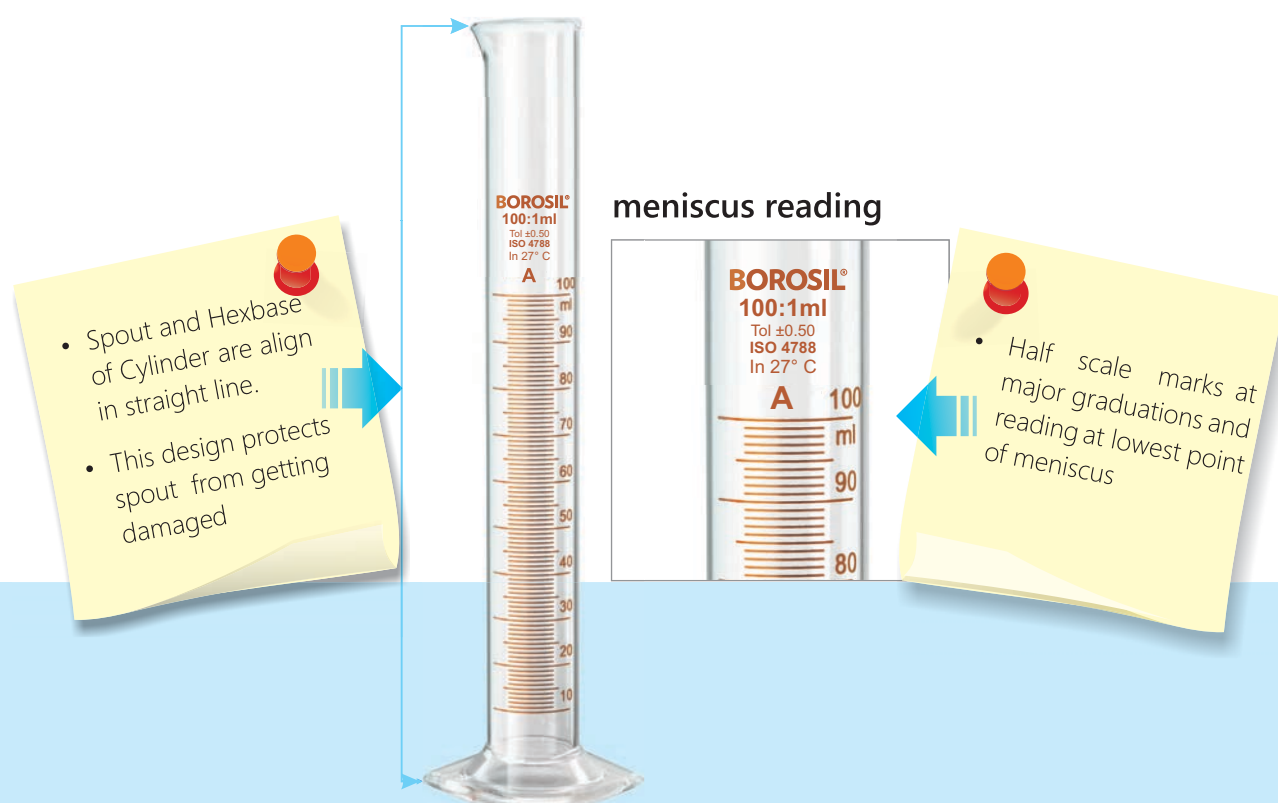



2981 - CYLINDERS

Class A, Hexagonal Base, with I/C Stopper, with Individual Calibration Certificate

- Complies with IS 878, ISO 4788
- Supplied with Interchangeable Penny head Stopper
- Graduated, Single Metric Scale
- Each cylinder is engraved with a unique serial number, and comes with a Certificate of Calibration traceable to national standards
- Graduations in amber enamel
- Sturdy hexagonal base prevents roll-over and ensures greater stability
- Calibrated and certified at 27°C

Product Code	Capacity ml	Graduation Interval ml	Tolerance \pm ml	Stopper Size	Quantity Per Case	Price / Piece ₹
2981005	5	0.1	0.05	10 / 19	5	760.00
2981006	10	0.2	0.10	10 / 19	5	840.00
2981009	25	0.5	0.25	14 / 19	10	960.00
2981012	50	1	0.50	14 / 23	10	1090.00
2981016	100	1	0.50	19 / 26	10	1275.00
2981021	250	2	1	24 / 29	5	2005.00
2981024	500	5	2.5	24 / 29	5	2575.00
2981029	1000	10	5	34 / 35	4	3150.00
2981030	2000	20	10	34 / 35	4	5010.00



2983 - CYLINDERS **NEW**

USP, Class A, Hexagonal Base, with I/C Stopper, with Individual Calibration Certificate

- Tolerance complies with ASTM E 1272 and dimension as per ISO 4788
- Supplied with Interchangeable Penny head Stopper
- Graduated, Single Metric Scale
- Each cylinder is engraved with a unique serial number, and comes with a Certificate of Calibration traceable to national standards
- Graduations in amber enamel
- Sturdy hexagonal base prevents roll-over and ensures greater stability
- Calibrated and certified at 20°C

Product Code	Capacity ml	Graduation Interval ml	Tolerance \pm ml	Stopper Size	Quantity Per Case	Price / Piece ₹
2983005	5	0.1	0.05	10 / 19	5	790.00
2983006	10	0.2	0.10	10 / 19	5	915.00
2983009	25	0.5	0.17	14 / 19	10	1030.00
2983012	50	1	0.25	14 / 23	10	1225.00
2983016	100	1	0.50	19 / 26	10	1370.00
2983021	250	2	1	24 / 29	5	2205.00
2983024	500	5	2	24 / 29	5	2625.00
2983029	1000	10	3	34 / 35	4	3240.00
2983030	2000	20	6	34 / 35	4	6070.00

2982 - CYLINDERS

Class B, Hexagonal Base, with I/C Stopper

- Complies with IS 878, ISO 4788
- Supplied with Interchangeable Penny head Stopper
- Graduated, Single Metric Scale
- Graduations in amber enamel
- Sturdy hexagonal base prevents roll-over and ensures greater stability
- Calibrated at 27°C



Product Code	Capacity ml	Graduation Interval ml	Tolerance \pm ml	Stopper Size	Quantity Per Case	Price / Piece ₹
2982005	5	0.1	0.1	10 / 19	5	405.00
2982006	10	0.2	0.2	10 / 19	5	430.00
2982009	25	0.5	0.5	14 / 19	10	480.00
2982012	50	1	1	14 / 23	10	540.00
2982016	100	1	1	19 / 26	10	665.00
2982021	250	2	2	24 / 29	10	1125.00
2982024	500	5	5	24 / 29	5	1560.00
2982029	1000	10	10	34 / 35	4	2250.00
2982030	2000	20	20	34 / 35	4	3895.00

3021 - CYLINDERS

Class A, Hexagonal base, Pour out, with Individual Calibration Certificate

- Complies with IS 878, ISO 4788
- Graduated, Single Metric Scale
- Each cylinder is engraved with a unique serial number, and comes with a Certificate of Calibration traceable to national standards
- Graduations in amber enamel
- Sturdy hexagonal base prevents roll-over and ensures greater stability
- Calibrated and certified at 27°C



Product Code	Capacity ml	Graduation Interval ml	Tolerance \pm ml	Quantity Per Case	Price / Piece ₹
3021005	5	0.1	0.05	5	460.00
3021006	10	0.2	0.1	5	525.00
3021008	20*	1	0.25	10	670.00
3021009	25	0.5	0.25	10	605.00
3021012	50	1	0.5	10	730.00
3021016	100	1	0.5	10	830.00
3021018	150*	2	1	5	1100.00
3021021	250	2	1	10	1220.00
3021024	500	5	2.5	5	1705.00
3021029	1000	10	5	4	2080.00
3021030	2000	20	10	4	4045.00

* As per Borosil standards.

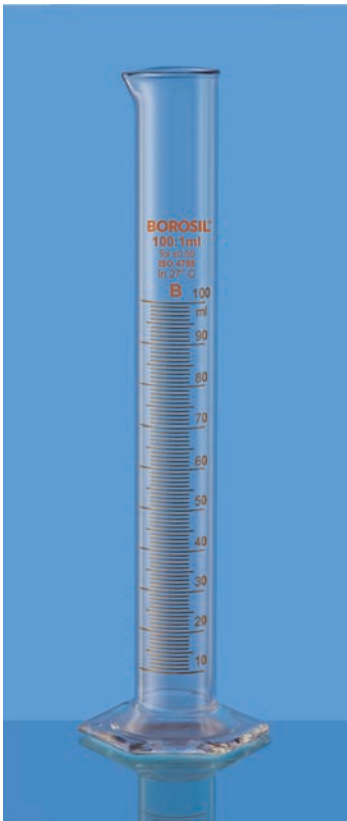

3022 - CYLINDERS

Class B, Hexagonal base, Pour out

- Complies with IS 878, ISO 4788
- Graduated, Single Metric Scale
- Certificate of Calibration traceable to national standards
- Graduations in amber enamel
- Sturdy hexagonal base prevents roll-over and ensures greater stability
- Calibrated at 27°C

Product Code	Capacity ml	Graduation Interval ml	Tolerance \pm ml	Quantity Per Case	Price / Piece ₹
3022005	5	0.1	0.1	5	250.00
3022006	10	0.2	0.2	5	300.00
3022009	25	0.5	0.5	10	350.00
3022012	50	1	1	20	380.00
3022016	100	1	1	20	430.00
3022018	150*	2	2	5	595.00
3022021	250	2	2	10	795.00
3022024	500	5	5	5	1040.00
3022029	1000	10	10	4	1575.00
3022030	2000	20	20	4	3020.00

*150 ml Not covered in any standards.



3026 - CYLINDERS

ASTM, Class A, Hexagonal base, Pour out, with Individual Calibration Certificate

- Complies with ASTM E 1272
- Graduated, Single Metric Scale
- Calibrated as per Class A tolerances required by the United States
- Each cylinder is engraved with a unique serial number, and comes with a Certificate of Calibration traceable to national standards
- Graduations in amber enamel
- Sturdy hexagonal base prevents roll-over and ensures greater stability
- Calibrated and certified at 20°C

Product Code	Capacity ml	Graduation Interval ml	Tolerance \pm ml	Quantity Per Case	Price / Piece ₹
3026005	5	0.1	0.05	5	545.00
3026006	10	0.2	0.10	5	630.00
3026009	25	0.5	0.17	5	710.00
3026012	50	1	0.25	5	845.00
3026016	100	1	0.50	5	945.00
3026021	250	2	1	5	1375.00
3026024	500	5	2	4	1810.00
3026029	1000	10	3	4	2235.00
3026030	2000	20	6	4	4185.00

3027 - CYLINDERS

ASTM, Class B, Hexagonal base, Pour out

- Complies with ASTM E 1272
- Graduated, Single Metric Scale
- Calibrated as per Class B tolerances required by the United States
- Each cylinder is engraved with a unique serial number, and comes with a Certificate of Calibration traceable to national standards
- Graduations in amber enamel
- Sturdy hexagonal base prevents roll-over and ensures greater stability
- Calibrated at 20°C

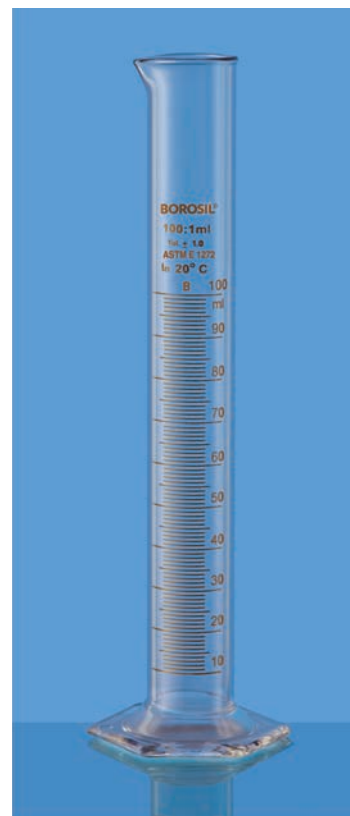

Till stock lasts					
Product Code	Capacity ml	Graduation Interval ml	Tolerance \pm ml	Quantity Per Case	Price / Piece ₹
3027005	5	0.1	0.1	5	320.00
3027006	10	0.2	0.2	5	360.00
3027009	25	0.5	0.34	10	430.00
3027012	50	1	0.5	10	480.00
3027016	100	1	1	10	525.00
3027021	250	2	2	10	920.00
3027024	500	5	4	5	1145.00
3027029	1000	10	6	4	1700.00
3027030	2000	20	12	4	3140.00

3032 - TAPPED DENSITY CYLINDER

- As Per USP, Ch. 616
- Supplied as a set of two cylinders
- Used in tapped density apparatus to measure bulk density of powders
- Graduation in amber enamel
- Sturdy hexagonal base prevents roll-over and ensures greater stability
- Calibrated at 20°C

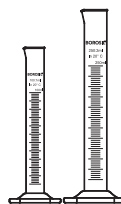

Product Code	Capacity ml	Quantity Per Case Set	Price / Set ₹
3032041	100 & 250	1 Each	2555.00

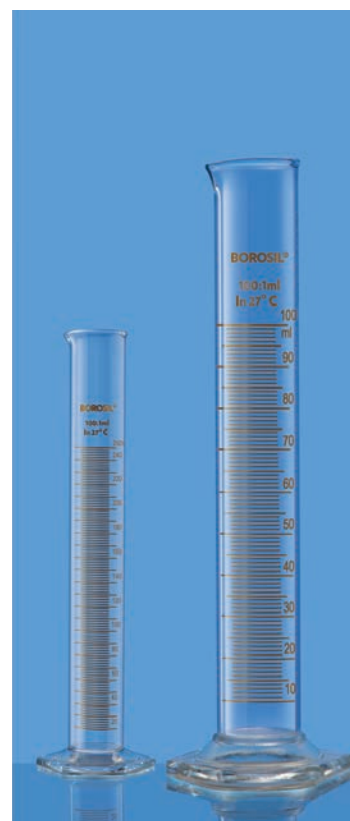

3033 - TAPPED DENSITY CYLINDER

- As Per USP, Ch. 616

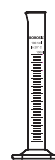

Product Code	Capacity ml	Quantity Per Case Set	Price / Set ₹
3033016	100	2	1330.00

3034 - TAPPED DENSITY CYLINDER

- As Per USP, Ch. 616



Product Code	Capacity ml	Quantity Per Case Set	Price / Set ₹
3034021	250	2	1530.00

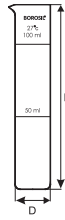

2975 - NESSLER CYLINDERS

- Complies with IS 4161
- Facilitates colour comparison of water samples, freedom from colour or visible defects
- White enamel inscriptions
- Calibrated at 27°C

Product Code	Capacity ml	Approx O.D. x Height	Tolerance \pm ml	Quantity Per Case mm	Price / Piece ₹
2975012	50	25 x 150	0.40	20	185.00
2975016	100	34 x 180	0.80	30	270.00

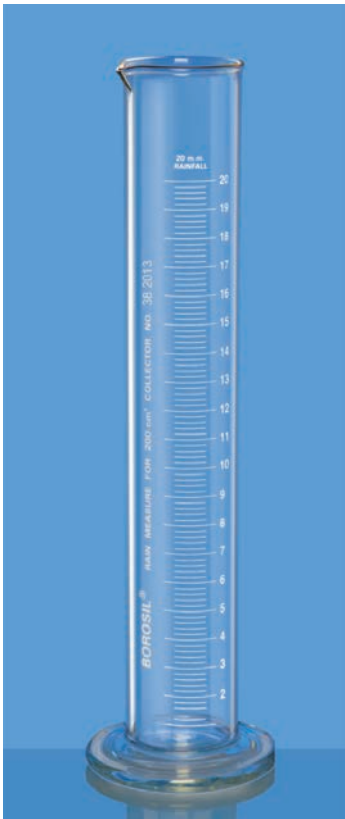

3070 - RAIN MEASURE CYLINDERS

Round base

- Complies with IS 4849
- Graduated, Single metric scale
- Graduation in white enamel
- The cylinders are graduated to indicate rainfall in mm when used with appropriate rain collector
- Calibrated at 27°C

Product Code	Size mm	Used For Collector Area cm ²	Graduation Interval mm	Tolerance \pm ml	Quantity Per Case	Price / Piece ₹
3070096	20	200	0.2	0.05	5	1350.00
3070098	20	100	0.2	0.10	10	1580.00

BOROSIL®

Laser Marked Volumetric Glassware

- Improved visibility and legibility
- Easy identification and quick tracing of code
- Errors involved in manual etching are avoided
- Excellent print quality
- Easy retrieval of data

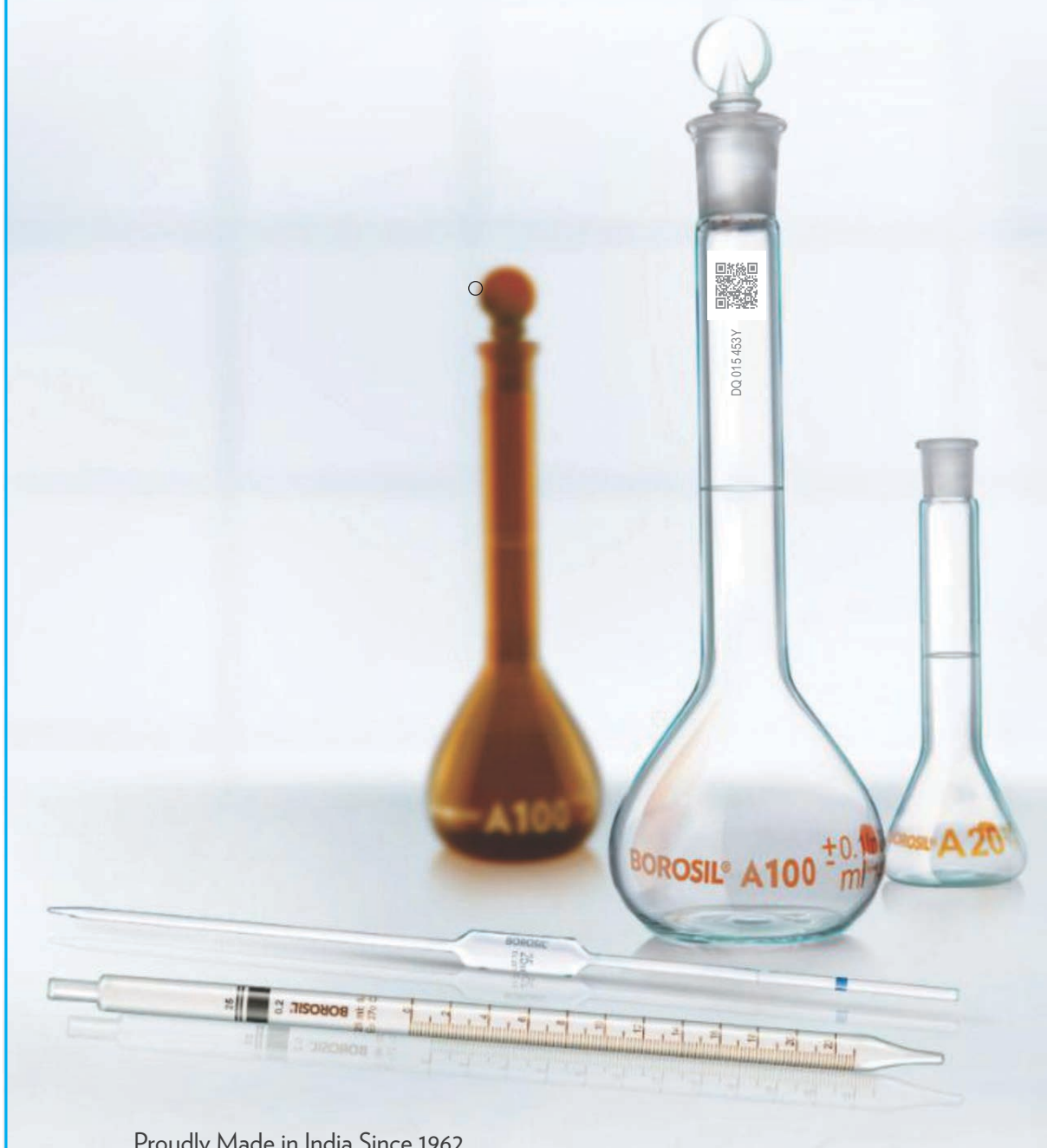

Proudly Made in India Since 1962

Burettes



Accuracy, reliability and durability are the three essentials of burettes offered by **BOROSIL®**

Burettes are made from heavy walled, machine drawn borosilicate glass tubing, of precise bore sizes, to provide highest level of accuracy even after repeated usage.

- Complies with highest quality standards according to IS 1997 and ISO 385
- Individually calibrated on automatic calibration machines
- Available in both Class A and Class B tolerances
- Individual calibration certificate provided for Class A Burettes
- Graduation markings made using finest quality white enamel or amber ink to ensure maximum durability
- Stringent control throughout the process of manufacturing and quality checks minimizes the possibility of deviations

Made from 3.3 Low Expansion Borosilicate Glass

USP
TYPE I

TYPE I
ASTM
E438
CLASS A

ISO
3585

BOROSIL Burettes are fitted with Boroflo GP (General Purpose) stopcocks with PTFE keys that offers the following operational advantages :

- No lubrication required as PTFE key is used, hence no chances of contamination with grease
- Excellent flow control
- All glass/PTFE pathway which is highly resistant to chemical attack
- The unique Fluon/glass seal ensures no leakage
- No springs or retaining devices required
- Easy to dismantle and clean
- Absence of ground surfaces resulting in low absorption of radioactivity
- Consistent performance between 0°C to 50°C

In addition to Boroflo GP stopcock, **BOROSIL** also offers burettes with straight bore glass stopcocks and straight bore PTFE stopcocks



Burette with Boroflo GP stopcock



Burette with PTFE stopcock



Burette with Glass stopcock

- Boroflo stopcocks have PTFE keys which do not require greasing
- The PTFE keys provide best drop control during titration process
- Due to identical shape of PTFE key the Burette valve can be closed with gentle turn.
- PTFE stopcocks have identical keys, hence there is no need to match pairs after cleaning
- PTFE is self lubricating hence the keys do not require greasing
- Specially designed solid glass stopcocks are manufactured from 3.3 Low expansion borosilicate glass
- Glass stopcocks are perfectly ground , for leak free operations



2121 - BURETTES

With Boroflo stopcock, Class A, with Individual Calibration Certificate

- Complies with IS 1997 / ISO 385, Accuracy as per class A
- Supplied with Boroflo stopcock
- No lubrication required
- Calibrated & certified at 27°C and supplied with certificate of calibration traceable to National standards
- Generally used in titration process

Product Code	Capacity ml	Graduation Interval ml	Tolerance \pm ml	Quantity Per Case	Price / Piece ₹
2121006	10	0.05	0.03	5	1865.00
2121U06*	10	0.05	0.02	5	1935.00
2121009	25	0.10	0.05	5	1920.00
2121U09*	25	0.10	0.03	5	2060.00
2121012	50	0.10	0.05	5	2185.00
2121016	100	0.20	0.10	5	3070.00

* Accuracy as per ASTM E287-2 and calibrated at 20°C
50 ml and 100 ml capacities complies both standards - ISO and ASTM for accuracy

2122 - BURETTES

With Boroflo stopcock, Class B

- Complies with IS 1997 / ISO 385, Accuracy as per class B
- Supplied with Boroflo stopcock
- No lubrication required
- Calibrated at 27°C
- Generally used in titration process

Product Code	Capacity ml	Graduation Interval ml	Tolerance \pm ml	Quantity Per Case	Price / Piece ₹
2122006	10	0.05	0.05	10	630.00
2122009	25	0.10	0.10	10	595.00
2122012	50	0.10	0.10	5	640.00
2122016	100	0.20	0.20	5	960.00

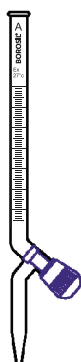

2131 - BURETTES

With Boroflo stopcock, Class A, Amber, with Individual Calibration Certificate

- Complies with IS 1997 / ISO 385, Accuracy as per class A
- Supplied with Boroflo stopcock
- No lubrication required
- Calibrated & certified at 27°C and supplied with certificate of calibration traceable to National standards
- Amber coating on exterior surfaces to facilitate use with light sensitive solutions
- Generally used in titration process

Product Code	Capacity ml	Graduation Interval ml	Tolerance \pm ml	Quantity Per Case	Price / Piece ₹
2131009	25	0.10	0.05	5	3170.00
2131012	50	0.10	0.05	5	3515.00

2132 - BURETTES

With Boroflo stopcock, Class B, Amber

- Complies with IS 1997 / ISO 385, Accuracy as per class B
- Supplied with Boroflo stopcock
- No lubrication required
- Calibrated at 27°C
- Amber coating on exterior surfaces to facilitate use with light sensitive solutions
- Generally used in titration process

Product Code	Capacity ml	Graduation Interval ml	Tolerance \pm ml	Quantity Per Case	Price / Piece ₹
2132009	25	0.10	0.10	10	965.00
2132012	50	0.10	0.10	5	1060.00

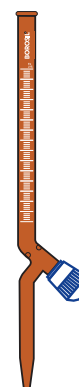



2123 - BURETTES

With Glass stopcock, Class A, with Individual Calibration Certificate

- Complies with IS 1997 / ISO 385, Accuracy as per class A
- Designed with straight bore stopcock that increases the life, compared to Boroflo stopcocks
- The glass stopcock enhances control and enables smoother action
- Calibrated & certified at 27°C and supplied with certificate of calibration traceable to National standards
- Generally used in Titration process

Product Code	Capacity ml	Graduation Interval ml	Tolerance \pm ml	Quantity Per Case	Price / Piece ₹
2123005	5	0.02	0.01	5	2000.00
2123006	10	0.05	0.03	5	2110.00
2123009	25	0.10	0.05	5	2070.00
2123012	50	0.10	0.05	5	2350.00
2123016	100	0.20	0.10	5	3390.00

2124 - BURETTES

With Glass stopcock, Class B

- Complies with IS 1997 / ISO 385, Accuracy as per class B
- Designed with straight bore stopcock that increases the life, compared to Boroflo stopcocks
- The glass stopcock enhances control and enables smoother action
- Calibrated at 27°C
- Generally used in Titration process

Product Code	Capacity ml	Graduation Interval ml	Tolerance \pm ml	Quantity Per Case	Price / Piece ₹
2124005	5	0.02	0.02	5	845.00
2124006	10	0.05	0.05	10	720.00
2124009	25	0.10	0.10	10	700.00
2124012	50	0.10	0.10	5	750.00
2124016	100	0.20	0.20	5	1065.00

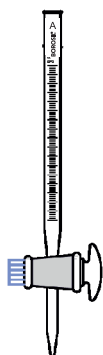

2129 - BURETTES

With PTFE stopcock, Class A, with Individual Calibration Certificate

- Complies with IS 1997 / ISO 385, Accuracy as per class A
- Supplied with PTFE stopcock that is highly resistant to chemical attack
- No lubrication required
- Calibrated & certified at 27°C and supplied with certificate of calibration traceable to National standards
- Generally used in Titration process

Product Code	Capacity ml	Graduation Interval ml	Tolerance \pm ml	Quantity Per Case	Price / Piece ₹
2129012	50	0.1	0.05	5	2350.00

Burettes of other capacities are on request

2130 - BURETTES

With PTFE stopcock, Class B

- Complies with IS 1997 / ISO 385, Accuracy as per class B
- Supplied with PTFE stopcock that is highly resistant to chemical attack
- No lubrication required
- Calibrated at 27°C
- Generally used in Titration process

Product Code	Capacity ml	Graduation Interval ml	Tolerance \pm ml	Quantity Per Case	Price / Piece ₹
2130012	50	0.1	0.1	5	915.00

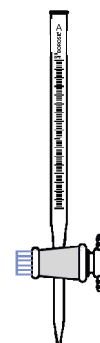

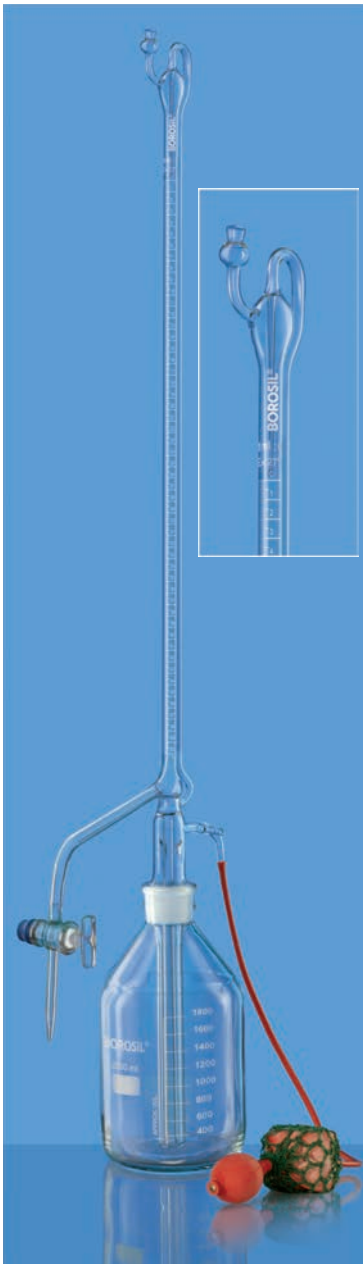

2149 - AUTOBURETTES

With Glass stopcock, Class A, with Individual Calibration Certificate

- Complies with IS 1997 / ISO 385, Accuracy as per class A
- Supplied with Reservoir and Rubber Bellow
- With automatic zero facility
- Calibrated & certified at 27°C and supplied with certificate of calibration traceable to National standards
- Generally used in Titration process

Product Code	Capacity ml	Graduation Interval ml	Tolerance \pm ml	Quantity Per Case	Price / Piece ₹
2149006	10	0.05	0.03	1	7820.00
2149009	25	0.10	0.05	1	7570.00
2149012	50	0.10	0.05	1	8470.00
2149016	100	0.20	0.10	1	9640.00

Reservoir Capacity : 500 ml for 10 ml size and 2000 ml for 25, 50 and 100 ml sizes.

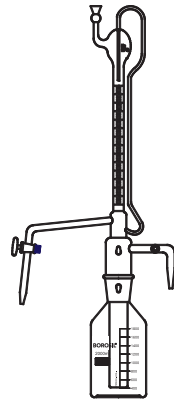

2150 - AUTOBURETTES

With Glass stopcock, Class B

- Complies with IS 1997 / ISO 385, Accuracy as per class B
- Supplied with Reservoir and Rubber Bellow
- With automatic zero facility
- Calibrated at 27°C
- Generally used in Titration process

Product Code	Capacity ml	Graduation Interval ml	Tolerance \pm ml	Quantity Per Case	Price / Piece ₹
2150006	10	0.05	0.05	1	5020.00
2150009	25	0.10	0.10	1	4940.00
2150012	50	0.10	0.10	1	5355.00
2150016	100	0.20	0.20	1	6100.00

Reservoir Capacity : 500 ml for 10 ml size and 2000 ml for 25, 50 and 100 ml sizes.

2149A - AUTOBURETTES

With Glass stopcock, Class A, Amber, with Individual Calibration Certificate

- Complies with IS 1997 / ISO 385, Accuracy as per class A
- Supplied with Reservoir and Rubber Bellow
- With automatic zero facility
- Calibrated & certified at 27°C and supplied with certificate of calibration traceable to National standards
- Amber coating on exterior surfaces to facilitate use with light sensitive solutions
- Generally used in Titration process

Product Code	Capacity ml	Graduation Interval ml	Tolerance \pm ml	Quantity Per Case	Price / Piece ₹
2149A06	10	0.05	0.03	1	16820.00
2149A09	25	0.10	0.05	1	17825.00
2149A12	50	0.10	0.05	1	19620.00
2149A16	100	0.20	0.10	1	20270.00

Reservoir Capacity : 500 ml for 10 ml size and 2000 ml for 25, 50 and 100 ml sizes.

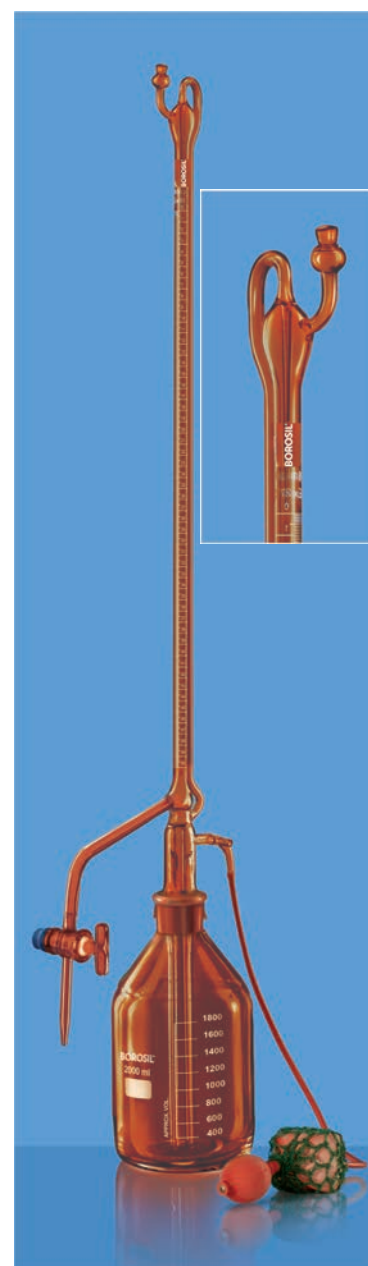
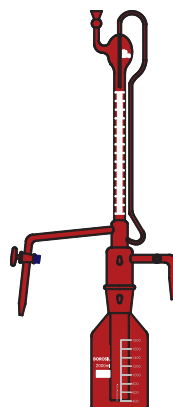

2150A - AUTOBURETTES

With Glass stopcock, Class B, Amber

- Complies with IS 1997 / ISO 385, Accuracy as per class B
- Supplied with Reservoir and Rubber Bellow
- With automatic zero facility
- Calibrated at 27°C
- Amber coating on exterior surfaces to facilitate use with light sensitive solutions
- Generally used in Titration process

Product Code	Capacity ml	Graduation Interval ml	Tolerance \pm ml	Quantity Per Case	Price / Piece ₹
2150A06	10	0.05	0.05	1	11725.00
2150A09	25	0.10	0.10	1	11900.00
2150A12	50	0.10	0.10	1	12140.00
2150A16	100	0.20	0.20	1	12730.00

Reservoir Capacity : 500 ml for 10 ml size and 2000 ml for 25, 50 and 100 ml sizes.



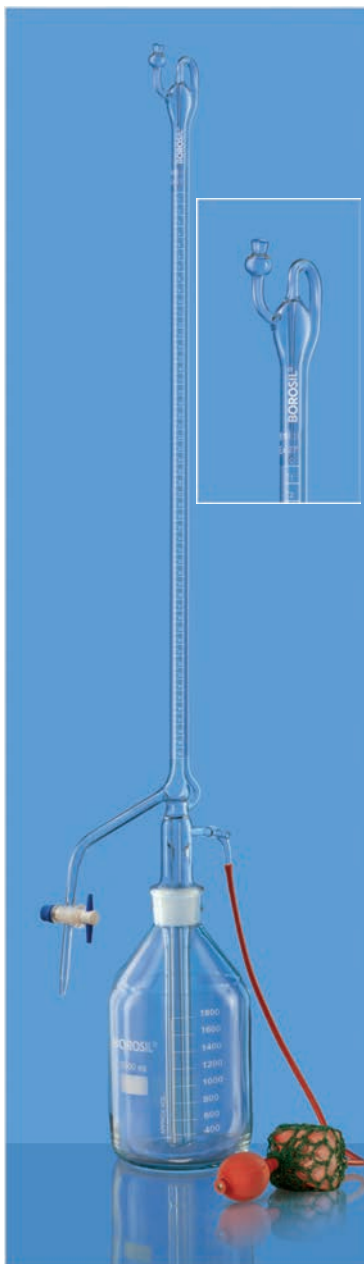

2153 - AUTOBURETTES

With PTFE Stopcock, Class A, with Individual Calibration Certificate

- Complies with IS 1997 / ISO 385, Accuracy as per class A
- Supplied with PTFE stopcock that is highly resistant to chemical attack
- Supplied with Reservoir and Rubber Bellow
- With automatic zero facility
- Calibrated & certified at 27°C and supplied with certificate of calibration traceable to National standards
- Generally used in titration process

Product Code	Capacity ml	Graduation Interval ml	Tolerance \pm ml	Quantity Per Case	Price / Piece ₹
2153006	10	0.05	0.03	1	8250.00
2153009	25	0.10	0.05	1	8065.00
2153012	50	0.10	0.05	1	8945.00
2153016	100	0.20	0.10	1	10220.00

Reservoir Capacity : 500 ml for 10 ml size and 2000 ml for 25, 50 and 100 ml sizes.

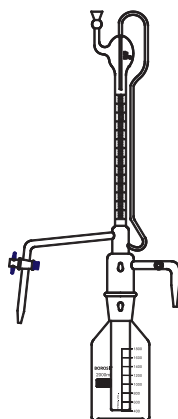

2154 - AUTOBURETTES

With PTFE stopcock, Class B

- Complies with IS 1997 / ISO 385, Accuracy as per class B
- Supplied with PTFE stopcock that is highly resistant to chemical attack
- Supplied with Reservoir and Rubber Bellow
- With automatic zero facility
- Calibrated at 27°C
- Generally used in titration process

Product Code	Capacity ml	Graduation Interval ml	Tolerance \pm ml	Quantity Per Case	Price / Piece ₹
2154006	10	0.05	0.05	1	5300.00
2154009	25	0.10	0.10	1	5190.00
2154012	50	0.10	0.10	1	5635.00
2154016	100	0.20	0.20	1	6400.00

Reservoir Capacity : 500 ml for 10 ml size and 2000 ml for 25, 50 and 100 ml sizes.

2153A - AUTOBURETTES

With PTFE stopcock, Class A, Amber, with Individual Calibration Certificate

- Complies with IS 1997 / ISO 385, Accuracy as per class A
- Supplied with PTFE stopcock that is highly resistant to chemical attack
- Supplied with Reservoir and Rubber Bellow
- With automatic zero facility
- Calibrated & certified at 27°C and supplied with certificate of calibration traceable to National standards
- Amber coating on exterior surfaces to facilitate use with light sensitive solutions
- Generally used in titration process

Product Code	Capacity ml	Graduation Interval ml	Tolerance \pm ml	Quantity Per Case	Price / Piece ₹
2153A06	10	0.05	0.03	1	17440.00
2153A09	25	0.10	0.05	1	18620.00
2153A12	50	0.10	0.05	1	20385.00
2153A16	100	0.20	0.10	1	21330.00

Reservoir Capacity : 500 ml for 10 ml size and 2000 ml for 25, 50 and 100 ml sizes.

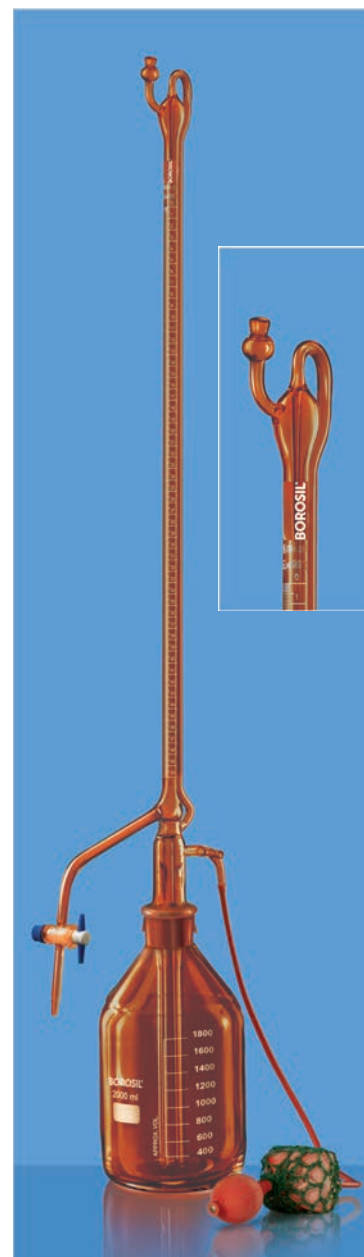
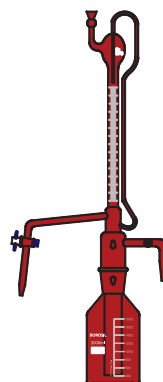

2154A - AUTOBURETTES

With PTFE stopcock, Class B, Amber

- Complies with IS 1997 / ISO 385, Accuracy as per class B
- Supplied with PTFE stopcock that is highly resistant to chemical attack
- Supplied with Reservoir and Rubber Bellow
- With automatic zero facility
- Calibrated at 27°C
- Amber coating on exterior surfaces to facilitate use with light sensitive solutions
- Generally used in titration process

Product Code	Capacity ml	Graduation Interval ml	Tolerance \pm ml	Quantity Per Case	Price / Piece ₹
2154A06	10	0.05	0.05	1	11900.00
2154A09	25	0.10	0.10	1	11195.00
2154A12	50	0.10	0.10	1	11490.00
2154A16	100	0.20	0.20	1	12020.00

Reservoir Capacity : 500 ml for 10 ml size and 2000 ml for 25, 50 and 100 ml sizes.





2155 - AUTOBURETTES

With Boroflo stopcock, Class A, with Individual Calibration Certificate

- Complies with IS 1997 / ISO 385, Accuracy as per class A
- Supplied with Boroflo stopcock, Reservoir and Rubber Bellow
- With automatic zero facility
- Calibrated & certified at 27°C and supplied with certificate of calibration traceable to National standards
- Generally used in titration process

Product Code	Capacity ml	Graduation Interval ml	Tolerance \pm ml	Quantity Per Case	Price / Piece ₹
2155006	10	0.05	0.03	1	7555.00
2155009	25	0.10	0.05	1	7360.00
2155012	50	0.10	0.05	1	8175.00
2155016	100	0.20	0.10	1	9290.00

Reservoir Capacity : 500 ml for 10 ml size and 2000 ml for 25, 50 and 100 ml sizes.

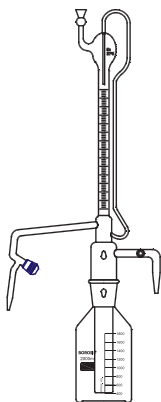

2156 - AUTOBURETTES

With Boroflo stopcock, Class B

- Complies with IS 1997 / ISO 385, Accuracy as per class B
- Supplied with Boroflo stopcock, Reservoir and Rubber Bellow
- With automatic zero facility
- Calibrated at 27°C
- Generally used in titration process

Product Code	Capacity ml	Graduation Interval ml	Tolerance \pm ml	Quantity Per Case	Price / Piece ₹
2156006	10	0.05	0.05	1	4890.00
2156009	25	0.10	0.10	1	4775.00
2156012	50	0.10	0.10	1	5230.00
2156016	100	0.20	0.20	1	6005.00

Reservoir Capacity : 500 ml for 10 ml size and 2000 ml for 25, 50 and 100 ml sizes.

2155A - AUTOBURETTES

With Boroflo stopcock, Class A, Amber, with Individual Calibration Certificate

- Complies with IS 1997 / ISO 385, Accuracy as per class A
- Supplied with Boroflo stopcock, Reservoir and Rubber Bellow
- With automatic zero facility
- Amber coating on exterior surfaces to facilitate use with light sensitive solutions
- Calibrated & certified at 27°C and supplied with certificate of calibration traceable to National standards
- Generally used in titration process

Product Code	Capacity ml	Graduation Interval ml	Tolerance \pm ml	Quantity Per Case	Price / Piece ₹
2155A06	10	0.05	0.03	1	16620.00
2155A09	25	0.10	0.05	1	17560.00
2155A12	50	0.10	0.05	1	19505.00
2155A16	100	0.20	0.10	1	20150.00

Reservoir Capacity : 500 ml for 10 ml size and 2000 ml for 25, 50 and 100 ml sizes.

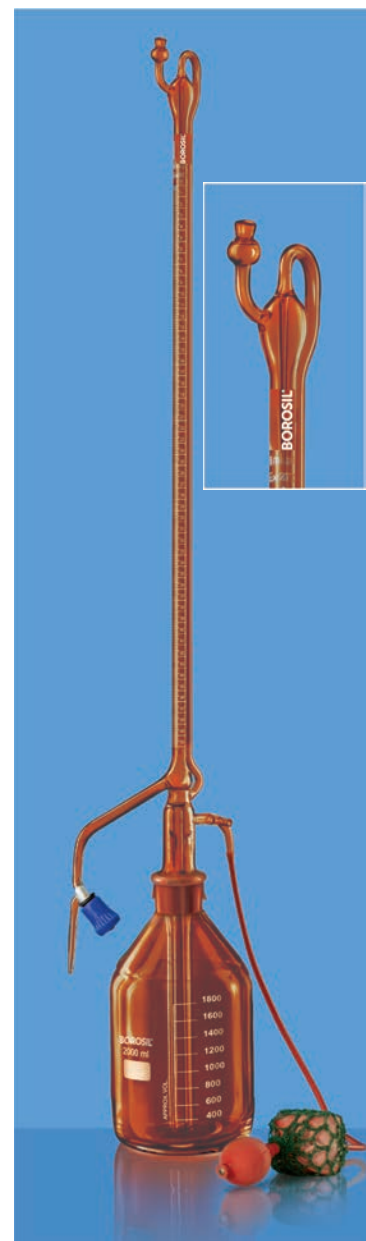
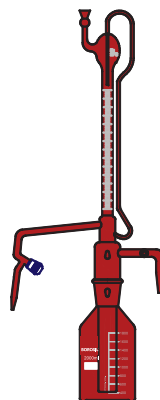

2156A - AUTOBURETTES

With Boroflo stopcock, Class B, Amber

- Complies with IS 1997 / ISO 385, Accuracy as per class B
- Supplied with Boroflo stopcock, Reservoir and Rubber Bellow
- With automatic zero facility
- Calibrated at 27°C
- Amber coating on exterior surfaces to facilitate use with light sensitive solutions
- Generally used in titration process

Product Code	Capacity ml	Graduation Interval ml	Tolerance \pm ml	Quantity Per Case	Price / Piece ₹
2156A06	10	0.05	0.05	1	11610.00
2156A09	25	0.10	0.10	1	11725.00
2156A12	50	0.10	0.10	1	12080.00
2156A16	100	0.20	0.20	1	12550.00

Reservoir Capacity : 500 ml for 10 ml size and 2000 ml for 25, 50 and 100 ml sizes.



NABL Certified Glassware

Made from 3.3 Low Expansion
Borosilicate Glass



NABL Accredited Testing Laboratory

Operated by trained and certified lab technicians



BOROSIL offers a range of glassware certified as per NABL norms

Volumetric Flasks

Measuring Cylinders

Burettes

Volumetric & Graduated
Pipettes

NABL Accreditation
Certificate



NABL Product
Certificate



Product details

Calibration details

Calibration Equipment
traceability

Statement for recalibration



2020 - VOLUMETRIC FLASKS

NABL Certified, Class A, Clear, with Individual Calibration Certificate

- Complies with IS 915 / ISO 1042, Accuracy as per class A
- Supplied with Interchangeable Glass Stopper
- Each flask is marked with individual serial number and supplied with certificate of calibration traceable to National standards
- Amber enamel inscriptions
- Calibrated & certified at 27°C

Product Code	Capacity ml	Tolerance ± ml	New Stopper Size	New Quantity Per Case	Price / Piece ₹
2020001	1	0.025	7 / 16	1	2055.00
2020002	2	0.025	7 / 16	1	2055.00
2020005	5	0.025	10 / 19 #	1	1830.00
2020006	10	0.025	10 / 19 #	1	1585.00
2020008	20	0.04	10 / 19	1	1585.00
2020009	25	0.04	10 / 19	1	1475.00
2020012	50	0.06	12 / 21	1	1475.00
2020016	100	0.10	14 / 23	1	1450.00
2020020	200	0.15	14 / 23	1	1935.00
2020021	250	0.15	14 / 23	1	1955.00
2020024	500	0.25	19 / 26	1	2610.00
2020029	1000	0.40	24 / 29	1	3750.00
2020030	2000	0.60	29 / 32	1	6070.00

- 1 ml to 20 ml supplied with trapezoidal shape for better stability
- Certified and Calibrated at 27°C
- Volumetric flasks with old stopper sizes - Available till stocks last
- # Stopper size as per Borosil Design

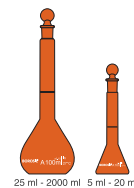

2021 - VOLUMETRIC FLASKS

NABL Certified, Class A, Amber, with Individual Calibration Certificate

- Complies with IS 915 / ISO 1042, Accuracy as per class A
- Supplied with Interchangeable Glass Stopper
- Each flask is marked with individual serial number and supplied with certificate of calibration traceable to National standards
- White enamel inscriptions
- Calibrated & certified at 27°C

Product Code	Capacity ml	Tolerance ± ml	New Stopper Size	Quantity Per Case	Price / Piece ₹
2021005	5	0.025	10 / 19*	1	1985.00
2021006	10	0.025	10 / 19*	1	1735.00
2021008	20	0.04	10 / 19*	1	1735.00
2021009	25	0.04	10 / 19	1	1570.00
2021012	50	0.06	12 / 21	1	1540.00
2021016	100	0.10	14 / 23	1	1590.00
2021020	200	0.15	14 / 23	1	2075.00
2021021	250	0.15	14 / 23	1	2105.00
2021024	500	0.25	19 / 26	1	2880.00
2021029	1000	0.40	24 / 29	1	4250.00
2021030	2000	0.60	29 / 32	1	6680.00

- 5 ml to 20 ml supplied with trapezoidal shape for better stability
- # Stopper size as per Borosil Design

2040 - VOLUMETRIC PIPETTES

NABL Certified, Class A, with Individual Calibration Certificate

- Complies with IS 1117, ISO 648
- Calibrated for delivery (TD, Ex)
- Each pipette coded with unique identification number (UID) and supplied with NABL calibration certificate with traceability to national standards
- Generally used for accurate measurement and decanting of liquid
- Calibrated and certified at 27°C



Product Code	Capacity ml	Tolerance ± ml	Quantity Per Case	Price / Piece ₹
2040001	1	0.008	1	620.00
2040002	2	0.01	1	635.00
2040005	5	0.015	1	685.00
2040006	10	0.02	1	840.00
2040008	20	0.03	1	1090.00
2040009	25	0.03	1	1170.00
2040012	50	0.05	1	1310.00
2040016	100	0.08	1	1985.00

2030 - MOHR PIPETTES

NABL Certified, Class A

- Complies with IS, ISO 835, Type I
- Graduated for delivery from zero mark to the last graduation mark
- Supplied with individual NABL calibration certificate showing actual volume dispensed and providing traceability to national standards
- Markings are made in permanent amber stain diffused into the surface of the glass for better visibility and durability
- Calibrated & certified at 27°C

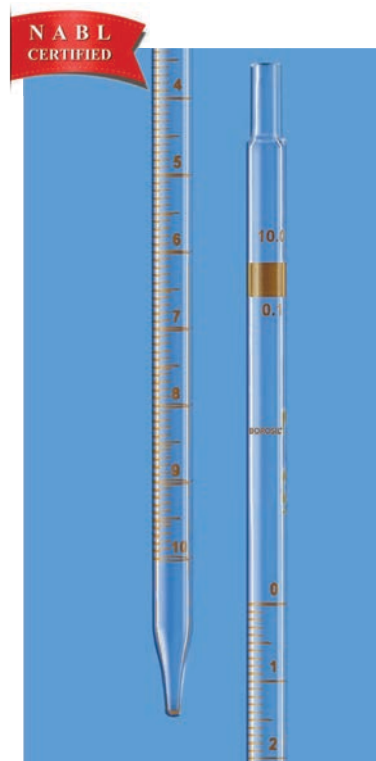

Product Code	Capacity ml	Graduation Interval ml	Tolerance ± ml	Quantity Per Case	Price / Piece ₹
2030P41	0.1	0.01	0.006	1	940.00
2030P42	0.2	0.01	0.006	1	940.00
2030P01	1	0.01	0.007	1	915.00
2030P11	1	0.10	0.007	1	765.00
2030P02	2	0.02	0.01	1	955.00
2030P22	2	0.10	0.01	1	800.00
2030P05	5	0.05	0.03	1	1020.00
2030P55	5	0.10	0.03	1	940.00
2030P06	10	0.10	0.05	1	1075.00
2030P09	25	0.20	0.10	1	1250.00



2010 - CYLINDERS

NABL Certified, Class A, Hexagonal base, Pour out, with Individual Calibration Certificate

- Complies with IS 1997, ISO 4788
- Graduated, Single Metric Scale
- Calibrated & certified at 27°C and supplied with NABL certificate of calibration traceable to National standards
- Graduations in amber enamel
- Sturdy hexagonal base prevents roll-over and ensures greater stability

Product Code	Capacity ml	Graduation Interval ml	Tolerance ± ml	Quantity Per Case	Price / Piece ₹
2010005	5	0.1	0.05	1	1060.00
2010006	10	0.2	0.10	1	1155.00
2010009	25	0.5	0.25	1	1370.00
2010012	50	1	0.50	1	1620.00
2010016	100	1	0.50	1	1830.00
2010018	150*	2	1	1	2460.00
2010021	250	2	1	1	2775.00
2010024	500	5	2.5	1	3775.00
2010029	1000	10	5	1	4670.00
2010030	2000	20	10	1	8945.00

* 150 ml not covered in standard.

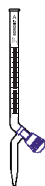

2000 - BURETTES

With Boroflo stopcock, NABL Certified, Class A, with Individual Calibration Certificate

- Complies with IS 1997 / ISO 385, Accuracy as per class A
- Supplied with Boroflo stopcock
- No lubrication required
- Calibrated & certified at 27°C and supplied with NABL certificate of calibration traceable to National standards
- Generally used in titration process

Product Code	Capacity ml	Graduation Interval ml	Tolerance ± ml	Quantity Per Case	Price / Piece ₹
2000006	10	0.05	0.03	1	3805.00
2000009	25	0.10	0.05	1	3940.00
2000012	50	0.10	0.05	1	4450.00
2000016	100	0.20	0.10	1	6250.00

2001 - BURETTES

With Boroflo stopcock, NABL Certified, Class A, Amber, with Individual Calibration Certificate

- Complies with IS 1997 / ISO 385, Accuracy as per class A
- Supplied with Boroflo stopcock
- No lubrication required
- Calibrated & certified at 27°C and supplied with NABL certificate of calibration traceable to National standards
- Amber coating on exterior surfaces to facilitate use with light sensitive solutions
- Generally used in titration process

Product Code	Capacity ml	Graduation Interval ml	Tolerance \pm ml	Quantity Per Case	Price / Piece ₹
2001009	25	0.1	0.05	1	6030.00
2001012	50	0.1	0.05	1	6840.00

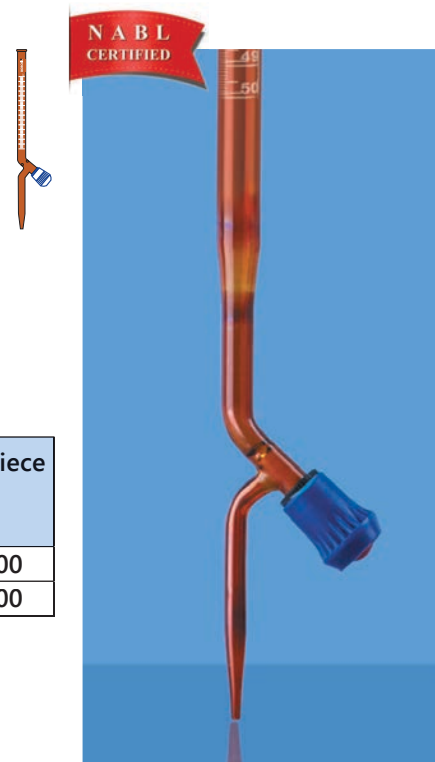

2002 - BURETTES

With Glass stopcock, NABL Certified, Class A, with Individual Calibration Certificate

- Complies with IS 1997 / ISO 385, Accuracy as per class A
- Designed with straight bore stopcock that increases the life, compared to PTFE key stopcocks
- The glass stopcock enhances control and enables smoother action
- Calibrated & certified at 27°C and supplied with NABL certificate of calibration traceable to National standards
- Generally used in titration process

Product Code	Capacity ml	Graduation Interval ml	Tolerance \pm ml	Quantity Per Case	Price / Piece ₹
2002006	10	0.05	0.03	1	3920.00
2002009	25	0.10	0.05	1	4055.00
2002012	50	0.10	0.05	1	4630.00
2002016	100	0.20	0.10	1	6595.00

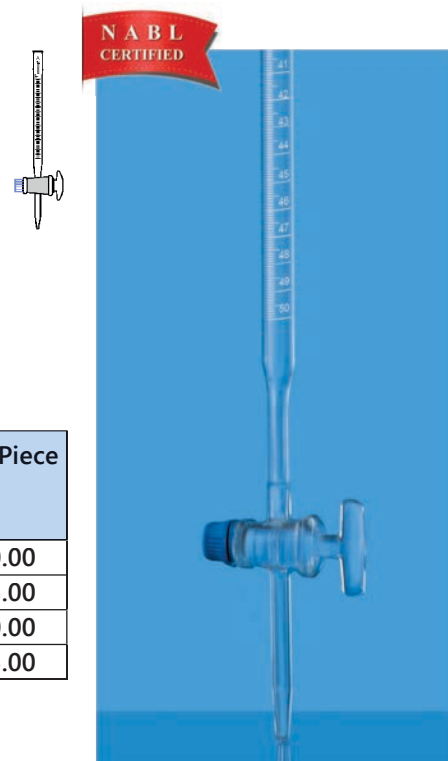

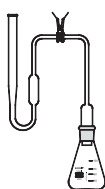

5200 - ARSENIC DETERMINATION APPARATUS AS PER USP

Product Code	Quantity Per Case	Price / Piece ₹
5200001	1	3315.00

Spare parts available on request

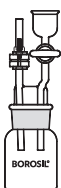

5201 - ARSENIC DETERMINATION APPARATUS GUTZEIT

Product Code	Quantity Per Case	Price / Piece ₹
5201001	1	3315.00

Spare parts available on request



5202 - ARSENIC DETERMINATION APPARATUS AS PER BP

Product Code	Quantity Per Case	Price / Piece ₹
5202001	1	2430.00

Spare parts available on request

5203 - ARSENIC DETERMINATION APPARATUS AS PER IP



Product Code	Quantity Per Case	Price / Piece ₹
5203001	1	2030.00
Spare parts available on request		

5204 - ARSENIC DETERMINATION APPARATUS AS PER IS

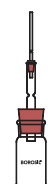

Product Code	Quantity Per Case	Price / Piece ₹
5204001	1	2430.00
Spare parts available on request		

5205 - ARSENIC DETERMINATION APPARATUS **NEW** AS PER JP

Product Code	Quantity Per Case	Price / Piece ₹
5205001	1	2520.00
Spare parts available on request		

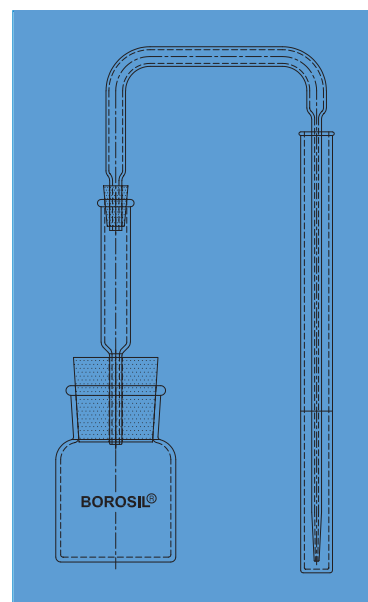

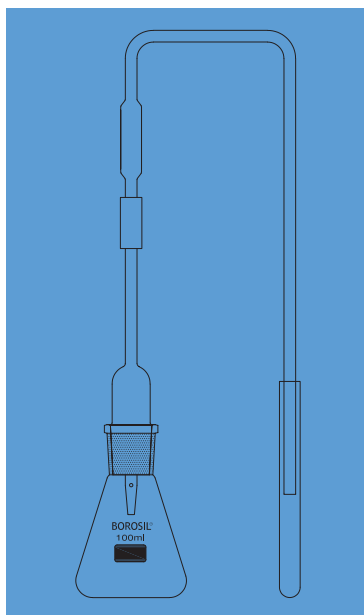

5206 - ARSENIC DETERMINATION APPARATUS **NEW** AS PER EP

Product Code	Quantity Per Case	Price / Piece ₹
5206001	1	2980.00
Spare parts available on request		

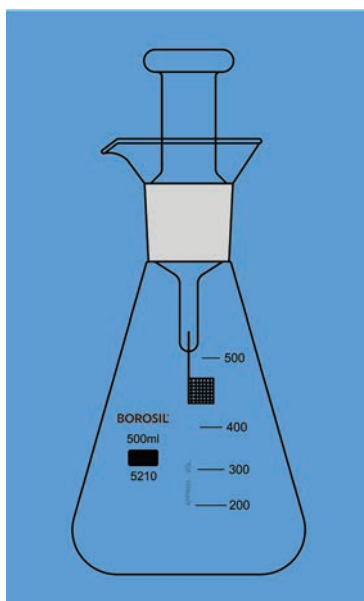

5210 - OXYGEN COMBUSTION FLASK AS PER USP

- Complies to ASTM E205 - 96
- Used for the determination of bromine, chlorine, iodine and sulphur

Product Code	Capacity ml	Quantity Per Case	Price / Piece ₹
5210022	300	1	on request
5210024	500	1	on request
Spare parts available on request			

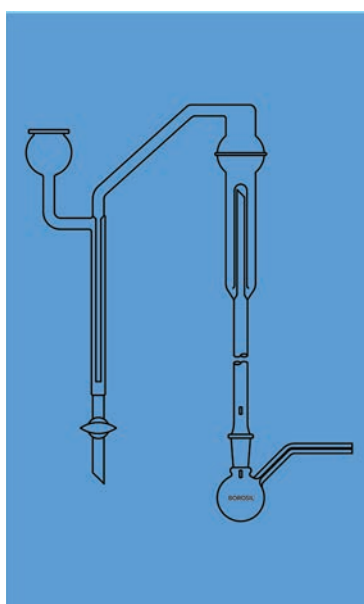

5211 - METHOXY DETERMINATION ASSEMBLY AS PER USP

Product Code	Quantity Per Case	Price / Piece ₹
5211024	1	on request
Spare parts available on request		

5212 - SULPHUR DI-OXIDE ASSEMBLY AS PER USP

Product Code	Quantity Per Case	Price / Piece ₹
5212024	1	13480.00
Spare parts available on request		

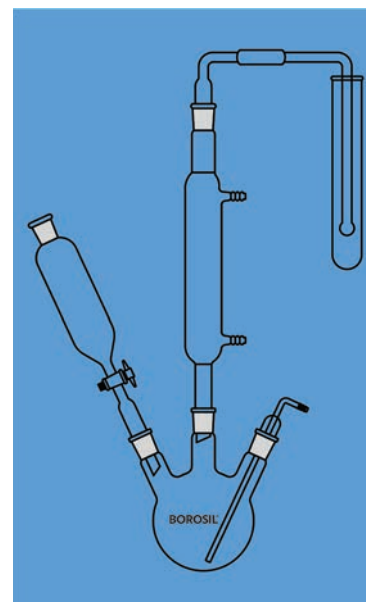
5215 - SODIUM ALGinate ASSEMBLY **NEW** AS PER USP

Product Code	Quantity Per Case	Price / Piece ₹
5215021	1	on request
Spare parts available on request		

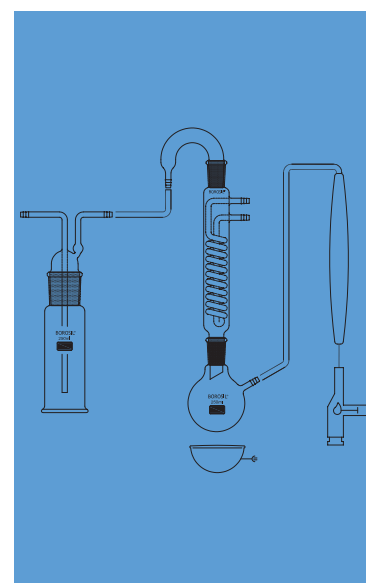

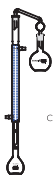
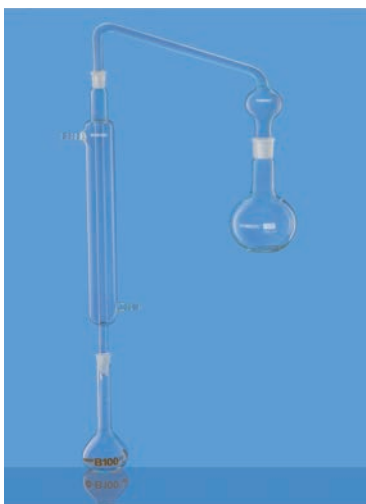

Cat No. 3454A22

3454 - R M VALUE APPARATUS

- Ideal for use in dairy industries
- Facilitates the determination of butter fat, and the analysis of oil, fat and waxes

Product Code	Capacity ml	Quantity Per Case	Price / Piece ₹
3454022	300	1	2525.00
3454A22*	300	1	3575.00

* As per IS 548 Part I Standard

Spare parts available on request

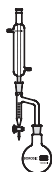

3602- DEAN STARK DISTILLING APPARATUS

As per IP

- Made of 3.3 borosilicate glass
- Uniform wall distribution of the Flask makes it suitable for heating
- Consists of a graduated 10 ml Receiver with 0.1 ml intervals

Product Code	Capacity of Receiver ml	Quantity Per Case	Price / set ₹
3602005	5	1 Set	2700.00
3602006	10	2 Set	2890.00

Spare parts available on request

Receiver 5ml / 10 ml graduated with 19 / 26 outer joint and 24 / 29 inner joint, note: 10 ml receiver is graduated from 1 ml to 10 ml in 0.1 ml intervals

Round bottom flask 1000 ml with 24 / 29 outer joint

Liebig condenser 200 mm with 19 / 26 joint

BOROSIL®

Dissolution Flask

- Manufactured from 3.3 borosilicate glass
- Individually certified to meet the USP standards (Ch. 711)
- Marked with unique identification code for traceability
- Flawless and smooth hemispherical base
- Ideal for use with Dissolution Apparatus

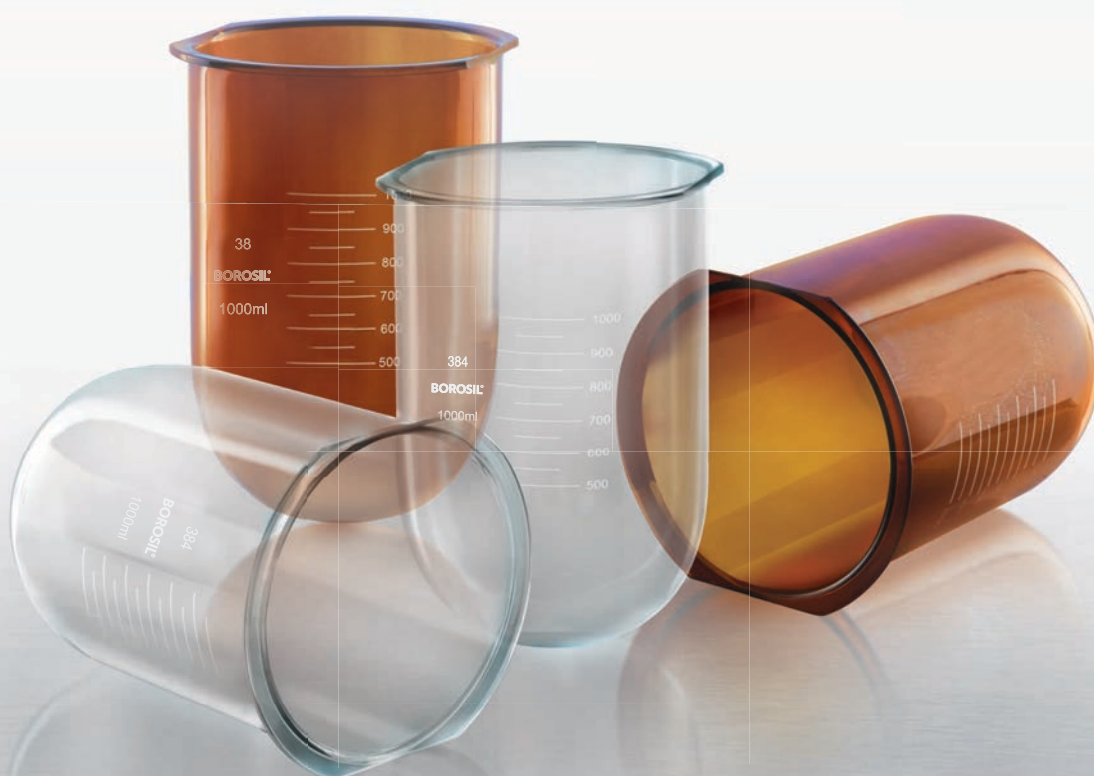

Proudly Made in India Since 1962

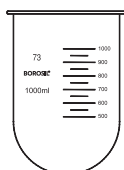

4265 - DISSOLUTION E-FLASK Clear, USP, With Certificate

- Designed for dissolution apparatus with side cut, as per USP
- Vessels conforms to all requirements of USP Ch. 711, provided with certificate
- Smooth hemispherical base with no flaws or defects, straight sides and a flat flange
- Graduated in intervals of 50 ml
- Ideal for Dissolution Apparatus for determining the dissolution characteristics of drugs in capsules and tablets

Product Code	Capacity ml	Approx O.D. x Height mm	Quantity Per Case	Price / Piece ₹
4265029	1000	131 x 173	6	2660.00

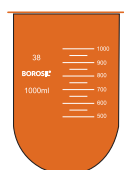

4267 - DISSOLUTION E-FLASK Amber, USP, With Certificate

- Designed for dissolution apparatus with side cut, as per USP
- These vessels conform to all the requirements of USP Ch. 711, provided with certificate
- Smooth hemispherical base with no flaws or defects, straight sides and a flat flange
- Graduated in intervals of 50 ml
- Ideal for dissolution apparatus for determining the dissolution characteristics of drugs in capsules and tablets
- Coloured in Amber to protect light-sensitive material
- The Amber colour is applied only to the external surface to prevent contamination with the testing material

Product Code	Capacity ml	Approx O.D. x Height mm	Quantity Per Case	Price / Piece ₹
4267029	1000	131 x 173	6	4790.00



4266 - DISSOLUTION L-FLASK Clear, USP, With Certificate

- Designed for dissolution apparatus with side cut, as per USP
- These vessels conforms to all the requirements of USP Ch. 711, provided with certificate
- Smooth hemispherical base with no flaws or defects, straight sides and a flat flange
- Two side-cuts at the flange
- Graduated in intervals of 50ml
- Ideal for determining the dissolution characteristics of drugs in capsules and tablets

Product Code	Capacity ml	Approx O.D. x Height mm	Quantity Per Case	Price / Piece ₹
4266029	1000	124 x 173	6	2840.00

4268 - DISSOLUTION L-FLASK

Amber, USP, With Certificate

- Designed for dissolution apparatus with side cut, as per USP
- These vessels conform to all the requirements of USP Ch. 711, provided with certificate
- Smooth hemispherical base with no flaws or defects, straight sides and a flat flange
- Two side-cuts at the range
- Graduated in intervals of 50 ml
- Ideal for determining the dissolution characteristics of drugs in capsules and tablets
- Coloured in Amber to protect light-sensitive material
- The Amber colour is applied only to the external surface to prevent contamination with the testing material



Product Code	Capacity ml	Approx O.D. x Height mm	Quantity Per Case	Price / Piece ₹
4268029	1000	124 x 173	6	5250.00

4270 - DISSOLUTION D-FLASKS

- Designed for Dissolution Apparatus without side cut, with silicon ring, as per USP
- Vessels conforms to all requirements of USP Ch. 711, provided with certificate
- Smooth hemispherical base with no flaws or defects, straight sides and a flat flange
- Graduated in intervals of 50ml
- Ideal for determining the dissolution characteristics of drugs in capsules and tablets

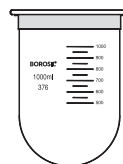

Product Code	Capacity ml	Approx O.D. x Height mm	Quantity Per Case	Price / Piece ₹
4270029	1000	132 x 168	6	9760.00

BOROSIL®

Laboratory Bottles, Caps & Accessories

Made from 3.3 Low Expansion
Borosilicate Glass



- ASPIRATOR BOTTLES
- BOD BOTTLES
- REAGENT BOTTLES
- CAPS AND POURING RINGS
- SOLUTION BOTTLES
- RELATIVE DENSITY BOTTLES
- SPECIFIC GRAVITY BOTTLES
- WEIGHING BOTTLES
- WASH BOTTLES
- GAS WASHING BOTTLES

Glass bottles are an integral part of laboratories across different sectors. Glass bottles are used for wide range of applications from long term storage of chemicals, reagents, solvents to the most demanding applications in the pharmaceutical and biopharmaceutical industries.

BOROSIL® bottles are designed with heavy wall thickness making them mechanically stronger to withstand wet or dry sterilization. The high chemical durability of glass ensures that most of the reagents can be stored in these bottles for long durations.



Reagent Bottles



BOROSIL® Laboratory bottles are chemically resistant and stable. When fitted with pouring ring, dripping can be totally eliminated. As there is only one size of screw thread for all bottles from 100 ml onwards, the screw caps and pouring rings are fully interchangeable. The bottles, pouring rings and caps are autoclavable and sterilizable.

For AMBER Bottles, ambering is done on the external surface only, hence properties within the bottle remain unchanged. It protects the media from light radiations of wavelengths between 300nm and 500 nm.

Made from 3.3 Low Expansion Borosilicate Glass



1220 - ASPIRATOR BOTTLES

With Tubulation and PP Cap

- Complies with IS 1388 (Part III), ISO 4796-3
- Supplied with GL45 screw caps and pouring ring made of polypropylene, autoclavable at 121°C
- All sizes have a durable matt-finished enamelled area for marking
- Suitable for storage of aggressive media



Product Code	Capacity ml	Approx O.D. x Height* mm	Thread Specification	Quantity Per Case	Price / Piece ₹
1220021	250**	70 x 140	GL 45	10	385.00
1220024	500**	86 x 176	GL 45	10	430.00
1220029	1000	101 x 225	GL 45	10	785.00
1220030	2000	136 x 260	GL 45	5	1280.00
1220033	5000	181 x 320	GL 45	1	7150.00
1220038	10000***	235 x 405	GL 45	1	12100.00
1220040	20000***	296 x 505	GL 45	1	21990.00

**Not covered in ISO / DIN standards.

*Height indicated is of Bottle only

***As per Borosil dimension

1240 - ASPIRATOR BOTTLES

With Socket Outlet For Stopcock and PP Cap

- Complies with IS 1388 (Part III), ISO 4796-3
- Supplied with GL45 screw caps and pouring ring made of polypropylene, autoclavable at 121°C
- All sizes have a durable matt-finished enamelled area for marking
- Suitable for storage of aggressive media



Product Code	Capacity ml	Approx O.D. x Height* mm	Thread Specification	Outlet Ground Joint Size	Quantity Per Case	Price / Piece ₹
1240029	1000	101 x 225	GL 45	19 / 26	10	1000.00
1240030	2000	136 x 260	GL 45	19 / 26	5	1435.00
1240033	5000	181 x 330	GL 45	29 / 32	1	8285.00
1240038	10000***	235 x 405	GL 45	29 / 32	1	11740.00
1240040	20000***	296 x 505	GL 45	29 / 32	1	20185.00

*Height indicated is of Bottle only

***As per Borosil dimension

Glass stopcock available on request



1245 - ASPIRATOR BOTTLES With I/C Glass Stopcock and PP Cap

- Complies with IS 1388 (Part III), ISO 4796-3
- Supplied with GL45 screw caps and pouring ring made of polypropylene, autoclavable at 121°C
- All sizes have a durable matt-finished enamelled area for marking
- Suitable for storage of aggressive media

Product Code	Capacity ml	Approx O.D. x Height* mm	Thread Specification	Outlet Ground Joint Size	Quantity Per Case	Price / Piece ₹
1245029	1000	101 x 225	GL 45	19 / 26	10	2780.00
1245030	2000	136 x 260	GL 45	19 / 26	4	3280.00
1245033	5000	181 x 323	GL 45	29 / 32	1	10875.00
1245038	10000***	235 x 405	GL 45	29 / 32	1	14885.00
1245040	20000***	296 x 505	GL 45	29 / 32	1	22110.00

*Height indicated is of Bottle only

***As per Borosil dimension

Spare glass stopcock available on request

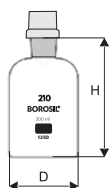

1250 - B.O.D. BOTTLES

- Complies with IS 9213
- Supplied with Interchangeable glass stopper and plastic cap
- Individual number printed on the bottle
- Used for determination of Biological Oxygen Demand in industrial effluents, waste and water

Product Code	Capacity ml	Approx O. D. x Height* mm	Quantity Per Case	Price / Piece ₹
1250013	60**	42 x 100	10	440.00
1250017	125**	55 x 120	10	540.00
1250022	300	70 x 143	30	630.00

*Height indicated is of Bottle only

**60 & 125 ml are not covered in standards

300 ml is for determination of B.O.D. in Industrial effluents, wastes and water as per method specified by the American Public Health Association

1500 - REAGENT BOTTLES

Narrow Mouth With I/C Glass Stopper

- Complies with IS 1388 (Part II), ISO 4796 - 2
- Supplied with solid glass stopper
- Printed with graduations using a durable white enamel
- Bottles are mechanically strong and chemical resistant with a sturdy ground neck

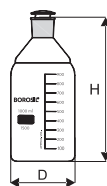

Product Code	Capacity ml	Approx O.D. x Height* mm	Neck Stopper Size	Quantity Per Case	Price / Piece ₹
1500013	60**	45 x 97	14 / 23	40	370.00
1500016	100	56 x 100	19 / 26	10	405.00
1500017	125**	56 x 120	19 / 26	50	395.00
1500021	250	70 x 138	19 / 26	10	385.00
1500024	500	86 x 177	24 / 29	10	405.00
1500029	1000	101 x 225	29 / 32	10	650.00
1500030	2000	136 x 260	34 / 35	10	1195.00

*Height indicated is of Bottle only

**60 & 125 ml is not covered in standards



1509 - REAGENT BOTTLES

Narrow Mouth With I/C Glass Stopper, Amber

- Complies with IS 1388 (Part II), ISO 4796 - 2
- Supplied with solid glass stopper
- Printed with graduations using a durable white enamel
- Bottles are mechanically strong and chemical resistant with a sturdy ground neck
- Uniform amber colour protects media from light radiation with a wave-length between 300 nm and 500 nm
- Ideal for use with light-sensitive media and for the long-term storage of substances

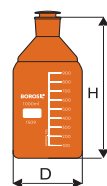

Product Code	Capacity ml	Approx O.D. x Height* mm	Neck Stopper Size	Quantity Per Case	Price / Piece ₹
1509013	60**	45 x 97	14 / 23	20	530.00
1509016	100	56 x 100	14 / 23	10	585.00
1509017	125**	56 x 120	19 / 26	20	550.00
1509021	250	70 x 138	19 / 26	10	670.00
1509024	500	86 x 177	24 / 29	10	780.00
1509029	1000	101 x 225	29 / 32	5	1010.00
1509030	2000	136 x 260	34 / 35	5	1925.00

*Height indicated is of Bottle only

**60 & 125 ml is not covered in standards



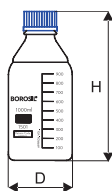

1501 - REAGENT BOTTLES Narrow Mouth With Screw Cap

- Complies with IS 1388 (Part I), ISO 4796 - 1
- Supplied with screw caps and pouring ring made of polypropylene, autoclavable at 121°C
- Printed with graduations and retrace code using a durable white enamel
- 100 ml to 20000 ml Bottles have uniform GL 45 thread
- Mechanically strong and chemical resistant
- Ideal for storage of chemicals, reagents, media

Product Code	Capacity ml	Approx O.D. x Height* mm	Thread Specification	Quantity Per Case	Price / Piece ₹
1501006	10**#	36 x 50	GL 25	10	435.00
1501009	25#	36 x 70	GL 25	20	290.00
1501012	50	46 x 87	GL 32	20	330.00
1501016	100	56 x 100	GL 45	10	345.00
1501018	150**#	60 x 120	GL 45	10	370.00
1501021	250	70 x 138	GL 45	10	355.00
1501024	500	86 x 177	GL 45	10	380.00
1501029	1000	101 x 225	GL 45	10	595.00
1501030	2000	136 x 260	GL 45	10	1065.00
1501031	3000**	158 x 295	GL 45	2	4995.00
1501033	5000***	181 x 320	GL 45	1	5990.00
1501038	10000***	235 x 405	GL 45	1	11040.00
1501040	20000***	296 x 505	GL 45	1	18800.00

- *Height indicated is of Bottle only

- #Without Pouring Ring

- **Not covered in any standard

- ***As per Borosil Dimension

1519 - REAGENT BOTTLES

Narrow Mouth With Screw Cap, Amber

- Complies with IS 1388 (Part I), ISO 4796 - 1
- Supplied with screw caps and pouring ring made of polypropylene, autoclavable at 121°C
- Printed with graduations and retrace code using a durable white enamel
- 100 ml to 20000 ml Bottles have uniform GL 45 thread
- Mechanically strong and chemical resistant
- Uniform amber colour protects media from light radiation with a wave-length between 300 nm and 500 nm
- Ideal for use with light-sensitive media and for the long-term storage of substances



Product Code	Capacity ml	Approx O.D. x Height* mm	Thread Specification	Quantity Per Case	Price / Piece ₹
1519006	10**#	36 x 50	GL 25	10	535.00
1519009	25#	36 x 70	GL 25	20	450.00
1519012	50#	46 x 87	GL 32	20	520.00
1519016	100	56 x 100	GL 45	10	540.00
1519021	250	70 x 138	GL 45	10	570.00
1519024	500	86 x 177	GL 45	10	680.00
1519029	1000	101 x 225	GL 45	10	890.00
1519030	2000	136 x 260	GL 45	10	1670.00
1519031	3000**	158 x 295	GL 45	2	8910.00
1519033	5000***	183 x 320	GL 45	1	9195.00
1519038	10000***	235 x 405	GL 45	1	13390.00
1519040	20000***	296 x 500	GL 45	1	19790.00

- *Height indicated is of Bottle only

#Without Pouring rings

**Not covered in any standard

***As per BOROSIL dimensions

1503 - SCREW CAPS FOR BOTTLES

- Made of polypropylene (PP)
- Supplied with PP pouring rings
- Autoclavable at 121°C
- Available in 5 different colours



Product Code	Colour Description	Thread Specification	Quantity Per Case	Price / Piece ₹
1503C01	Blue	GL 45	10	85.00
1503C02	Orange	GL 45	10	90.00
1503C03	Yellow	GL 45	10	90.00
1503C04	Green	GL 45	10	90.00
1503C05	Grey	GL 45	10	90.00
1503C06	Blue	GL 25	10	80.00
1503C07	Blue	GL 32	10	80.00
1503C08	Blue	GL 36	10	80.00

HSN Code: 39235010



1505 - HIGH TEMPERATURE RESISTANT SCREW CAPS

- Made of Polybutylene Terephthalate (PBT)
- Supplied with a silicone/PTFE liner and pouring ring
- Temperature resistance: - 40°C to +200°C
- Withstand sterilization conditions: hot air sterilization in oven upto 200°C and steam sterilization in autoclave at 121°C

Product Code	Colour Specification	Thread Specification	Quantity Per Case	Price / Piece ₹
1505C01	Red	GL - 45	10	550.00

HSN Code: 39235010

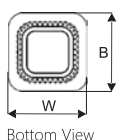
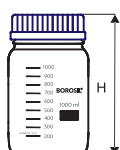

Bottom View

1506 - REAGENT BOTTLES Wide Mouth With Screw Cap, Square

- Supplied with GL80 screw caps and pouring ring made of polypropylene, autoclavable at 121°C
- Square shape enables stacking of bottles during usage, storage and transport
- Extra wide GL 80 neck gives ease of pouring & filling of liquids as well as powders
- Large stable base helps prevent tumbling of the bottle
- Ideal for storage and transfer of pharma and biopharma products

Product Code	Capacity ml	Approx B x W x H mm	Thread Specification Approx O.D. mm	Quantity Per Case	Price / Piece ₹
1506024	500	94 x 94 x 141	GL-80	10	915.00
1506029	1000	105 x 105 x 187	GL-80	10	1010.00
1506030	2000	115 x 115 x 260	GL-80	10	1585.00
1506033	5000	160 x 160 x 357	GL-80	1	9780.00

*Height indicated is of Bottle only

Product code 1507



AMBER Colour Bottles are available on request.

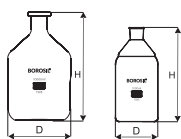

1585 - SOLUTION BOTTLES With Tooled Neck

- Complies with IS 1388 (Part II), ISO 4796 - 2
- 10, 20 & 50 litre bottles specially designed for handling and storing culture media
- All sizes have a durable matt-finished enamelled area for marking

Product Code	Capacity ml	Approx O.D. x Height mm	Approx Neck I. D. mm	Quantity Per Case	Price / Piece ₹
1585021	250	70 x 145	18	20	350.00
1585024	500	86 x 180	23	20	375.00
1585029	1000	101 x 230	28	10	620.00
1585030	2000	136 x 285	33	10	1050.00
1585031	3000	158 x 255	44	4	3300.00
1585033	5000	183 x 330	44	1	6170.00
1585038	10000*	235 x 430	54	1	10900.00
1585040	20000*	296 x 530	54	1	17510.00
1585046	50000	417 x 665	89	1	88590.00

*As per Borosil dimensions

1589 - SOLUTION BOTTLES

With Tooled Neck, Amber

- Complies with IS 1388 (Part II), ISO 4796 - 2
- 10, 20 & 50 litre bottles specially designed for handling and storing culture media
- All sizes have a durable matt-finished enamelled area for marking
- Uniform amber colour protects media from light radiation with a wave-length between 300 nm and 500 nm
- Ideal for use with light-sensitive media and for the long-term storage of substances



Laboratory Bottles,
Caps & Accessories

Product Code	Capacity ml	Approx O.D. x Height mm	Approx Neck I. D. mm	Quantity Per Case	Price / Piece ₹
1589021	250	70 x 145	18	10	660.00
1589024	500	86 x 180	23	20	690.00
1589029	1000	101 x 230	28	5	975.00
1589030	2000	136 x 255	33	5	1740.00
1589031	3000	158 x 255	44	4	4455.00
1589033	5000	183 x 330	44	1	8330.00
1589038	10000*	235 x 430	54	1	14715.00
1589040	20000*	296 x 530	54	1	23640.00

*As per Borosil dimensions

1624 - RELATIVE DENSITY BOTTLES

(Pyknometer) With I/C PTFE Stopper With Certificate

- Supplied with I/C PTFE (Teflon) stopper
- These bottles are mechanically strong and chemical resistant
- All sizes have a durable matt-finished enamelled area for marking
- Provided with certificate

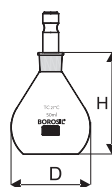

Product Code	Capacity ml	Capacity Tolerance ± ml	Max. Body Dia x Height mm	Size of Inter-Changeable Stopper	Quantity Per Case	Price / Piece ₹
1624006	10	0.3	29 x 48	10 / 15	5	1015.00
1624009	25	0.8	40 x 55	10 / 15	5	1195.00
1624012	50	1	50 x 65	10 / 15	5	1260.00

1625 - RELATIVE DENSITY BOTTLES

(Pyknometer) With I/C PTFE Stopper

- Supplied with I/C PTFE (Teflon) stopper
- Complies with IS 5717, DIN / ISO 3507
- These bottles are mechanically strong and chemical resistant
- All sizes have a durable matt-finished enamelled area for marking

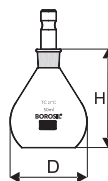

Product Code	Capacity ml	Capacity Tolerance ± ml	Max. Body Dia x Height mm	Size of Inter-Changeable Stopper	Quantity Per Case	Price / Piece ₹
1625006	10	1	29 x 48	10 / 15	10	480.00
1625009	25	2	40 x 55	10 / 15	10	530.00
1625012	50	3	50 x 65	10 / 15	5	570.00



1627 - SPECIFIC GRAVITY BOTTLES (PYKNOMETER) With Thermometer And Capillary Side Tube

- Complies with IS 5717, DIN / ISO 3507
- These bottles are mechanically strong and chemical resistant
- All sizes have a durable matt-finished enamelled area for marking
- Supplied with thermometer alongwith certificate for thermometer

Product Code	Capacity ml	Tolerance ± ml	Max. Body Dia x Height mm	Size of I/C Stopper	Quantity Per Case	Price / Piece ₹
1627006	10	1	29 x 48	10 / 19	5	1370.00
1627009	25	2	40 x 55	10 / 19	5	1605.00
1627012	50	3	50 x 65	10 / 19	5	1740.00

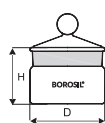

Squat Form



Tall Form

1630 - WEIGHING BOTTLES With I/C Glass Lid

- Complies with IS 1574
- These bottles are mechanically strong and chemical resistant

Product Code	Capacity ml	Approx O.D. x Height* mm	Quantity Per Case	Price / Piece ₹
1630005	5	20 x 40	30	310.00
1630007	15	25 x 50	10	320.00
1630008	20**	50 x 25	10	670.00
1630009	25	30 x 60	10	400.00
1630011	40**	60 x 30	10	950.00
1630013	60	40 x 80	5	600.00

*Height indicated is of Bottle only

**Squat Form

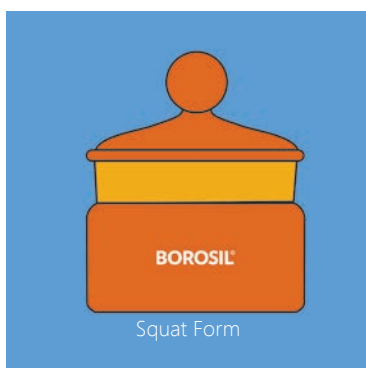

Squat Form



Tall Form

1631 - WEIGHING BOTTLES With I/C Glass Lid, Amber

- Complies with IS 1574
- These bottles are mechanically strong and chemical resistant
- Suitable for light sensitive substance.

Product Code	Capacity ml	Approx O.D. x Height* mm	Quantity Per Case	Price / Piece ₹
1631005	5	20 x 40	30	430.00
1631007	15	25 x 50	10	450.00
1631008	20**	50 x 25	10	885.00
1631009	25	30 x 60	10	520.00
1631011	40**	60 x 30	10	1235.00
1631013	60	40 x 80	5	790.00

*Height indicated is of Bottle only

**Squat Form

1640 - DROPPING BOTTLES

With Glass Dropper & Rubber Teat

- Supplied with interchangeable ground joint glass dropper and rubber teat
- Highly chemical resistance

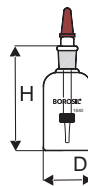

Product Code	Capacity ml	Approx O.D. x Height mm	Socket Size	Quantity Per Case	Price / Piece ₹
1640010	30	34 x 86	14 / 23	10	300.00
1640013	60	42 x 100	14 / 23	10	410.00
1640017	125	55 x 120	19 / 26	10	430.00
1640021	250	65 x 147	19 / 26	10	570.00



1650 - DROPPING BOTTLES

With Glass Dropper & Rubber Teat, Amber

- Supplied with interchangeable ground joint glass dropper and rubber teat
- Highly chemical resistance
- Suitable for light sensitive substance.



Product Code	Capacity ml	Approx O.D. x Height mm	Socket Size	Quantity Per Case	Price / Piece ₹
1650010	30	35 x 84	14 / 19	10	495.00
1650013	60	42 x 100	14 / 19	10	660.00
1650017	125	55 x 120	19 / 26	10	710.00
1650021	250	65 x 147	19 / 26	10	930.00



1660 - GLASS WASH BOTTLE

Set With I/C Stopper

- These bottles are mechanically strong and chemical resistant
- All sizes have a durable matt-finished enamelled area for marking

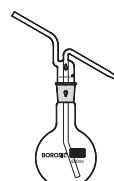

Product Code	Capacity ml	Approx OD mm	Approx Height mm	Size of Inter-changeable Stopper	Quantity Per Case Set	Price / Piece ₹
1660021	250	85	130	24 / 29	5	700.00
1660024	500	105	160	24 / 29	5	910.00
1660029	1000	131	195	29 / 32	5	1080.00



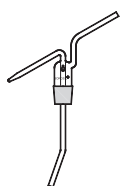

1661 - STOPPER FOR GLASS WASH BOTTLE

Product Code	Capacity ml	Size of Inter-changeable Stopper	Quantity Per Case	Price / Piece ₹
1661021	250	24 / 29	5	500.00
1661024	500	24 / 29	5	540.00
1661029	1000	29 / 32	5	560.00

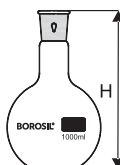

1662 - FLASK FOR GLASS WASH BOTTLE

Product Code	Capacity ml	Approx OD mm	Approx Height mm	Size of Inter-changeable Stopper	Quantity Per Case	Price / Piece ₹
1662021	250	85	130	24 / 29	5	460.00
1662024	500	105	160	24 / 29	5	720.00
1662029	1000	131	195	29 / 32	5	970.00

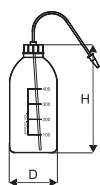

166P - LDPE PLASTIC WASH BOTTLES

Squeeze Type

- Fitted with delivery tubes
- Bottles and delivery tube made of chemically resistant, low density polyethylene
- Flexible, tough, light weight, and practically unbreakable in use
- Squeezing the bottle produces a steady controllable stream or a few drops.
- Delivery tubes are mounted in polypropylene screw caps
- Tips on delivery tubes are removable

Product Code	Capacity ml	Approx Diameter mm	Bottle Height mm	Quantity Per Case	Price / Piece ₹
166024	500	75	167	36	115.00

1760 - GAS WASHING (DRESCHEL) BOTTLES

Set With I/C Stopper

- Complies with IS 11990
- These bottles are mechanically strong and chemical resistant
- All sizes have a durable matt-finished enamelled area for marking



Product Code	Capacity ml	Approx O.D x Height (bottle) mm	Size of Inter-changeable Stopper	Quantity Per Case Set	Price / Piece ₹
1760017	125	50 x 165	29 / 32	5	1110.00
1760021	250	60 x 190	29 / 32	5	1190.00
1760024	500	70 x 245	29 / 32	5	1420.00



1761 - STOPPER FOR GAS WASHING (DRESCHEL) BOTTLES

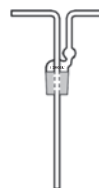

Product Code	Capacity ml	Quantity Per Case	Price / Piece ₹
1761017	125	5	625.00
1761021	250	5	650.00
1761024	500	5	740.00



1762 - BOTTLES FOR GAS WASHING (DRESCHEL) BOTTLES

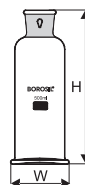

Product Code	Capacity ml	Approx O.D x Height mm	Quantity Per Case	Price / Piece ₹
1762017	125	50 x 165	5	1000.00
1762021	250	60 x 190	5	1095.00
1762024	500	70 x 245	5	1340.00





1764 - GAS SAMPLING TUBES With Glass Stopcocks

- Complies with DIN 12473

Product Code	Capacity ml	Quantity Per Case	Price / Piece ₹
1764017	125*	10	630.00
1764021	250*	10	740.00
1764024	500	10	1050.00
1764029	1000	10	1790.00

* Not covered in standards

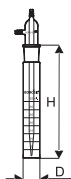

1765 - IMPINGER

- Complies with IS 5182 (Part-VI)
- These bottles are mechanically strong and chemical resistant

Product Code	Capacity ml	Approx O. D. x Height mm	Quantity Per Case Set	Price / Piece ₹
1765058	35	26 x 220	10	465.00



1665 - PLASTIC CLAMPS FOR JOINT FITTINGS

- Made of polypropylene for joint fittings

Product Code	Joint mm	Quantity Per Case	Price / Piece ₹
1665B14	B 14	10	55.00
1665B19	B 19	10	55.00
1665B24	B 24	10	60.00
1665B29	B 29	10	60.00

HSN Code: 39235010

INDUSTRIAL MAGNETIC STIRRER

Solutions for
Stirring Applications



ROBUST



CIP



SIP



SCAN TO
KNOW MORE

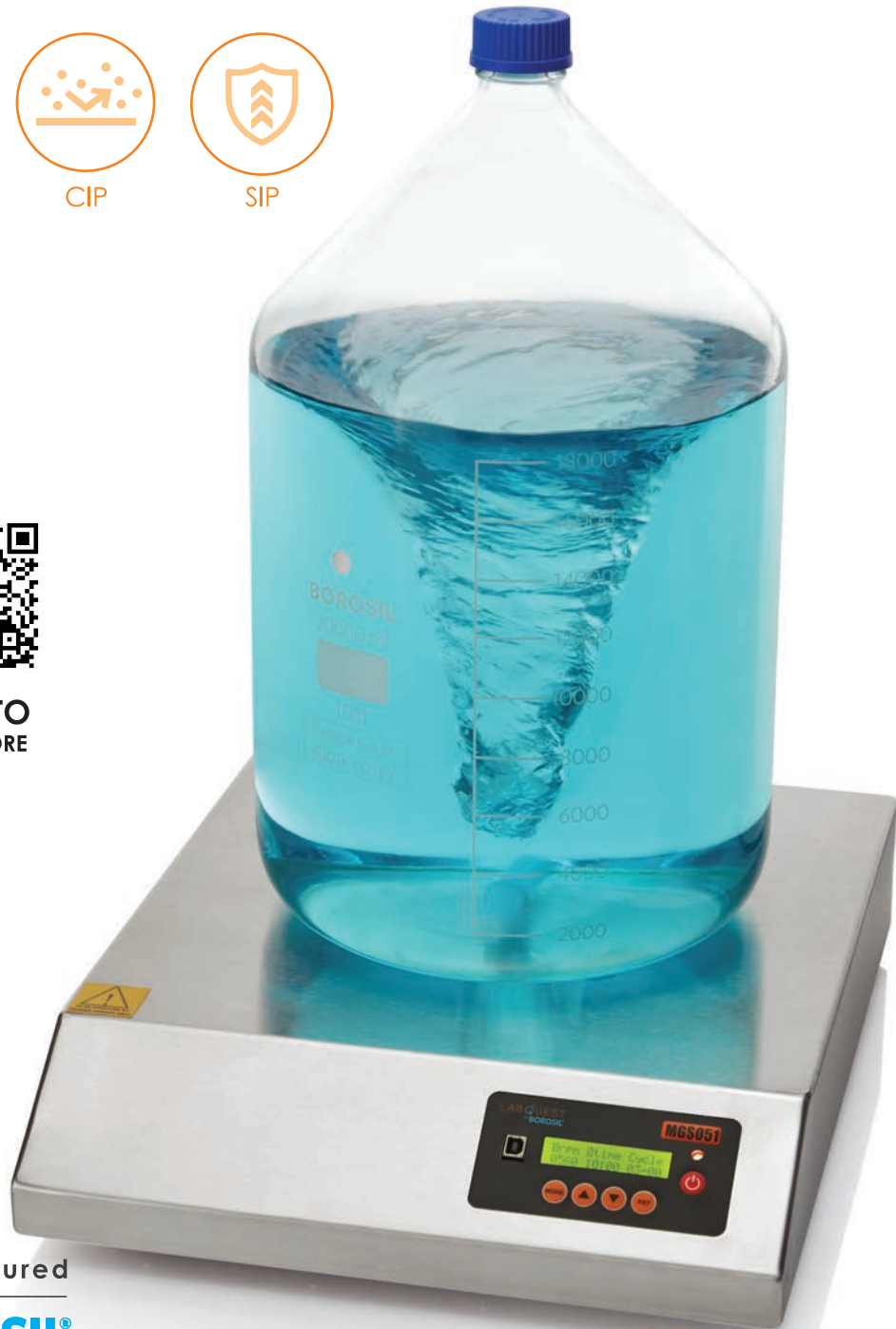

Manufactured
by
BOROSIL®
TECHNOLOGIES

BOROSIL[®]

General Laboratory Glassware

Made from 3.3 Low Expansion Borosilicate Glass



- BEAKERS
- CONES
- CONDENSERS
- CHROMATOGRAPHY COLUMNS
- DESICCATORS
- DISHES
- DISTILLING APPARATUS
- WATER DISTILLATION UNITS
- EXTRACTORS
- FLASKS
- FUNNELS
- GLASSWARE PARTS & ACCESSORIES
- MOTOR & PESTLE
- MUSEUM JARS
- TEST TUBES
- TUBES

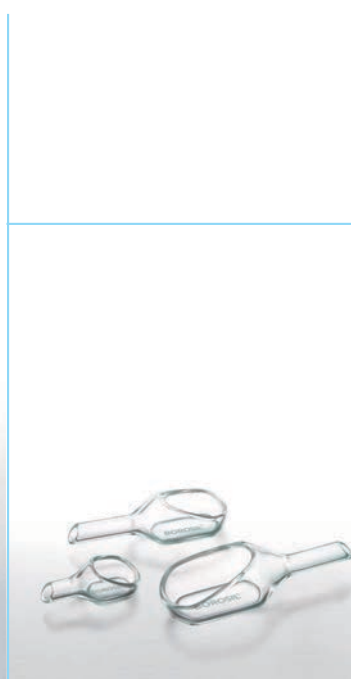

Beakers

Whether it is research, industry or education, the Beaker has a wide range of applications. This simple container, used for stirring and mixing liquids, is also ideal for heating them. Controlled wall thickness at the sides, radius and the base, ensures a fine balance between the thermal resistance and mechanical strength, to enable effective heating. Many Beakers also have a spout that makes pouring easier and more precise.

BOROSIL® Glasswares are best-in-class products with several advantages. They have a high level of thermal shock resistance and a high operating temperature. Besides using USP type I borosilicate glass constant quality control checks are conducted throughout the production process to ensure uniformity of the wall thickness. Such uniform wall thickness distribution prevents uneven expansion and stressing of the glass that often results in a failure.

Beakers are mainly used as heating vessels. The tall-shape design of the Beaker is ideal for heating in a liquid bath, especially when the contents need to be kept distinctly apart from the surrounding medium or materials.

BOROSIL® brand Low form Beaker (Cat No. 1000) and **BOROSIL®** brand Tall Form Beaker (Cat No. 1060) are two popular styles used for storage and mixing.

BOROSIL® offers full range of beakers to suit every application.



Made from 3.3 Low Expansion Borosilicate Glass



1000 - LOW FORM BEAKER

With Spout

- Complies with IS 2619 /ISO 3819 and DIN 12331
- The spout design enables clean and precise pouring
- Graduated to indicate the approximate content
- Uniform wall thickness distribution improves mechanical & thermal properties & makes it ideal for heating liquids
- The easy-to-read scale and large labelling field makes marking easier
- High resistance to chemical attack

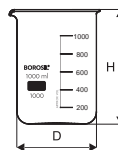

Product Code	Capacity ml	Approx O.D. x Height mm	Quantity Per Case	Price / Piece ₹
1000005	5*	22 x 30	20	120.00
1000006	10*	26 x 35	20	120.00
1000009	25	34 x 50	60	120.00
1000D12	50	42 x 60	60	80.00
1000D16	100	50 x 70	40	80.00
1000D18	150	60 x 80	40	80.00
1000D21	250	70 x 95	40	90.00
1000D23	400	80 x 110	40	145.00
1000D24	500	85 x 115	40	140.00
1000D25	600	90 x 125	40	185.00
1000028	800	100 x 135	20	290.00
1000D29	1000	105 x 145	20	290.00
1000D30	2000	130 x 185	6	585.00
1000D31	3000	150 x 215	4	1490.00
1000D33	5000	170 x 270	4	2190.00
1000D38	10000	220 x 350	1	7060.00

* 5 ml and 10 ml Beakers are not graduated.

1040 - TALL FORM BEAKER

Without Spout

- Complies with IS 2619 / ISO 3819 and DIN 12331
- Graduated to indicate the approximate content
- Uniform wall thickness distribution improves mechanical & thermal properties & makes it ideal for heating liquids
- The easy-to-read scale and large labelling field makes marking easier
- High resistance to chemical attack
- Ideal for titrations

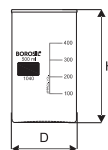

Product Code	Capacity ml	Approx O.D. x Height mm	Quantity Per Case	Price / Piece ₹
1040012	50	38 x 70	40	140.00
1040016	100	48 x 80	40	145.00
1040018	150	54 x 95	40	155.00
1040021	250	60 x 120	40	145.00
1040024	500	80 x 140	20	205.00
1040025	600	80 x 150	20	270.00
1040028	800	90 x 175	20	320.00
1040029	1000	95 x 180	20	400.00

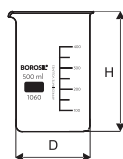

1060 - TALL FORM BEAKER

With Spout

- Complies with IS 2619 / EN ISO 3819 and DIN 12331
- Graduated to indicate the approximate content
- The spout design enables clean and precise pouring
- Uniform wall thickness distribution improves mechanical & thermal properties & makes it ideal for heating liquids
- The easy-to-read scale and large labelling field makes marking easier
- High resistance to chemical attack
- Ideal for titrations

Product Code	Capacity ml	Approx O.D. x Height mm	Quantity Per Case	Price / Piece ₹
1060012	50	38 x 70	40	145.00
1060D16	100	48 x 80	40	150.00
1060018	150	54 x 95	40	155.00
1060D21	250	60 x 120	40	150.00
1060D24	500	80 x 140	20	205.00
1060025	600	80 x 150	20	320.00
1060028	800	90 x 175	20	380.00
1060D29	1000	95 x 180	20	405.00

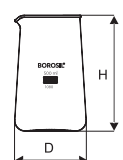

1080 - PHILLIP (CONICAL) BEAKER

With Spout

- Conical shape (Phillips pattern) with spout
- Its mouth is smaller in diameter than its base
- The Phillips Beaker is ideal for measuring, containment, mixing and decanting

Product Code	Capacity ml	Approx O.D. x Height mm	Quantity Per Case	Price / Piece ₹
1080021	250	68 x 110	40	655.00
1080024	500	88 x 145	40	820.00

BOROSIL®

Tongs For Beakers & Flasks

- Made of stainless steel
- Used to handle hot beakers
- Provided with silicon sleeves or in fibre glass yarn to resist direct flame



Proudly Made in India Since 1962

For more details please refer page no. 201

ativ HOT PLATE
MAGNETIC STIRRERS

HLS 200



SCAN TO
KNOW MORE



Manufactured
by
BOROSIL®
TECHNOLOGIES



STIRRING



HEATING

Cones

Cones are used to determine small amounts of suspended matter in sewage by the Imhoff Sedimentation Method.

Made from 3.3 Low Expansion Borosilicate Glass



2160 - IMHOFF CONE

Sharp Tip

- Complies with IS 7232
- Graduated from 0 to 1 ml in 0.1 ml divisions
- Graduated from 1 to 10 ml in 0.5 ml divisions
- 10 to 40 ml in 1 ml divisions also marked at 1000 ml
- Facilitates the determination of the amount of sediment in sewage or industrial waste

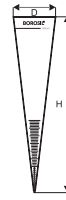

Product Code	Approx Total Height mm	Approx Top Diameter mm	Quantity Per Case	Price / Piece ₹
2160094	454	110	1	5240.00

Cones

2180 - IMHOFF CONE

Blunt Tip

- Complies with IS 7232
- The blunt tip increases its ruggedness and cleaning ease
- Ideal for use with heavy sediments where the ability to read small volumes is unimportant
- Facilitates the determination of the amount of sediment in sewage or industrial waste



Product Code	Approx Total Height mm	Approx Top Diameter mm	Quantity Per Case	Price / Piece ₹
2180093	439	110	1	5350.00

Condensers

A Condenser is designed to facilitate the cooling of hot vapours and liquids. It is structured in the form of a large glass tube, containing a smaller glass tube running through its entire length. Hot fluids pass through this small inner tube.

Typically, the outer glass tube has two hose connections to aid the passing of a coolant (usually tap water or chilled water/anti-freeze mixture). The coolant is introduced through the lower fitting, while the higher fitting serves as the exit point. Entering the coolant at the cooler point is a critical aspect as it helps maintain a smooth and correctly directed thermal gradient. This in turn, maximises efficiency and minimises the risk of thermal shock to adjacent glassware. Multiple Condensers may be connected in a series. Usually, a high flow rate is not essential for maintaining a cooling surface.

Special care should be taken while choosing Condensers keeping in mind their distillation rates, reflux rates and temperature gradients.

Borosil offers you the choice of a wide range of Condensers.

Made from 3.3 Low Expansion
Borosilicate Glass



2340 - LIEBIG CONDENSER

With Sealed Inner Tube

- The light wall of the inner tube facilitates efficient heat transfer
- Low cooling capacity
- Used for distillate separation

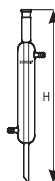

Product Code	Approx Jacket Length mm	Approx Overall Height mm	Ground Joint	Quantity Per Case	Price / Piece ₹
2340087	200	350	19 / 15	5	550.00
2340090	300	450	19 / 15	5	470.00
2340092	400	550	19 / 15	5	490.00
2340095	500	650	19 / 15	5	595.00



2400 - LIEBIG CONDENSER

With Drip Tip

- With interchangeable inner and outer joints
- The light wall of the inner tube facilitates efficient heat transfer
- Low cooling capacity
- Used for distillate separation

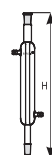

Product Code	Approx Jacket Length mm	Approx Overall Height mm	Ground Joint		Quantity Per Case	Price / Piece ₹
			Socket	Cone		
2400087	200	350	19 / 26	19 / 26	5	550.00
2400090	300	450	24 / 29	24 / 29	5	610.00
2400092	400	550	24 / 29	24 / 29	5	700.00

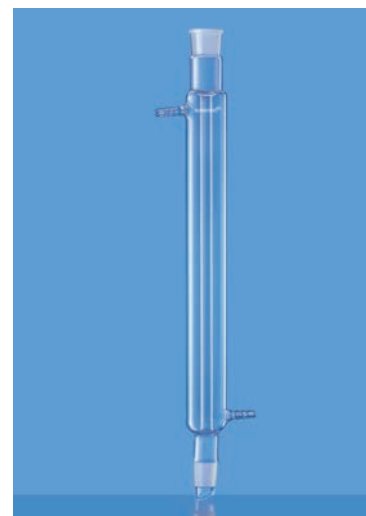

2480 - ALLIHN CONDENSER

With Drip Tip

- With Interchangeable Inner and Outer Joint
- Greater surface area than the Liebig Condenser owing to a series of bulbs, resulting in higher cooling capacity
- Ideal for laboratory scale refluxing

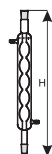

Product Code	Approx Jacket Length mm	Approx Overall Height mm	Ground Joint		Quantity Per Case	Price / Piece ₹
			Socket	Cone		
2480087	200	350	19 / 26	19 / 26	5	700.00
2480090	300	450	24 / 29	24 / 29	5	740.00
2480092	400	550	24 / 29	24 / 29	5	860.00
2480096	600	750	29 / 32	29 / 32	5	1160.00



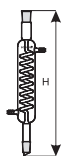

2560 - GRAHAM COILED CONDENSER

With Drip Tip

- With Interchangeable Inner and Outer Joint
- The coiled condensation tubes result in greater surface area for cooling
- Designed with top standard taper outer and lower inner drip tip joint

Product Code	Approx Jacket Length mm	Approx Overall Height mm	Ground Joint		Quantity Per Case	Price / Piece ₹
			Socket	Cone		
2560090	300	450	24 / 29	24 / 29	5	845.00
2560092	400	550	24 / 29	24 / 29	5	870.00
2560095	500	650	24 / 29	24 / 29	5	1095.00

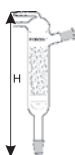

2640 - FRIEDRICH CONDENSER

With Drip Tip

- With Interchangeable Inner and Outer Joint
- Specially designed inner spiral tubes ensure along vapour path
- Offer better heat transfer and anti-flooding capabilities

Product Code	Approx Jacket Length mm	Ground Joint		Quantity Per Case	Price / Piece ₹
		Socket	Cone		
2640097	350	24 / 29	24 / 29	5	3395.00



2641 - DOUBLE SURFACE CONDENSER

Product Code	Approx Jacket Length mm	Approx Overall Height mm	Ground Joint	Quantity Per Case	Price / Piece ₹
2641087	200	345	19 / 26	5	2160.00
2641187	200	360	24 / 29	5	2300.00
2641090	300	454	19 / 26	5	2845.00
2641190	300	450	24 / 29	5	3110.00

The above condensers are widely used in research labs. A double-surface condenser has a water jacket both on the outside and through the centre of the condensing tube. It is needed where the condensed liquid is very volatile. Hence for distilling ethers, alcohols, esters, aromatics, petroleum products and essential oils these condensers are widely used.

6100 - CHROMATOGRAPHY COLUMNS

Plain With Glass Stopcock

- Designed with straight bore stopcock that increases the life as compared to PTFE key stopcocks
- The glass stopcock enhances control and facilities smoother action
- Generally used for purification of individual compounds from mixtures of compounds



Product Code	Capacity ml	Bore mm	Quantity Per Case	Price / Piece ₹
6100060	200	10	5	385.00
6100061	300	10	5	415.00
6100062	300	18	5	465.00
6100063	450	30	5	585.00
6100064	500	10	5	450.00
6100065	500	18	5	470.00
6100066	600	30	5	770.00
6100067	600	40	5	1005.00
6100068	1000	40	4	2055.00

Note : The Columns with Boroflow & PTFE stopcock will be made available on request

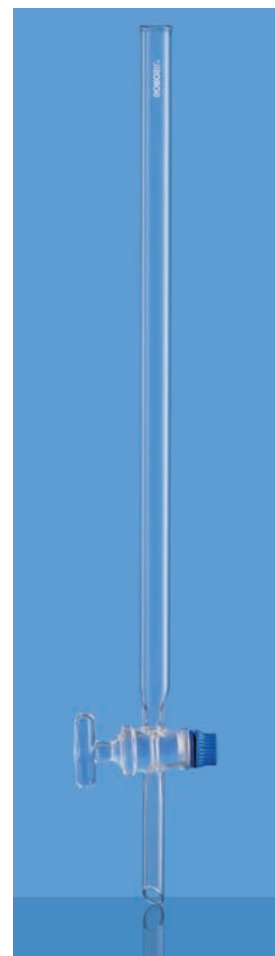

Chromatography Columns

6101 - CHROMATOGRAPHY COLUMNS

With Sintered Disc & Glass Stopcock

- Designed with straight bore stopcock that increases the life as compared to PTFE key stopcocks
- The glass stopcock enhances control and facilities smoother action
- Columns are added with a Sintered Disc for good results
- Generally used for purification of individual compounds from mixtures of compounds
- Columns are added with a Sintered Disc (Grade I) for good result



Product Code	Capacity ml	Bore mm	Quantity Per Case	Price / Piece ₹
6101060	200	10	5	650.00
6101061	300	10	5	670.00
6101062	300	18	5	830.00
6101063	450	30	5	1030.00
6101064	500	10	5	770.00
6101065	500	18	5	900.00
6101066	600	30	5	1065.00
6101067	600	40	5	1760.00
6101068	1000	40	4	2395.00

Note : The Columns with Boroflow & PTFE stopcock will be made available on request

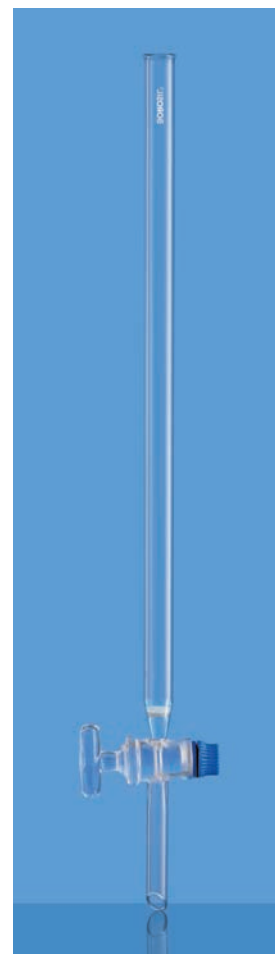

Desiccators

BOROSIL® brand Desiccators are equipped with bodies and covers that have great strength and utility. The body is designed with a streamlined contour that facilitates easy cleaning of the used desiccant. Any desiccant such as sulphuric acid, phosphoric pentoxide, calcium chloride or silica gel may be used in Borosil brand Desiccators. For your convenience, all Borosil brand Plain Desiccators of the same size have interchangeable covers and bodies. When the ground surface is cleaned and greased, Vacuum type Desiccators hold a vacuum of 500 mm of mercury.



3082 - DESICCATOR SET With Cover & Porcelain Plate

- Complies with IS 6128
- Supplied with cover and porcelain plate, plastic knob
- Simple design for drying under atmospheric pressure
- Ground glass flanges
- Plates are positioned on an internal ledge within the base
- Generally used for drying of moist products, and for storage of moisture-sensitive substances

Product Code	Nominal Diameter mm	Approx Flange OD mm	Approx Total Height mm	Quantity Per Case	Price / Piece ₹
3082041	100	153	173	1	7155.00
3082042	150	213	205	1	8350.00
3082043	200	272	272	1	11645.00
3082044	250	333	323	1	14870.00
3082045	300	395	344	1	20525.00

Spare cover and porcelain plate available on request



3084 - DESICCATOR SET With Cover & Porcelain Plate Amber

- Complies with IS 6128
- Supplied with with cover and porcelain plate, plastic knob
- Simple design for drying under atmospheric pressure
- Ground glass flanges
- Plates are positioned on an internal ledge within the base
- Amber coating to protect light sensitive chemicals
- Generally used for drying of moist products, and for storage of moisture-sensitive substances

Product Code	Nominal Diameter mm	Approx Flange OD mm	Total Height mm	Quantity Per Case	Price / Piece ₹
3084041	100	153	173	1	9460.00
3084042	150	213	205	1	10840.00
3084043	200	272	272	1	13970.00
3084044	250	333	323	1	17750.00
3084045	300	395	344	1	27780.00

Spare cover and porcelain plate available on request

3083 - VACUUM DESICCATOR SET

With Cover & Porcelain Plate

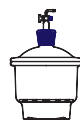

- Complies with IS 6128
- Supplied with with cover having stopcock with PTFE spindle, porcelain plate and plastic knob
- Simple design for drying under atmospheric pressure
- Ground glass flanges
- Plates are positioned on an internal ledge within the base
- Designed for use under vacuum
- Generally used for drying of moist products, and for storage of moisture-sensitive substances

Product Code	Nominal Diameter mm	Approx Flange OD mm	Total Height mm	Quantity Per Case	Price / Piece ₹
3083041	100	153	173	1	10965.00
3083042	150	213	205	1	16490.00
3083043	200	272	272	1	18510.00
3083044	250	333	323	1	25695.00
3083045	300	395	344	1	32285.00

Spare cover, porcelain plate and stopcock available on request

Desiccators

3085 - VACUUM DESICCATOR SET

With Cover & Porcelain Plate, Amber



- Complies with IS 6128
- Supplied with with cover having stopcock with PTFE spindle, porcelain plate and plastic knob
- Simple design for drying under atmospheric pressure
- Ground glass flanges
- Plates are positioned on an internal ledge within the base
- Designed for use under vacuum
- Amber coating to protect light sensitive chemicals
- Generally used for drying of moist products, and for storage of moisture-sensitive substances

Product Code	Nominal Diameter mm	Approx Flange OD mm	Total Height mm	Quantity Per Case	Price / Piece ₹
3085041	100	153	173	1	17190.00
3085042	150	213	205	1	22080.00
3085043	200	272	272	1	24130.00
3085044	250	333	323	1	34775.00
3085045	300	395	344	1	39010.00

Spare cover, porcelain plate and stopcock available on request

Steps for Assembling Vacuum Desiccator	STEP 1	STEP 2	STEP 3	STEP 4	STEP 5
	Remove the different parts supplied with the Desiccator <ul style="list-style-type: none"> • Bottom • Lid • Porcelain plate • Stop cock 	Place the porcelain plate in the bottom part of the desiccator	Place the lid over it	Remove the blue knob from the lid and fit the stopcock in blue knob	Screw the blue knob along with the stopcock on the lid Connect the desiccator to a vacuum source (pressure 1 bar) with a rubber tube.

Dishes

BOROSIL[®] brand Dishes are designed to fulfil your wide-ranging needs - Crystallizing, Evaporating, Drying, Storing, Petri dishes for culture, assay and micro-biological works. All **BOROSIL**[®] brand Dishes are safe, durable and economical.

BOROSIL[®] brand Dishes are inert, can be sterilised and remain clear even after repeated use and washing. With each subsequent use, the cost per Dish decreases.

Made from 3.3 Low Expansion
Borosilicate Glass



3140 - CRYSTALLIZING DISHES

- Reinforced and fire-polished rims reduce chipping
- Large labelling field for easy marking
- Very high resistance to chemicals and thermal shocks
- Ideal for crystallization and in hot/ice baths

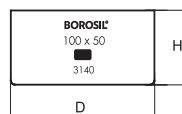

Product Code	Approx O.D. x Height mm	Approx Overflow Capacity ml	Quantity Per Case	Price / Piece ₹
3140077	100 x 50	330	10	465.00
3140081	150 x 75	1150	10	810.00
3140086	190 x 100	2500	4	1345.00

3170 - DRYING TRAYS

- Made with a heavy wall, withstand hot air or steam sterilization
- Facilitates paper chromatography
- Dimensions are approximate, representing the inside

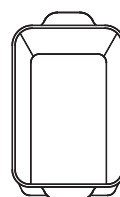

Product Code	Approx Dimension mm	Approx Capacity ml	Quantity Per Case	Price / Piece ₹
3170044	320 x 180 x 51	1500	5	585.00
3170043	350 x 200 x 58	2400	5	815.00
3170042	386 x 217 x 63	3000	5	1135.00
3170041	404 x 257 x 61	3500	5	1360.00

3180 - FLAT BOTTOM EVAPORATING DISHES

With Spout

- Withstands repeated sterilisation (Wet or dry)
- Designed with a spout to facilitate clean pouring
- Very high resistance to chemicals and thermal shocks
- Beaded edge give greater mechanical strength
- Ideal for evaporating solvents in hot/ice baths

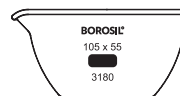

Product Code	Approx Dimension mm	Approx Overflow Capacity ml	Quantity Per Case	Price / Piece ₹
3180072	80 x 45	130	10	400.00
3180078	105 x 55	290	10	560.00
3180081	150 x 80	855	10	1050.00
3180087	200 x 100	1790	8	1930.00

Distilling Apparatus

Most of the distillation equipment required in an average laboratory can be constructed using standard Borosil components. Distillation assemblies for specific applications are available as complete units, as listed herein.

Made from 3.3 Low Expansion Borosilicate Glass



3340-DISTILLING APPARATUS

With Graham Condenser And Interchangeable Joints

- Ideal for determining nitrogen in organic compounds
- Digestion and distillation stages can be performed in this apparatus
- The inlet tube allows permanganate solution to be introduced after distillation
- Large labelling field for easy marking

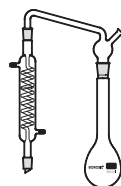

Product Code	Capacity ml	Quantity Per Case	Price / Piece ₹
3340024	500	2 Set	3345.00

Spare parts available on request

Distilling Apparatus

3360-DISTILLING APPARATUS

With Graham Condenser, Interchangeable Joints and Stopper

- Ideal for batch production of high purity distilled water
- General purpose Batch Distillation Assembly equipped
- with an interchangeable stoppered neck that facilitates addition
- The Flask has a flat base with a delivery tube on the side

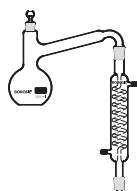

Product Code	Capacity ml	Condenser Jacket mm	Inter-changeable Joint	Quantity Per Case	Price / Piece ₹
3360024	500	200	19 / 26	2 Set	3350.00

Spare parts available on request

3380- DISTILLING APPARATUS

with Friedrichs Condenser, Interchangeable Joint and Stopper

- Ideal for batch production of high purity distilled water
- With Friedrich's Spiral Condenser for higher distillation rates
- General purpose Batch Distillation Assembly equipped with an interchangeable stoppered neck that facilitates addition
- The Flask has a flat base with a delivery tube on the side

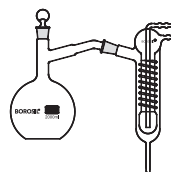

Product Code	Capacity ml	Interchange-able Joint	Quantity Per Case	Price / Piece ₹
3380030	2000	24 / 29	1 Set	4140.00

Spare parts available on request

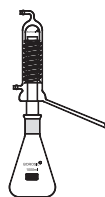

3440-DISTILLING APPARATUS with Friedrichs Condenser, Interchangeable Joint

- Compact
- A compact distillation assembly with specially designed Friedrich's Condensers
- This Condenser is designed with vapour tubing rising at
- A 1000 ml Erlenmeyer Flask is provided with an interchangeable 34/35 joint

Product Code	Capacity ml	Interchangeable Joint	Quantity Per Case	Price / Piece ₹
3440029	1000	34 / 35	2 Set	4025.00
Spare parts available on request				



3450-ESSENTIAL OIL DETERMINATION APPARATUS (Clevenger Apparatus), As per IS 1797

- Ideal for estimation of volatile oil that is heavier than water
- Supplied with a 5 ml Receiver with stopcock, an Oil Separator Tube, a condenser and 1000 ml flask

Product Code	Capacity ml	Quantity Per Case	Price / Piece ₹
3450029	1000	1 Set	7705.00
3450030	2000	1 Set	On request
3450033	5000	1 Set	On request
3450038	10000	1 Set	On request
3450040	20000	1 Set	On request
Spare parts available on request			

3451-ESSENTIAL OIL DETERMINATION APPARATUS

(Clevenger Apparatus)

- Ideal for estimation of volatile oil that is lighter than water
- Supplied with a 5 ml Receiver with stopcock, an Oil Separator Tube, a condenser and 1000 ml flask



Product Code	Capacity ml	Quantity Per Case	Price / Piece ₹
3451029	1000	1 Set	7705.00
3451030	2000	1 Set	On request
3451033	5000	1 Set	On request
3451038	10000	1 Set	On request
3451040	20000	1 Set	On request

Spare parts available on request



Distilling Apparatus

3452 - ALCOHOL DISTILLATION UNIT

- Ideal for distilling alcohol in the laboratory to produce the purest grade
- Thorpe's revenue still for purification of ethyl alcohol popularly used in pharmaceutical industries



Product Code	Capacity ml	Quantity Per Case	Price / Piece ₹
3452029	1000	1 Set	9580.00

Spare parts available on request



ON DEMAND

Water Distillation Units

Distillation is the most reliable and cost effective method of generating pure water for laboratory uses like reagents, buffer preparations, pH solutions, rinsing, media preparation, in baths, autoclaves etc.

Distillation generates water free of organic, inorganic impurities from feed water without the need to spend large sums on membranes, resins or filters.

Borosil's ON DEMAND Automatic distillation units empowers the user to set the demand for a set volume of pure water. The unit operates automatically to deliver the set volume and turns itself off.

A system prompted step by step guide assists the user in cleaning the unit for an uninterrupted operation. Safety features for auto cut-off in case of water supply failure or boiler overheating.

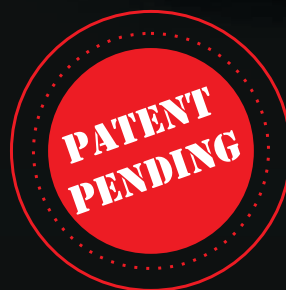

SINGLE DISTILLATION GLASS UNIT

Output Water: Typical Values with potable drinking water as input

Conductivity (S/cm)	< 3 X 10 ⁻⁶
Biological Activity	Pyrogen Free

Technical Details

Model No	SDU150	SDU250	SDU400
Water output	1.5LPH	2.5LPH	4.0LPH
Dimensions (W X D X H)	(650 X 255X 460) mm	(650 X 255X 460) mm	(650 X 255X 460) mm
Weight in Kg	Approx 15Kg	Approx 18Kg	Approx 20Kg

Ordering Information

Model No	Old Model No	Product Code	LPH	Type	Stage	Price/ Unit
SDU150	3361041 with 3366141	BLFRSDU15000000000	1.5	On demand, Automatic	Single Stage	35,500.00
SDU250	3361042 with 3366142	BLFRSDU25000000000	2.5	On demand, Automatic	Single Stage	49,500.00
SDU400	3361032 with 3366132	BLFRSDU40000000000	4.0	On demand, Automatic	Single Stage	55,100.00
3361041	3361041	3361041	1.5	Manual	Single Stage	21,480.00
3361042	3361042	3361042	2.5	Manual	Single Stage	36,450.00
3361032	3361032	3361032	4.0	Manual	Single Stage	42,250.00

DOUBLE DISTILLATION UNITS WITH GLASS BOILER & GLASS CONDENSER

Output Water: Typical Values with potable drinking water as input

Conductivity (S/cm)	< 1 X 10 ⁻⁶
Biological Activity	Pyrogen Free

Technical Details

Model No	SDU150	SDU250	SDU400
Water output	1.5LPH	2.5LPH	4.0LPH
Dimensions (W X D X H) mm	(650 X 255X 460)	(650 X 255X 460)	(650 X 255X 460)
Weight in Kg	Approx 15Kg	Approx 18Kg	Approx 20Kg

Ordering Information

Model No	Old Model No	Product Code	LPH	Type	Stage	Price/ Unit
DDU150	3361041 with 3366241	BLFRDDU15000000000	1.5	On demand, Automatic	Two Stage	56,500.00
DDU250	3361042 with 3366242	BLFRDDU25000000000	2.5	On demand, Automatic	Two Stage	91,100.00
DDU400	3361032 with 3366232	BLFRDDU40000000000	4.0	On demand, Automatic	Two Stage	99,100.00
3362041	3362041	3362041	1.5	Manual	Two Stage	41,750.00
3362042	3362042	3362042	2.5	Manual	Two Stage	76,750.00
3362032	3362032	3362032	4.0	Manual	Two Stage	85,500.00

HS 8419090

Mono Quartz Distillation Unit

The supply of pyrogen-free distilled water is a basic requisite for research, analytical and industrial laboratories. Distilled water from metallic units does not meet the required standards. Moreover, such units are bulky and cumbersome.

Borosil Mono Quartz Distillers are very compact and are constructed of high purity quartz, thereby meeting the standard of analytical laboratories, where the purity of distilled water that is free from metallic ions and bacteria, is the chief criterion.

The boiler is made of high purity quartz and the condenser is made of borosilicate/quartz material. The built-in heater ensures minimum loss of heat, and production of distilled water in 2 to 3 minutes. The Unit is mounted on a powder-coated metal stand with electrical connections, and is easy to dismantle and assemble. The fibre glass insulated wire and silicone rubber boot resist high temperatures.



3363 - MONO QUARTZ DISTILLATION UNIT

Panel Mounted with Quartz Boiler & Borosilicate Condenser, Vertical Model

Particulars/ Model	3363		
	2.5	5	10
Dist. Water output cap (Approx) (Ltr/hr)	2.5	5	10
Minimum cooling water requirement (Ltr/ min)	1	2	2.5
Total Power consumed (Kw)	2.2	4.4	8.8
Conductivity (S/ cm) *	<3 x 10-6	<3 x 10-6	<3 x 10-6
Voltage (V)	230 - 250 V	230 - 250 V	230 - 250 V
Biological Activity	Pyrogen Free	Pyrogen Free	Pyrogen Free
Boiler	Quartz	Quartz	Quartz
Condenser	Borosilicate	Borosilicate	Borosilicate
HSN Code	84194090	84194090	84194090
Product code	3363042	3363033	3363038
Price / Unit - ₹	37,800.00	70,650.00	1,60,650.00

* Inlet water TDS < 100 ppm

STANDARD ACCESSORIES FOR CAT NO. 3363

Product Code	For Cat No.	Output Capacity (Lt/Hr)	Description	HSN Code	Price / Piece ₹
3366342	3363	2.5	Distillation Appartus Power Supply (DAPS)	85362029	12,970.00
3366333	3363	5	Distillation Appartus Power Supply (DAPS)	85362090	14,380.00
3366338	3363	10	Distillation Appartus Power Supply (DAPS)	85362090	26,700.00

SPARES FOR DISTILLATION UNIT FOR CAT NO. 3363

Product Code	For Cat No.	Output Capacity (Lt/Hr)	Description	HSN Code	Price / Piece ₹
363012	3363	2.5	Quartz Boiler	84194090	27,560.00
362022	3363	2.5	Borosilicate Condenser	70179090	4,890.00
363032	3363	5	Quartz Boiler	84194090	50,720.00
0363S00	3363	5	Borosilicate Condenser	70179090	16,750.00
0363S02	3363	10	Quartz Boiler	84194090	88,920.00
0363S03	3363	10	Borosilicate Condenser	70179090	33,880.00

3364 - MONO QUARTZ DISTILLATION UNIT

Panel Mounted with Quartz Boiler And Quartz Condenser,
Vertical Model

Particulars/ Model	3364	
Dist. Water output cap (Approx) (Ltr/hr)	2.5	5
Minimum cooling water requirement (Ltr/ min)	1	2
Total Power consumed (Kw)	2.2	4.4
Conductivity (S/ cm) *	<2 x 10-6	<2 x 10-6
Voltage (V)	230 - 250 V	230 - 250 V
Biological Activity	Pyrogen Free	Pyrogen Free
Boiler	Quartz	Quartz
Condenser	Quartz	Quartz
HSN Code	84194050	84194050
Product code	3364042	3364033
Price / Unit - ₹	64,050.00	1,22,850.00

* Inlet water TDS < 100 ppm



Distilling Apparatus

STANDARD ACCESSORIES FOR CAT NO. 3364

Product Code	For Cat No.	Output Capacity (Lt/Hr)	Description	HSN Code	Price / Piece ₹
3366442	3364	2.5	Distillation Apparatus Power Supply (DAPS)	84194090	12,970.00
3366433	3364	5	Distillation Apparatus Power Supply (DAPS)	84194090	14,360.00

SPARES FOR DISTILLATION UNIT FOR CAT NO. 3364

Product Code	For Cat No.	Output Capacity (Lt/Hr)	Description	HSN Code	Price / Piece ₹
363012	3364	2.5	Quartz Boiler	84194090	27,560.00
364023	3364	2.5	Quartz Condenser	70171000	25,580.00
363032	3364	5	Quartz Boiler	84194090	50,720.00
0364S01	3364	5	Quartz Condenser	70171000	58,800.00

All Quartz Double Distillation Unit

The unit consist of Primary Boiler with built-in heater. The Primary Boiler has a 'O' ring groove at the top on which a silicone 'O' Ring sits. The Secondary Boiler with Condenser is mounted on the Primary Boiler.

A Double wall Condenser ensures separate condensation of vapor coming from the two Boilers using a single cooling circuit.

The whole unit is mounted on powder coated stand with Electrical Terminals for easy connection either to the mains or DAPS (Distillation Apparatus Power Supply). The bottom outlet is connected to a 'T' joint of which limb is connected by a rubber tubing & pinch cock for cleaning sediments in Primary Boiler by acid wash and other limb to the water leveller of 'DAPS'.

- Demountable Model - Primary Boiler easy to dismantle
- Innovative Design - "O" Ring with Primary Boiler
- New Condenser Unit - Water inlet & outlet at top of the unit



3365 - ALL QUARTZ DOUBLE DISTILLATION UNIT

Demountable Boiler Panel Series, Vertical Model

Automatic Single Distillation Glass Unit

Particulars/ Model	3365		
	1.5	2.5	5
Dist. Water output cap (Approx) (Ltr/hr)	1.5	2.5	5
Minimum cooling water requirement (Ltr/ min)	1	2	2.5
Total Power consumed (Kw)	3	4.4	8.8
Conductivity (S/ cm) *	<1 x 10 ⁻⁶	<1 x 10 ⁻⁶	<1 x 10 ⁻⁶
Voltage (V)	230 - 250 V	230 - 250 V	230 - 250 V
Biological Activity	Pyrogen Free	Pyrogen Free	Pyrogen Free
Boiler	Quartz	Quartz	Quartz
Condenser	Quartz	Quartz	Quartz
HSN Code	84194090	84194090	84194090
Product code	3365041	3365042	3365033
Price / Unit - ₹	95,550.00	1,92,150.00	3,50,700.00

* Inlet water TDS < 100 ppm

Note : Because of difficulties associated with measurement of the pH value of high purity water and the doubtful significance values obtained, limits for the pH value of grade 1 & grade 2 water have not been specified

STANDARD ACCESSORIES FOR CAT NO. 3365

Product Code	For Cat No.	Output Capacity (Lt/Hr)	Description	HSN Code	Price / Piece ₹
3366541	3365	1.5	Distillation Apparatus Power Supply (DAPS)	85362090	13,670.00
3366542	3365	2.5	Distillation Apparatus Power Supply (DAPS)	85362090	14,360.00
3366533	3365	5	Distillation Apparatus Power Supply (DAPS)	85362090	27,090.00

SPARES FOR DISTILLATION UNIT FOR CAT NO. 3365

Product Code	For Cat No.	Output Capacity (Lt/Hr)	Description	HSN Code	Price / Piece ₹
362013	3365	1.5	Primary Boiler	84194090	26,580.00
362015	3365	1.5	Secondary Boiler	84194090	1,01,580.00
362063	3365	1.5	Receiving Adapter with spring	70179090	1,810.00
362014	3365	2.5	Primary Boiler	84194090	33,140.00
362016	3365	2.5	Secondary Boiler	84194090	1,41,330.00
362063	3365	2.5	Receiving Adapter with spring	70179090	1,810.00
0362504	3365	5	Primary Boiler	84194090	52,210.00
0363505	3365	5	Secondary Boiler	84194090	2,73,100.00
362063	3365	5	Receiving Adapter with spring	70179090	1,810.00
362052	3365		Silicon 'O' Ring	40091100	550.00

3370 - CABINET STILL UNIT

- Designed with an inbuilt level sensor and cut-off device in case the water in the Boiler drops below the desired level
- Cleaning is easier due to the integral funnel that facilitates addition of acid to the Boiler and rota-flow stopcock for draining out sediments
- The unique design of the Condenser ensures effective cooling and low distillate temperature
- The acrylic safety screen and cabinet lid are removable, enabling easy access to the glassware components



Particulars/ Model	3372
Dist. Water output cap (Approx) (Ltr/hr)	2.5
Minimum cooling water requirement (Ltr/ min)	2
Total Power consumed (Kw)	1
Conductivity (S/ cm)*	2.2
Distillation Temp (0C)	<2 x 10-6
Voltage (V)	230 - 250 V
Biological Activity	Pyrogen Free
Heater	Quartz
Boiler	Borosilicate Glass
Condenser	Borosilicate Glass
HSN Code	84194090
Product code	3370032
Price / Unit - ₹	77,700.00

* Inlet water TDS < 100 ppm

Product Code	Cat No.	Output Capacity (Lt/Hr)	HSN Code	Price / Piece ₹
3370S01	3370	Borosilicate Boiler With Leveller	70179090	18,230.00
3370S02	3370	Borosilicate Condenser	70179090	13,680.00
3370S03	3370	Quartz B - 50 Heater	84194090	18,230.00
3370S04	3370	DAPS	85362090	24,870.00



Eco MS : All Glass Single Distillation System

- Single distilled
- With acid addition funnel & drain stopcock
- Unique condenser design for maximum output
- Safety thermostat to prevent over heating in the event of water supply failure

Model	Eco MS
Output per hour	4 Lit / Hr
Typical pH	5.0 - 6.5
Conductivity	3.0 - 4.0
Pyrogen Content*	Pyrogen free
Water Supply	1 Lit / minute, 3 -1 00 psi (20 - 700kPa)
Electricity Supply	220 - 240 V, 50 - 60 Hz, Single Phase
Power Requirement	3 kw
Dimensions (W x D x H)	500 x 150 x 450 mm
Product Code	100336104LG00M
Price	On request

* Inlet water TDS < 100 ppm



3369 - SILICONE TUBING FOR DISTILLATION UNIT & LABORATORY APPLICATION

*Heat Resistance Temperature Range : -400C To +2050C

The technical data given by Borosil must be used as a guide only. Borosil does not guarantee the accuracy of information and is not responsible for its end use.

Silicone tubing is used for laboratory and industrial applications only. It should not be used for implants , human reproductive system and other medical applications.

336900 - 8mm x 12mm is used for 3361-1.5, 3362-1.5, 3363-2.5 series

3369004 - 10mm x 14mm is used for 3361-4l, 3362-4l, 3364-2.5l, 5l, 3365-1.5l,2.5l,5l, 3363-5l,10l.

Product Code	Size mm	Quantity per case	HSN Code	Price for 10 Meter ₹ in mtr
3369001	4 mm ID x 7 mm OD	10	40091100	1,530.00
3369002	6 mm ID x 9 mm OD	10	40091100	1,990.00
3369003	8 mm ID x 12 mm OD	10	40091100	4,160.00
3369004	10 mm ID x 14 mm OD	10	40091100	5,220.00



COD DIGESTION UNIT

- Aluminium block heating unit with provision to keep 8 or 15 samples at a time in 40 mm diameter reaction vessels.
- Insulated heater block body to withstand acidic attacks
- Temperature overheat sensors
- End of cycle audible buzzer
- Continuous graphical monitoring of time & temperature
- Data Print mode available for documentation.
- Editable presets for user convenience

Model No	COD082	COD152
Reflux Type	Open	
Positions	08 Position	15 Position
Capacity	250 ml X 08 tubes	250 ml X 12 tubes
Heating Block	Aluminium	
Temperature Range	Ambient to 180°C	
Temperature Accuracy	±1°C	
Display	Graphic LCD	
Graphical representation of time and temp	Yes	
Two point factory calibration	Yes	
PID autotune	Yes	
User presets	Yes	
Process Timer	0-999 min	
Temperature Control	Yes with Set value and Present value	
Time Control	Yes with Set value and Present value	
Connectivity to Printer	Yes (upgradeable)	
Connectivity to USB	Yes (upgradeable)	
Power consumptions	1400W	1800 W
Current Consumption	6 A	8 A
Unit External Dimensions (WxDxH)	(414 x 414 x 283) mm	(414 x 427 x 283) mm
HSN Code	84194090	
Ordering Code	BLFACOD08200000000	BLFACOD15200000000
Price/ unit	On request	

ACCESSORIES

Product Code	Description	Pack Size	List Price
BLMACND100CODSAC00	COD air condensors	5	On request
BLMATUB100CODSGT20	COD digestion vessels	5	On request



SOX065

FAT DETERMINATION APPARATUS : SOXHLET EXTRACTION

- Individual rotary knob for precise setting of temperature and time
- Large character digital display for high visibility.
- SS 304 top plate.
- Chemical and heat resistant body.
- Mounts for safely holding the glass parts.

Model Name	SOX012	SOX015	SOX042	SOX045	SOX062	SOX065
Position	1		4		6	
Extractor capacity (ml)	250	500	250	500	250	500
Flask Capacity (ml)	100	200	100	200	100	200
Temperature Accuracy	±1°C					
Temperature Uniformity	±15°C					
Plate Temperature	Upto to 320°C					
Safe temperature setting	Yes					
Liquid Temperature	95°C for normal water at 560 m above mean sea level					
Display Timer	1-999 min					
Dimension (W X D X H) mm	200 X 300 X 800		750 X 300 X 800		1050 X 300 X 800	
Weight (Kgs)	7		12		15	
Power (W)	400		1600		2400	
HSN Code	84194090					
Ordering code	BLFRSOX01200000000	BLFRSOX01500000000	BLFRSOX04200000000	BLFRSOX04500000000	BLFRSOX06200000000	BLFRSOX06500000000
Price/ Unit	On request	On request	On request	On request	On request	On request

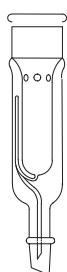
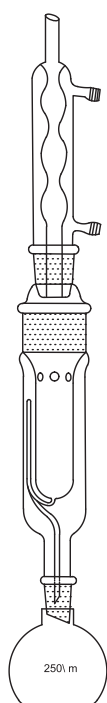

Extractor 100ml

SOXHLET HOT EXTRACTION

The new jacketed design protects the siphon from breakage and permits the extraction at the boiling point of the solvent. During extraction process the inner cup is enveloped in ascending solvent vapors.

The hot extraction process reduces time considerably. Compared with condensed solvent in the classical soxhlet method where the solvent temperature is below the boiling point, this method is faster because analytes are more soluble in hot vapor than in cold to warm solvent.

It not only reduces time of extraction, but also reduces power and is very easy in handling

Product	Description	HSN Code	Price / Piece ₹
100JHE000000	Jacketed Hot Extraction Unit with 250ml flat bottom flask	70179090	6,762.00
100JHESGE100	Spare Extractor 100ml	70179090	4000.00

*Till stock lasts

High Performance Laboratory Water & Oil Bath



EFFICIENT



SECURE



EASY



SCAN TO
KNOW MORE



Manufactured
by
BOROSIL®
TECHNOLOGIES

Extractors

Liquid Solid Extraction involves the elution of a solid sample with pure solvent vapour. The sample is held in the Extractor body either directly or in a thimble. The siphoning type of Soxhlet Extractor finds the widest application in laboratory work. Borosil Soxhlet Extraction Apparatus is available in six sizes. The component parts of the apparatus are provided with interchangeable joints for greater flexibility.



3740 - SOXHLET FOR EXTRACTION APPARATUS

- With interchangeable joints
- Complies with IS 10640
- Designed with a bulb in the siphon tube near the top, to aid the siphoning action
- The vapour tube also protects the siphon tube from accidental damage

Product Code	Capacity ml	Interchangeable Joints		Quantity Per Case	Price / Piece ₹
		Socket	Cone		
3740013	60	34 / 35	24 / 29	5	810.00
3740016	100	40 / 38	24 / 29	5	1145.00
3740020	200	50 / 42	24 / 29	5	1380.00

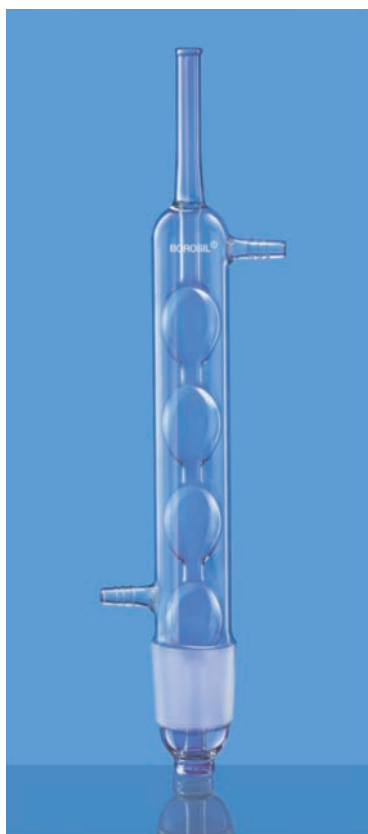

3741 - CONDENSER FOR EXTRACTION APPARATUS

- Greater surface area than the Liebig Condenser owing to a series of bulbs, resulting in higher cooling capacity
- Ideal for laboratory scale refluxing

Product Code	Capacity ml	Interchangeable Joints Cone	Quantity Per Case	Price / Piece ₹
3741013	Small	34 / 35	5	660.00
3741016	Medium	40 / 38	5	825.00
3741020	Large	50 / 42	5	1190.00

3840 - SOXHLET EXTRACTION APPARATUS SET

- With Interchangeable Joints
- Complies with IS 10640
- Used for separation of the extract from the liquid or solid
- Greater surface area than the Liebig Condenser owing to a series of bulbs, resulting in higher cooling capacity
- This method enables effective separation, with relatively small quantities

Product Code	Capacity ml	Flask Size ml	Quantity Per Case	Price / Piece ₹
3840013	60	150	1	1680.00
3840016	100	250	1	1980.00
3840020	200	500	1	3260.00
3840024	500*	2000	1	11815.00
3840029	1000*	3000	1	17650.00
3840030	2000*	5000	1	29800.00

Spares are available on request

For flask refer Product Code 4100

* Extractor Supplied are with double surface condenser for higher cooling capacity & flange type soxhlet extractors

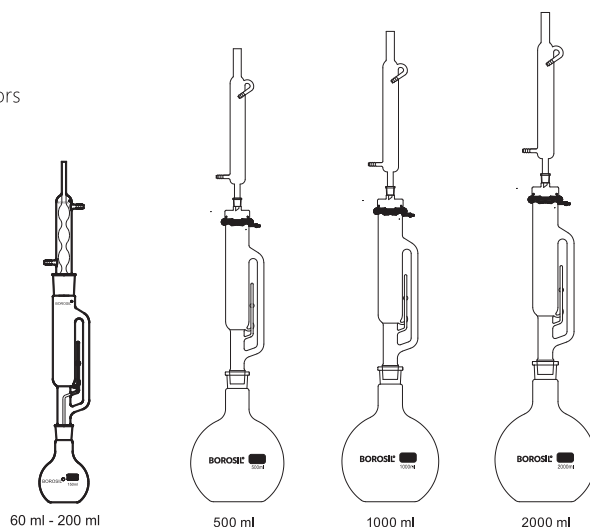

60 ml - 200 ml

500 ml

1000 ml

2000 ml



Extractors

LABQUEST
BY BOROSIL®

Controlled Heating Mantles



SAFE



INTELLIGENT



ACCURATE



For more details please refer page no. 250

BOROSIL®

an ISO 9001: 2015 certified company | PRICES EXCLUSIVE OF TAXES | For products listed on this page use HSN code 70179090

129

Flasks

All laboratories need Flasks of different types. **BOROSIL** offers a wide range of Flasks for a variety of applications such as boiling, culture, distilling, Erlenmeyer, Filtering, Iodine and Kjeldahl. Choose one to suit your needs.

BOROSIL[®] brand Flasks are designed to deliver the best combination of thermal shock resistance, physical strength and resistance to chemical attack. They are made so as to withstand the demands of the modern laboratory. Flasks with interchangeable joints are particularly suitable for all glass apparatus assemblies.

BOROSIL offers the interchangeable joints most commonly specified for a particular capacity. Tube Adaptors Category Nos. 8800 and 8820 can be used to connect the Flask with a particular size joint to any other apparatus having a different size joint.

Made from 3.3 Low Expansion Borosilicate Glass



4060 - FLAT BOTTOM FLASK

Narrow Mouth

- Complies with IS 1381 (Part - I), ISO 1773
- Uniform wall thickness distribution makes these flasks ideal for heating
- All sizes have a durable matt-finished enamelled area for marking

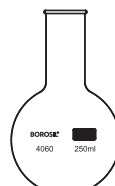

Product Code	Capacity ml	Approx O.D. x Height mm	Approx Neck O.D. mm	Quantity Per Case	Price / Piece ₹
4060009	25**	42 x 90	20	50	95.00
4060012	50	51 x 90	26	50	110.00
4060016	100	64 x 105	26	80	120.00
4060018	150**	75 x 132	28	10	130.00
4060021	250	85 x 140	34	80	140.00
4060022	*300**	88 x 160	24	20	195.00
4060024	500	105 x 165	34	40	230.00
4060029	1000	131 x 190	42	20	335.00
4060030	2000	166 x 230	50	2	640.00
4060031	3000	186 x 300	50	4	1735.00
4060033	5000	224 x 320	58	2	2840.00
4060034	6000	236 x 315	65	1	4100.00
4060038	10000	279 x 360	65	1	6620.00
4060040	20000	350 x 495	78	1	11020.00

* Suitable for use in Polenske Apparatus

** Not covered in standards



Flasks

4100 - FLAT BOTTOM FLASK

Narrow Mouth, Short Neck With I/C Joint

- Uniform wall thickness distribution makes these Flasks ideal for heating
- All sizes have a durable matt-finished enamelled area for marking
- Equipped with interchangeable joint
- The flat base ensures that the Flask can be placed down even without the supporting ring



Product Code	Capacity ml	Interchangeable Joint	Approx Height mm	Quantity Per Case	Price / Piece ₹
4100018	150	24 / 29	115	5	210.00
4100021	250	24 / 29	130	5	225.00
4100024	500	24 / 29	160	5	320.00
4100029	1000*	34 / 35	288	2	420.00
4100030	2000*	34 / 35	321	2	750.00
4100031	3000*	34 / 35	345	2	2050.00
4100033	5000*	34 / 35	381	2	3490.00

* These are specific flasks with long neck 34/35 joint used in jewellery manufacturers



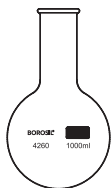

4260 - ROUND BOTTOM FLASK Narrow Mouth

- Complies with IS 1381 (Part I), ISO 1773
- Uniform wall thickness distribution makes these Flasks ideal for heating
- All sizes have a durable matt-finished enamelled area for marking

Product Code	Capacity ml	Approx O.D. x Height mm	Approx Neck O.D. mm	Quantity Per Case	Price / Piece ₹
4260009	25**	42 x 90	22	50	95.00
4260012	50	51 x 95	26	70	105.00
4260016	100	64 x 110	26	50	120.00
4260018	150**	75 x 137	28	10	130.00
4260021	250	85 x 143	34	80	130.00
4260024	500	105 x 168	34	40	230.00
4260029	1000	131 x 200	42	20	310.00
4260030	2000	166 x 240	51	2	690.00
4260031	3000	187 x 305	50	2	1700.00
4260033	5000	224 x 350	58	2	2805.00
4260034	6000	236 x 330	65	1	3665.00
4260038	10000	279 x 380	65	1	5860.00
4260040	20000	350 x 505	78	1	10980.00

** Not covered in standards

LABQUEST
BY **BOROSIL®**

Controlled Heating Mantles

SAFE

INTELLIGENT

ACCURATE

For more details please refer page no. 250

4380 - ROUND BOTTOM FLASK

Narrow Mouth, Short Neck With I/C Joint

- Uniform wall thickness distribution and the round - bottom shape make them ideal for heating
- Generally used in distillation and extraction processes
- Large labelling field



Flasks

Product Code	Capacity ml	Approx Height mm	Interchangeable Joint	Quantity Per Case	Price / Piece ₹
4380A05	5	60	14 / 23	10	180.00
4380A06	10	70	14 / 23	10	180.00
4380A09	25	80	14 / 23	10	180.00
4380B09	25	77	19 / 26	10	180.00
4380A12	50	95	14 / 23	5	180.00
4380B12	50	95	19 / 26	5	180.00
4380C12	50	95	24 / 29	5	180.00
4380D12	50	95	29 / 32	5	180.00
4380E12	50	95	34 / 35	5	180.00
4380A16	100	120	14 / 23	20	180.00
4380B16	100	120	19 / 26	20	180.00
4380C16	100	120	24 / 29	20	180.00
4380D16	100	120	29 / 32	20	180.00
4380E16	100	120	34 / 35	20	180.00
4380A21	250	140	14 / 23	20	230.00
4380B21	250	140	19 / 26	20	230.00
4380C21	250	140	24 / 29	20	230.00
4380D21	250	140	29 / 32	20	230.00
4380E21	250	140	34 / 35	20	230.00
4380A24	500	170	14 / 23	10	325.00
4380B24	500	170	19 / 26	10	325.00
4380C24	500	170	24 / 29	10	325.00
4380D24	500	170	29 / 32	10	325.00
4380E24	500	170	34 / 35	10	325.00
4380A29	1000	210	19 / 26	10	440.00
4380B29	1000	210	24 / 29	10	440.00
4380C29	1000	210	29 / 32	10	440.00
4380D29	1000	210	34 / 35	10	440.00
4380E29	1000	210	45 / 40	10	440.00
4380F29	1000	210	55 / 44	10	440.00
4380A30	2000	240	24 / 29	4	845.00
4380B30	2000	240	29 / 32	4	845.00
4380C30	2000	240	34 / 35	4	845.00
4380D30	2000	240	45 / 40	4	845.00
4380A31	3000	240	24 / 29	4	2380.00
4380B31	3000	265	29 / 32	4	2380.00
4380C31	3000	265	34 / 35	4	2380.00
4380D31	3000	265	45 / 40	4	2380.00
4380E31	3000	265	55 / 44	4	2380.00
4380A33	5000	300	24 / 29	2	3635.00
4380B33	5000	300	29 / 32	2	3635.00
4380C33	5000	300	34 / 35	2	3635.00
4380D33	5000	300	45 / 40	2	3635.00
4380E33	5000	300	55 / 44	2	3635.00
4380A38	10000	385	34 / 35	1	7340.00
4380B38	10000	385	45 / 40	1	7340.00
4380C38	10000	385	55 / 44	1	7340.00
4380A40	20000	435	55 / 44	1	12700.00



4381 - ROUND BOTTOM FLASK

2 Necks, Angular

- With Interchangeable Joints
- One neck is centred and vertical. The side neck is inclined at an angle of 20° to the vertical neck
- Uniform wall thickness distribution and the round-bottom shape make them ideal for heating
- The shape facilitates uniform heating
- Accessories, thermometer, column, dropping funnels, boiling capillaries, etc., can be fitted depending upon the application
- Generally used in distillation and extraction processes

Product Code	Capacity ml	Interchangeable Joint Size		Quantity Per Case	Price / Piece ₹
		Centre Neck	Side Neck		
4381A16	100	19 / 26	14 / 23	4	260.00
4381B16	100	24 / 29	14 / 23	4	260.00
4381C16	100	24 / 29	19 / 26	4	260.00
4381A21	250	24 / 29	14 / 23	4	345.00
4381B21	250	24 / 29	19 / 26	4	345.00
4381A24	500	24 / 29	14 / 23	4	500.00
4381B24	500	24 / 29	19 / 26	4	500.00
4381A29	1000	24 / 29	14 / 23	2	620.00
4381B29	1000	24 / 29	19 / 26	2	620.00
4381A30	2000	24 / 29	14 / 23	2	1100.00
4381B30	2000	24 / 29	19 / 26	2	1100.00
4381C30	2000	34 / 35	19 / 26	2	1100.00
4381A31	3000	34 / 35	19 / 26	2	2980.00
4381B31	3000	34 / 35	24 / 29	2	2980.00
4381A33	5000	34 / 35	19 / 26	1	4370.00
4381B33	5000	34 / 35	24 / 29	1	4370.00
4381A38	10000	34 / 35	24 / 29	1	7860.00
4381B38	10000	55 / 44	24 / 29	1	7860.00
4381A40	20000	55 / 44	24 / 29	1	13080.00

4382 - ROUND BOTTOM FLASK

2 Necks, Parallel

- With Interchangeable Joints
- Both the necks are vertical. One neck is centred, while the other is the side neck
- Uniform wall thickness distribution and the round-bottom shape make them ideal for heating
- The shape facilitates uniform heating
- Accessories, thermometer, column, dropping funnels, boiling capillaries, etc., can be fitted depending upon the application
- Generally used in distillation and extraction processes



Flasks

Product Code	Capacity ml	Interchangeable Joint Size		Quantity Per Case	Price / Piece ₹
		Centre Neck	Side Neck		
4382A16	100	19 / 26	14 / 23	4	260.00
4382B16	100	24 / 29	14 / 23	4	260.00
4382C16	100	24 / 29	19 / 26	4	260.00
4382A21	250	24 / 29	14 / 23	4	345.00
4382B21	250	24 / 29	19 / 26	4	345.00
4382A24	500	24 / 29	14 / 23	4	500.00
4382B24	500	24 / 29	19 / 26	4	500.00
4382A29	1000	24 / 29	14 / 23	2	620.00
4382B29	1000	24 / 29	19 / 26	2	620.00
4382A30	2000	24 / 29	14 / 23	2	1100.00
4382B30	2000	24 / 29	19 / 26	2	1100.00
4382C30	2000	34 / 35	19 / 26	2	1100.00
4382A31	3000	34 / 35	19 / 26	2	2980.00
4382B31	3000	34 / 35	24 / 29	2	2980.00
4382A33	5000	34 / 35	19 / 26	1	4370.00
4382B33	5000	34 / 35	24 / 29	1	4370.00
4382A38	10000	34 / 35	24 / 29	1	7860.00
4382B38	10000	55 / 44	24 / 29	1	7860.00
4382A40	20000	55 / 44	24 / 29	1	13080.00

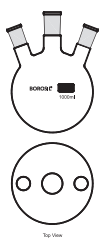

4383 - ROUND BOTTOM FLASK

3 Necks, Angular

- With Interchangeable Joints
- The centred neck is vertical. The two side necks are 180° apart and are inclined at an angle of 20° to the vertical neck
- Uniform wall thickness distribution and round-bottom shape make them ideal for heating
- The shape facilitates uniform heating
- Accessories, thermometer, column, dropping funnels, boiling capillaries, etc. can be fitted depending upon the application
- Generally used in distillation and extraction processes

Product Code	Capacity ml	Interchangeable Joint Size			Quantity Per Case	Price / Piece ₹
		Centre Neck	Side Neck	Side Neck		
4383A16	100	19 / 26	14 / 23	14 / 23	4	360.00
4383B16	100	14 / 23	14 / 23	14 / 23	4	360.00
4383C16	100	24 / 29	14 / 23	14 / 23	4	360.00
4383D16	100	24 / 29	19 / 26	19 / 26	4	360.00
4383A21	250	19 / 26	14 / 23	14 / 23	4	460.00
4383B21	250	19 / 26	19 / 26	19 / 26	4	460.00
4383C21	250	24 / 29	14 / 23	14 / 23	4	460.00
4383D21	250	24 / 29	19 / 26	19 / 26	4	460.00
4383A24	500	19 / 26	14 / 23	14 / 23	4	690.00
4383B24	500	19 / 26	19 / 26	19 / 26	4	690.00
4383C24	500	24 / 29	14 / 23	14 / 23	4	690.00
4383D24	500	24 / 29	19 / 26	19 / 26	4	690.00
4383A29	1000	24 / 29	14 / 23	14 / 23	2	850.00
4383B29	1000	24 / 29	19 / 26	19 / 26	2	850.00
4383C29	1000	34 / 35	24 / 29	24 / 29	2	850.00
4383D29	1000	34 / 35	19 / 26	19 / 26	2	850.00
4383A30	2000	24 / 29	14 / 23	14 / 23	2	1540.00
4383B30	2000	24 / 29	19 / 26	19 / 26	2	1540.00
4383C30	2000	34 / 35	19 / 26	19 / 26	2	1540.00
4383D30	2000	34 / 35	24 / 29	24 / 29	2	1540.00
4383A31	3000	34 / 35	19 / 26	19 / 26	2	3840.00
4383B31	3000	34 / 35	24 / 29	24 / 29	2	3840.00
4383A33	5000	34 / 35	19 / 26	19 / 26	1	5425.00
4383B33	5000	34 / 35	24 / 29	24 / 29	1	5425.00
4383C33	5000	45 / 40	24 / 29	24 / 29	1	5425.00
4383A38	10000	34 / 35	19 / 26	19 / 26	1	10475.00
4383B38	10000	34 / 35	24 / 29	24 / 29	1	10475.00
4383C38	10000	45 / 40	24 / 29	24 / 29	1	10475.00
4383A40	20000	55 / 44	24 / 29	24 / 29	1	15710.00

4384 - ROUND BOTTOM FLASK

3 Necks, Parallel

- With Interchangeable Joints
- All the three necks are vertical. The two side necks are 180° apart
- Uniform wall thickness distribution and round-bottom shape make them ideal for heating
- The shape facilitates uniform heating
- Accessories, thermometer, column, dropping funnels, boiling capillaries, etc. can be fitted depending upon the application
- Generally used in distillation and extraction processes



Flasks

Product Code	Capacity ml	Interchangeable Joint Size			Quantity Per Case	Price / Piece ₹
		Centre Neck	Side Neck	Side Neck		
4384A16	100	19 / 26	14 / 23	14 / 23	4	360.00
4384B16	100	14 / 23	14 / 23	14 / 23	4	360.00
4384C16	100	24 / 29	14 / 23	14 / 23	4	360.00
4384D16	100	24 / 29	19 / 26	19 / 26	4	360.00
4384A21	250	19 / 26	14 / 23	14 / 23	4	460.00
4384B21	250	19 / 26	19 / 26	19 / 26	4	460.00
4384C21	250	24 / 29	14 / 23	14 / 23	4	460.00
4384D21	250	24 / 29	19 / 26	19 / 26	4	460.00
4384A24	500	19 / 26	14 / 23	14 / 23	4	690.00
4384B24	500	19 / 26	19 / 26	19 / 26	4	690.00
4384C24	500	24 / 29	14 / 23	14 / 23	4	690.00
4384D24	500	24 / 29	19 / 26	19 / 26	4	690.00
4384A29	1000	24 / 29	14 / 23	14 / 23	2	850.00
4384B29	1000	24 / 29	19 / 29	19 / 26	2	850.00
4384C29	1000	34 / 35	24 / 29	24 / 29	2	850.00
4384D29	1000	34 / 35	19 / 26	19 / 26	2	850.00
4384A30	2000	24 / 29	14 / 23	14 / 23	2	1540.00
4384B30	2000	24 / 29	19 / 26	19 / 26	2	1540.00
4384C30	2000	34 / 35	19 / 26	19 / 26	2	1540.00
4384D30	2000	34 / 35	24 / 29	24 / 29	2	1540.00
4384A31	3000	34 / 35	19 / 26	19 / 26	2	3840.00
4384B31	3000	34 / 35	24 / 29	24 / 29	2	3840.00
4384A33	5000	34 / 35	19 / 26	19 / 26	1	5425.00
4384B33	5000	34 / 35	24 / 29	24 / 29	1	5425.00
4384C33	5000	45 / 40	24 / 29	24 / 29	1	5425.00
4384A38	10000	34 / 35	19 / 26	19 / 26	1	10475.00
4384B38	10000	34 / 35	24 / 29	24 / 29	1	10475.00
4384C38	10000	45 / 40	24 / 29	24 / 29	1	10475.00
4384A40	20000	55 / 44	24 / 29	24 / 29	1	15710.00



4385 - ROUND BOTTOM FLASK

4 Necks, Angular

- With Interchangeable Joints
- The centred neck is vertical. All the three side necks are inclined at an angle of 20° to the vertical neck
- The two side necks are 180° apart, and a third side neck is at 90° from the other two necks
- Uniform wall thickness distribution and round-bottom shape make them ideal for heating
- The shape facilitates uniform heating
- Accessories, thermometer, column, dropping funnels, boiling capillaries, etc. can be fitted depending upon the application
- Generally used in distillation and extraction processes

Product Code	Capacity ml	Interchangeable Joint Size		Quantity Per Case	Price / Piece ₹
		Centre Neck	Side Neck		
4385A12	50	24 / 29	24 / 29	4	510.00
4385A16	100	24 / 29	14 / 23	4	585.00
4385B16	100	24 / 29	19 / 26	4	585.00
4385A21	250	24 / 29	14 / 23	4	705.00
4385B21	250	24 / 29	19 / 26	4	705.00
4385A24	500	24 / 29	14 / 23	4	1005.00
4385B24	500	24 / 29	19 / 26	4	1005.00
4385C24	500	24 / 29	24 / 29	4	1005.00
4385D24	500	34 / 35	24 / 29	4	1005.00
4385A29	1000	24 / 29	14 / 23	2	1245.00
4385B29	1000	24 / 29	19 / 26	2	1245.00
4385C29	1000	24 / 29	24 / 29	2	1245.00
4385D29	1000	34 / 35	24 / 29	2	1245.00
4385A30	2000	24 / 29	14 / 23	2	2070.00
4385B30	2000	24 / 29	19 / 26	2	2070.00
4385C30	2000	34 / 35	19 / 26	2	2070.00
4385D30	2000	34 / 35	24 / 29	2	2070.00
4385A31	3000	34 / 35	19 / 26	2	4820.00
4385B31	3000	34 / 35	24 / 29	2	4820.00
4385A33	5000	34 / 35	19 / 26	1	6610.00
4385B33	5000	34 / 35	24 / 29	1	6610.00
4385A38	10000	55 / 44	24 / 29	1	11830.00
4385B38	10000	34 / 35	24 / 29	1	11830.00
4385A40	20000	55 / 44	24 / 29	1	17350.00

4386 - ROUND BOTTOM FLASK

4 Necks, Parallel

- With Interchangeable Joints
- All the four necks are vertical. The two side necks are 180° apart and the third neck is at 90° from the other two necks
- Four Necks, Centre Neck and Three Parallel Side Neck, with Interchangeable Joints
- Uniform wall thickness distribution and the round-bottom shape make them ideal for heating
- The shape facilitates uniform heating
- Accessories, thermometer, column, dropping funnels, boiling capillaries, etc. can be fitted depending upon the application
- Generally used in distillation and extraction processes



Product Code	Capacity ml	Interchangeable Joint Size		Quantity Per Case	Price / Piece ₹
		Centre Neck	Side Neck		
4386A12	50	24 / 29	24 / 29	4	510.00
4386A16	100	24 / 29	14 / 23	4	585.00
4386B16	100	24 / 29	19 / 26	4	585.00
4386A21	250	24 / 29	14 / 23	4	705.00
4386B21	250	24 / 29	19 / 26	4	705.00
4386A24	500	24 / 29	14 / 23	4	1005.00
4386B24	500	24 / 29	19 / 26	4	1005.00
4386C24	500	24 / 29	24 / 29	4	1005.00
4386D24	500	34 / 35	24 / 29	4	1005.00
4386A29	1000	24 / 29	14 / 23	2	1245.00
4386B29	1000	24 / 29	19 / 26	2	1245.00
4386C29	1000	24 / 29	24 / 29	2	1245.00
4386D29	1000	34 / 35	24 / 29	2	1245.00
4386A30	2000	24 / 29	14 / 23	2	2070.00
4386B30	2000	24 / 29	19 / 26	2	2070.00
4386C30	2000	34 / 35	19 / 26	2	2070.00
4386D30	2000	34 / 35	24 / 29	2	2070.00
4386A31	3000	34 / 35	19 / 26	2	4820.00
4386B31	3000	34 / 35	24 / 29	2	4820.00
4386A33	5000	34 / 35	19 / 26	1	6610.00
4386B33	5000	34 / 35	24 / 29	1	6610.00
4386A38	10000	55 / 44	24 / 29	1	11830.00
4386B38	10000	34 / 35	24 / 29	1	11830.00
4386A40	20000	55 / 44	24 / 29	1	17350.00



4315 - PEAR SHAPE FLASK

With I/C Joint

- The conical shape makes them ideal for small scale reaction
- Large labelling field

Product Code	Capacity ml	Interchangeable Joint Size	Quantity Per Case	Price / Piece ₹
4315005	5	10 / 19	10	150.00
4315105	5	14 / 23	10	150.00
4315006	10	10 / 19	10	160.00
4315106	10	14 / 23	10	160.00
4315009	25	14 / 23	5	180.00
4315012	50	14 / 23	10	200.00



4320 - ROTARY EVAPORATOR FLASK

With I/C Joint

- Rota Vapour Flasks are used along with Rotary Evaporators
- Ideal for heating sensitive solvent solute combinations
- Facilitate the extraction of key components like odour, oil, drugs, natural extract and fragrance

Product Code	Capacity ml	Interchangeable Joint Size	Quantity Per Case	Price / Piece ₹
4320112	50	24 / 29	2	965.00
4320012	50	29 / 32	2	1020.00
4320116	100	24 / 29	2	1530.00
4320016	100	29 / 32	2	1640.00
4320121	250	24 / 29	2	2305.00
4320021	250	29 / 32	2	2430.00
4320124	500	24 / 29	2	2640.00
4320024	500	29 / 32	2	2740.00
4320129	1000	24 / 29	2	4660.00
4320029	1000	29 / 32	2	4770.00
4320130	2000	24 / 29	2	6010.00
4320030	2000	29 / 32	2	6160.00

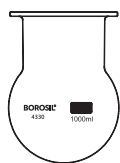

4330 - REACTION VESSEL FLASK

Wide Mouth With Flange

- These flasks have a spherical body with a neck of inner diameter 4 inches (approx 100 mm)
- The top is finely ground to ensure a leak-resistant fit with the cover

Product Code	Capacity ml	Approx Height mm	Quantity Per Case	Price / Piece ₹
4330029	1000	170	2	1700.00
4330030	2000	205	2	2310.00
4330033	5000	260	2	5060.00
4330038	10000	335	1	10680.00
4330040	20000	400	1	18380.00

4331 - LID FOR REACTION VESSEL FLASK

(Cat. No. 4330)

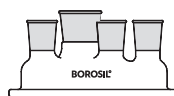

- Lids can be used with all of the above capacities of REACTION VESSEL FLASK (CAT. NO. 4330)

Product Code	Interchangeable Joint Size					Quantity Per Case	Price / Piece ₹
	Centre	Parallel	Side 50°	Side 10°	Side 15°		
4331Z97	19 / 26	19 / 26	24 / 29	19 / 26	-	2	3985.00
4331Z98	19 / 26	14 / 23	14 / 23	14 / 23	29 / 32	2	3985.00
4331Z99	29 / 32	14 / 23	14 / 23	14 / 23	29 / 32	2	3985.00



6947 - REACTION KETTLES ASSEMBLY

Resin Reaction

- The wide mouth enables easy access for cleaning the interior
- Flanges of the covers and base are finely ground to ensure a tight seal
- Equipped with interchangeable covers with four openings
- Designed for viscous reaction materials

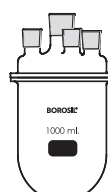

Product Code	Capacity ml	Body Dia mm	Height mm	Quantity Per Case Set	Price / Piece ₹
6947024	500	100	150	1	12140.00
6947029	1000	110	175	1	12660.00
6947030	2000	150	185	1	15435.00
6947032	4000	150	340	1	18555.00

The 500 ml and 1000 ml kettles have interchangeable covers with four openings to accommodate 24 / 29 interchangeable joints. Kettles of 2000 ml and 4000 ml capacity have interchangeable covers with openings to accommodate three 24 / 29 interchangeable joints and one 34 / 35 interchangeable joint.



6948 - BOTTOM FOR KETTLE REACTION ASSEMBLY

Only for Kettles Cat no. 6947

- The base has a wide mouth that enables easy access for cleaning the interior
- Flanges of the base are finely ground to ensure a tight seal



Product Code	Capacity ml	Quantity Per Case	Price / Piece ₹
6948024	500	2	5865.00
6948029	1000	2	6515.00
6948030	2000	2	8460.00
6948032	4000	2	12360.00



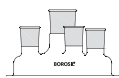

6949 - COVER FOR KETTLE REACTION ASSEMBLY

Only for Kettles Cat No. 6947

- The covers have openings with interchangeable joints to facilitate rapid assembly with Condensers and Stirrers
- Flanges of the covers are finely ground to ensure a tight seal

Product Code	Capacity ml	Quantity Per Case	Price / Piece ₹
6949041	500 / 1000	2	9330.00
6949042	2000 / 4000	2	10840.00

The 500 ml and 1000 ml kettles have interchangeable covers with four openings to accommodate 24 / 29 interchangeable joints. Kettles of 2000 ml and 4000 ml capacity have interchangeable covers with openings to accommodate three 24 / 29 interchangeable joints and one 34 / 35 interchangeable joint.

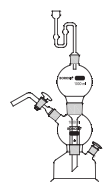

6550 - GAS GENERATOR APPARATUS (KIPPS)

- Used to produce common gases
- Simple to operate and assemble
- Quick charging

Product Code	Capacity ml	Quantity Per Case	Price / Piece ₹
6550024	500	1	9440.00
6550029	1000	1	12055.00

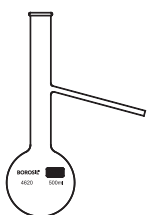

4620 - DISTILLING FLASK

With Side Arm

- Complies with IS 2620
- Uniform wall thickness distribution makes these Flasks ideal for heating
- Suitable for distillation process

Product Code	Capacity ml	Approx O.D. x Height mm	Approx Neck O.D. mm	Quantity Per Case	Price / Piece ₹
4620016	100	64 x 210	21	4	270.00
4620017	*125	70 x 215	21	4	265.00
4620021	250	85 x 230	25	4	440.00
4620024	500	105 x 250	28	4	515.00
4620029	1000	130 x 305	31	4	620.00

* Specification as per the Institute of Petroleum Standard No. IP 123/64

4621 - DISTILLING FLASK

With I/C Joint

- Distilling with I/C joint 19/26 as per ASTM D86



Product Code	Capacity ml	Approx O.D.xHeight mm	Approx Neck I. D.	Inter-changeable Joint	Quantity Per Case	Price / Piece ₹
4621017	125	70 x 218	19	19 / 26	20	455.00



5420 - KJELDAHL FLASK

- Designed with a tooled neck for greater strength and a better stopper fit
- These flasks are specially designed for nitrogen/protein determination as per the Kjeldahl method

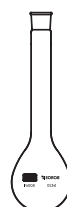

Product Code	Capacity ml	Approx O.D. x Height mm	Quantity Per Case	Price / Piece ₹
5420006	10	30 x 180	10	110.00
5420010	30	40 x 180	10	125.00
5420016	100	61 x 210	10	205.00
5420022	300	80 x 298	10	330.00
5420024	500	103 x 325	10	640.00
5420028	800	119 x 375	10	780.00



5430 - KJELDAHL FLASK

With I/C Joint

- Designed with a tooled neck for greater strength and better stopper fit
- These flasks are specially designed for nitrogen/protein determination as per Kjeldahl method.
- The flask with 500ml capacity is a part of Ammonia Distilling Apparatus Category No. 3340

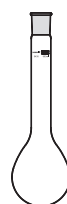

Product Code	Capacity ml	Approx O.D. x Height mm	Interchangeable Joint Size	Quantity Per Case	Price / Piece ₹
5430024	500	103 x 325	24 / 29	10	805.00
5430028	800	116 x 375	24 / 29	10	890.00



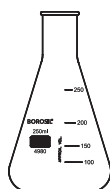

4980 - ERLLENMEYER (CONICAL) FLASK Narrow Mouth, With Rim

- Complies with IS 1381(Part I), DIN / ISO 1773
- Uniform wall thickness distribution makes these flasks ideal for heating
- The conical form makes them suitable for mixing liquids
- The easy-to-read scale and large labelling field facilitate easy marking
- Graduated from 25 ml to 5000 ml

Product Code	Capacity ml	Approx O.D. x Height mm	Approx Neck O.D. mm	Quantity Per Case	Price / Piece ₹
4980006	10*	37 x 60	15	30	85.00
4980009	25	42 x 75	22	40	90.00
4980012	50	51 x 90	22	100	90.00
4980016	100	64 x 105	22	100	95.00
4980017	125*	66 x 110	28	100	110.00
4980018	150*	72 x 124	28	100	115.00
4980021	250	85 x 145	34	40	140.00
4980024	500	105 x 180	34	40	200.00
4980029	1000	131 x 220	42	20	340.00
4980030	2000	166 x 280	52	20	590.00
4980031	3000	187 x 310	50	4	1590.00
4980033	5000	220 x 365	50	2	2615.00

25 ml to 5000 ml Graduated

* Not covered in standards

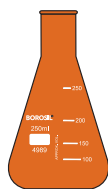

4989 - ERLLENMEYER (CONICAL) FLASK Narrow Mouth, With Rim, Amber

- Complies with IS 1381 (Part I), DIN / ISO 1773
- Uniform wall thickness distribution makes these flasks ideal for heating
- The conical form makes them suitable for mixing liquids
- The easy-to-read scale and large labelling field facilitate easy marking
- Graduated from 25 ml to 5000 ml
- Coloured in Amber to protect light-sensitive material
- The Amber colour is applied only to the external surface to prevent contamination with the testing material

Product Code	Capacity ml	Approx O.D. x Height mm	Approx Neck O.D. mm	Quantity Per Case	Price / Piece ₹
4989016	100	64 x 105	22	10	175.00
4989018	150*	72 x 124	28	10	210.00
4989021	250	85 x 145	34	10	250.00
4989024	500	105 x 180	34	10	405.00
4989029	1000	131 x 220	42	10	680.00

* Not covered in standards

5000 - ERLLENMEYER (CONICAL) FLASK

Narrow Mouth, With I/C Joint

- Complies with IS 1381(Part I), DIN / ISO 1773
- Equipped with interchangeable joints
- Uniform wall thickness distribution makes these flasks ideal for heating
- The conical form makes them suitable for mixing of liquids
- The easy-to-read scale and large labelling field facilitate easy marking



Product Code	Capacity ml	Interchangeable Joint	Quantity Per Case	Price / Piece ₹
5000009	25	14 / 23	10	170.00
5000012	50	19 / 26	10	180.00
5000016	100	24 / 29	10	210.00
5000021	250	24 / 29	10	230.00
5000024	500	24 / 29	5	330.00

Flasks

5020 - ERLLENMEYER (CONICAL) FLASK

Narrow Mouth, With I/C Joint & Glass Stopper

- Equipped with interchangeable joints
- These flasks can be closed with a glass stopper
- The conical form makes them suitable for mixing of liquid
- While heating stopper should be removed



Product Code	Capacity ml	Interchangeable Joint	Quantity Per Case	Price / Piece ₹
5020009	25	14 / 23	10	210.00
5020012	50	19 / 26	10	250.00
5020016	100	24 / 29	20	275.00
5020021	250	24 / 29	20	320.00
5020024	500	24 / 29	10	455.00
5020029	1000	29 / 32	10	640.00
5020030	2000	29 / 32	10	910.00



5019 - ERLLENMEYER (CONICAL) FLASK

Narrow Mouth, With I/C Joint & Glass Stopper, Amber

- Complies with IS 1381 (Part I), DIN / ISO 1773
- Equipped with interchangeable joints
- These flasks can be closed with a glass stopper
- Uniform wall thickness distribution makes these flasks ideal for heating
- While heating stopper should be removed
- The conical form makes them suitable for mixing liquids
- Coloured in Amber to protect light-sensitive material
- The Amber colour is applied only to the external surface to prevent contamination with the testing material

Product Code	Capacity ml	Interchangeable Joint	Quantity Per Case	Price / Piece ₹
5019009	25	14 / 23	10	335.00
5019012	50	19 / 26	10	350.00
5019016	100	24 / 29	20	430.00
5019021	250	24 / 29	20	530.00
5019024	500	24 / 29	10	865.00



5021 - ERLLENMEYER (CONICAL) FLASK

With Screw Cap

- Supplied with PP screw cap autoclavable at 121°C
- The conical form makes them suitable for mixing of liquids

Product Code	Capacity ml	Neck Specification	Quantity Per Case	Price / Piece ₹
5021016	100	GL 25	20	265.00
5021018	150	GL 25	20	300.00
5021021	250	GL 45	20	350.00
5021024	500	GL 45	10	430.00
5021029	1000	GL 45	10	830.00
5021030	2000	GL 45	10	1185.00
5021033	5000	GL 45	2	5570.00

5025 - ERLNMEYER (CONICAL) FLASK

Baffled Bottom, With Screw Cap

- Supplied with screw cap made of polypropylene, autoclavable at 121°C
- Exhibits four baffled indents to provide consistent agitation and optimum aeration
- Optimum clarity for making critical observations
- Chemically inert and resistance to sodium leaching does not cause any pH changes in the liquid it is holdin
- Ideal culture vessel for microbial culture preparations, enzymatic dissociation of tissues, culturing of suspension cells for biopharma applications, plant cell culturing



Product Code	Capacity ml	Neck Specification	Quantity Per Case	Price / Piece ₹
5025021	250	GL 45	20	1950.00
5025024	500	GL 45	10	2380.00
5025029	1000	GL 45	10	3350.00
5025030	2000	GL 45	10	4110.00

4982 - ERLNMEYER (CONICAL) FLASK

Without Rim

- Complies with IS 1381(Part I), DIN / ISO 1773
- Uniform wall thickness distribution makes these flasks ideal for heating
- The conical form makes them suitable for mixing liquids
- Designed without a rim for use in the shaker machine
- The easy-to-read scale and large labelling field facilitate easy marking
- Graduated from 25 ml to 5000 ml



Product Code	Capacity ml	Approx O.D. x Height mm	Approx Neck O.D. mm	Quantity Per Case	Price / Piece ₹
4982027	750	114 x 210	42	10	430.00

Suitable for culture work, designed for use in shaker machine

4981 - ERLNMEYER (CONICAL) FLASK

Long Neck Without Rim

- Complies with IS 1381(Part I), DIN / ISO 1773
- Uniform wall thickness distribution makes these flasks ideal for heating
- Long neck designed for cotton plugs and metal caps
- The conical form makes them suitable for mixing liquids
- The easy-to-read scale and large labelling field facilitate easy marking
- Ideal for microbial culture work

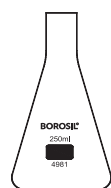

Product Code	Capacity ml	Approx O.D. x Height mm	Approx Neck O.D. mm	Quantity Per Case	Price / Piece ₹
4981021	250	78 x 154	27	10	190.00

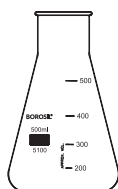

5100 - ERLLENMEYER (CONICAL) FLASK Wide Mouth

- Complies with IS 1381 /ISO 1773
- Uniform wall thickness distribution makes these flasks ideal for heating
- The conical form makes them suitable for mixing of liquids
- The easy-to-read scale and large labelling field facilitate easy marking
- Designed with a wide neck that makes cleaning and filling easier

Product Code	Capacity ml	Approx O.D. x Height mm	Approx Neck O.D. mm	Quantity Per Case	Price / Piece ₹
5100016	100	64 x 105	34	20	110.00
5100021	250	85 x 142	50	30	150.00
5100024	500	105 x 175	50	20	230.00
5100029	1000	130 x 220	56	10	405.00

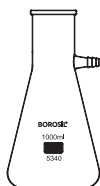

5340 - FILTER FLASK With Glass Tubulation

- These flasks are blown in special moulds
- The shape is designed to impart maximum mechanical strength
- The neck finish is designed for strength and to ensure good stopper fit
- Ideal for use with Bucher Funnel Category No. 36060 and Gooch Crucible
- No. 32060 with Sintered Discs that have different porosities

Product Code	Capacity ml	Approx O.D. x Height mm	Quantity Per Case	Price / Piece ₹
5340012	50	52 x 86	30	220.00
5340016	100	70 x 105	20	330.00
5340021	250	85 x 155	10	480.00
5340024	500	105 x 188	20	580.00
5340029	1000	135 x 230	10	880.00
5340030	2000	165 x 270	5	1785.00
5340033	5000	240 x 450	2	6360.00
5340038	10000*	236 x 420	1	11065.00
5340040	20000*	285 x 535	1	17665.00

* These flasks are bottle shaped

5400 - IODINE FLASK

With I/C Glass Stopper

- These flasks are made especially for the determination of Iodine value according to the methods of ASTM D-29
- Supplied Interchangeable Stopper
- Large labelling field for easy marking
- The handle of the stopper projects above the liquid seal, facilitating its removal



Product Code	Capacity ml	Interchangeable Joint Size	Quantity Per Case	Price / Piece ₹
5400016	100	24 / 29	10	230.00
5400021	250	24 / 29	10	290.00
5400024	500	24 / 29	10	360.00

5015 - TILT MEASURE

- Ideal for dispensing fixed volume of liquid
- Easy to use
 - Tilt the unit backward to fill
 - Tilt the unit forward to dispense
- Accuracy + 5% can be achieved



Product Code	Capacity ml	Flask Capacity ml	Quantity Per Case	Price / Piece ₹
5015005	5	100	5	805.00
5015006	10	250	5	840.00
5015008	20	250	10	940.00
5015009	25	250	10	1005.00
5015012	50	250	10	1190.00

Funnels

Funnels may be used for separating solids from liquids, liquids from liquids and occasionally, for pouring something into a container.

BOROSIL® brand Funnels are available in a comprehensive range for a variety of such applications. Sintered Glass Funnels are also available.

Separating Funnels come in globe, pear and cylindrical shapes with ground glass stopcocks and interchangeable stoppers. These Funnels are made of specially moulded blanks. Stopcock bores, body openings and stems are carefully aligned to facilitate the smooth and even flow of liquid with fast cut-off.

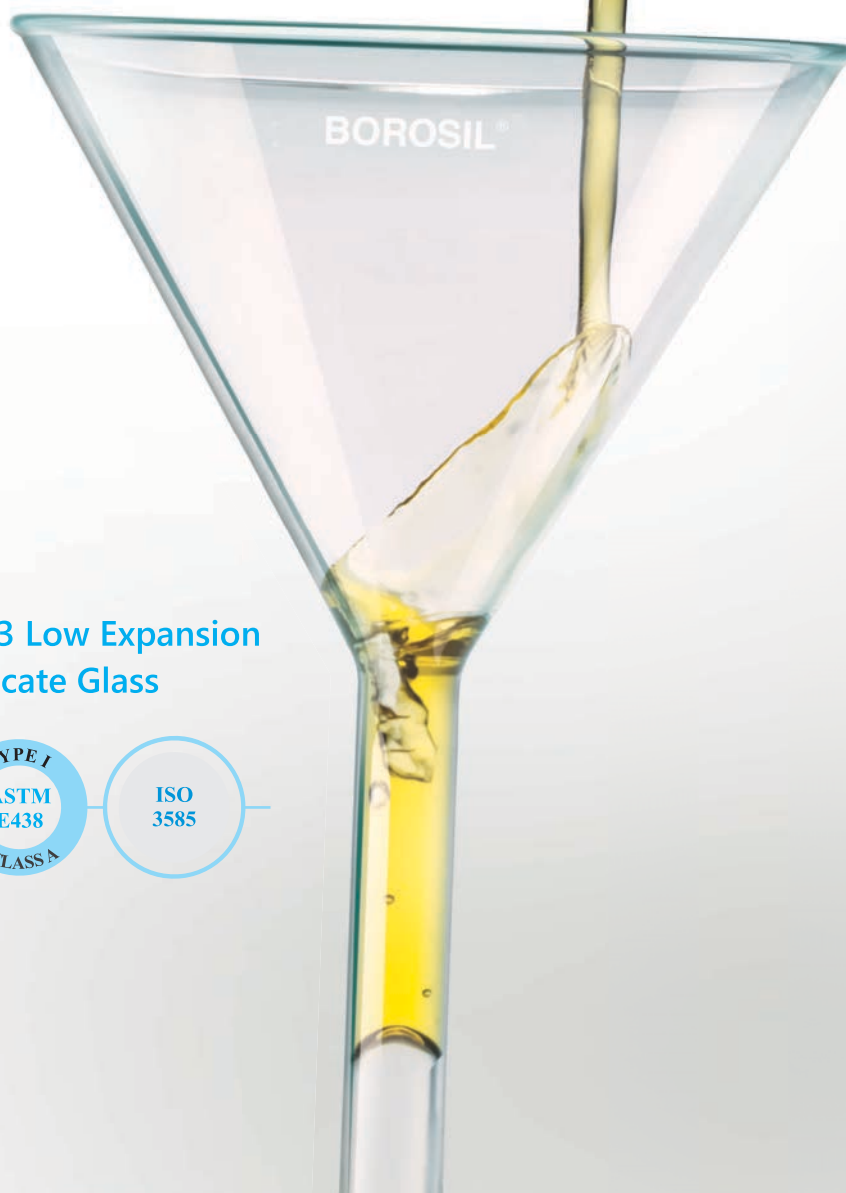

**Made from 3.3 Low Expansion
Borosilicate Glass**



6140 - GLASS FILTER FUNNEL

Short Stem

- Complies with IS 1591, DIN / ISO 4798
- Designed with a 60° bowl angle to ensure precise fitting of the filter paper
- High thermal shock resistance and chemical resistance
- Generally used for filtering and decanting liquids of varied densities

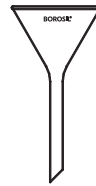

Product Code	Diameter mm	Stem Dimensions (mm)		Quantity Per Case	Price / Piece ₹
		OD	Length		
6140057	25*	6	25	30	90.00
6140058	35	6	35	30	115.00
6140065	50*	8	50	20	125.00
6140069	65*	8	65	20	140.00
6140071	75	8	75	20	140.00
6140077	100	10	100	40	190.00

- * Not covered in standard

6150 - FUNNEL TEST TUBES

- Specially designed for soil testing laboratory



Product Code	Capacity ml	Quantity Per Case	Price / Piece ₹
6150007	15	10	170.00
6150010	30	10	210.00

6220 - POWDER FUNNEL

With Stem

- Designed with a short wide stem to facilitate smooth flow
- Ideal for transferring powders

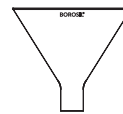

Product Code	Capacity ml	Quantity Per Case	Price / Piece ₹
6220080	125	30	400.00
6220081	150	20	425.00
6220087	200	4	1150.00
6220089	250	4	1655.00

6230 - POWDER FUNNEL

Stem With Cone

- Supplied with ground glass cone for easy fitting on flask
- Designed with a short wide stem to facilitate smooth flow
- Ideal for transferring powders

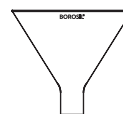

Product Code	Capacity ml	Quantity Per Case	Price / Piece ₹
6230080	125	20	600.00
6230081	150	20	690.00
6230087	200	4	1330.00
6230089	250	4	1910.00

- Joint size 24 / 29 for all capacities

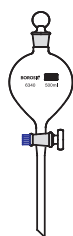

6340 - SEPARATING FUNNEL, GLOBE SHAPE With Glass Stopcock & I/C Glass Stopper

- Designed with globe shape and with a stem
- Generally used in the separation phase

Product Code	Capacity ml	Stopper Size	Quantity Per Case	Price / Piece ₹
6340017	125	19 / 26	10	1150.00
6340021	250	24 / 29	10	1260.00
6340024	500	24 / 29	10	1585.00
6340029	1000	29 / 32	5	2000.00
6340030	2000	29 / 32	10	3380.00
6340033	5000	34 / 35	1	7670.00



6400 - SEPARATING FUNNEL, PEAR SHAPE With Glass Stopcock & I/C Glass Stopper

- Complies with IS 1575, DIN / ISO 4800
- Designed with pear shape and with a stem
- Generally used in the separation phase

Product Code	Capacity ml	Stopper Size	Quantity Per Case	Price / Piece ₹
6400013	60*	14 / 23	10	980.00
6400017	125*	19 / 26	10	1065.00
6400021	250	24 / 29	10	1180.00
6400024	500	24 / 29	10	1555.00
6400029	1000	29 / 32	10	2030.00
6400030	2000	29 / 32	10	3695.00

* Not covered in standards.

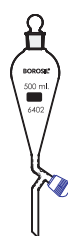

6402 - SEPARATING FUNNEL, PEAR SHAPE With Boroflo Stopcock And I/C Glass Stopper

- Complies with IS 1575, DIN / ISO 4800
- Designed with pear shape and with a stem
- Generally used in the separation phase

Product Code	Capacity ml	Stopper Size	Quantity Per Case	Price / Piece ₹
6402013	60*	14 / 23	10	875.00
6402017	125*	19 / 26	10	995.00
6402021	250	24 / 29	10	1100.00
6402024	500	24 / 29	10	1485.00
6402029	1000	29 / 32	10	1855.00
6402030	2000	29 / 32	10	3265.00

* Not covered in standards.

6403 - SEPARATING FUNNEL, PEAR SHAPE, With PTFE Stopcock And I/C Glass Stopper

- Complies with IS 1575, DIN / ISO 4800
- Designed with pear shape and with a stem
- Generally used in the separation phase

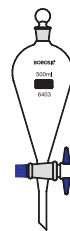

Product Code	Capacity ml	Stopper Size	Quantity Per Case	Price / Piece ₹
6403017	125*	19 / 26	10	1240.00
6403021	250	24 / 29	10	1355.00
6403024	500	24 / 29	10	1760.00
6403029	1000	29 / 32	10	2100.00
6403030	2000	29 / 32	10	3910.00

* Not covered in standards.



6405 - PRESSURE EQUILISING CYLINDRICAL FUNNEL With PTFE Stopcock

- Supplied with polypropylene stopper
- Equipped with totally grease free and self lubricating PTFE stopcock



Product Code	Capacity ml	Socket	Cone	Quantity Per Case	Price / Piece ₹
6405012	50	19 / 26	19 / 26	5	1185.00
6405016	100	19 / 26	19 / 26	5	1420.00
6405021	250	24 / 29	24 / 29	5	1625.00
6405024	500	24 / 29	24 / 29	5	2520.00



6408 - DROPPING FUNNEL, Graduated With Glass Stopcock

- Complies with IS 1575, DIN / ISO 4800
- Supplied with glass stopcock

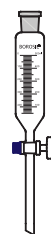

Product Code	Capacity ml	Stopper Size	Quantity Per Case	Price / Piece ₹
6408012	50	14 / 23	5	715.00
6408016	100	19 / 26	5	780.00
6408021	250	24 / 29	5	940.00
6408024	500	24 / 29	5	1260.00
6408029	1000	29 / 32	5	2090.00

* Not covered in standards.



Glass Parts & Accessories

Made from 3.3 Low Expansion
Borosilicate Glass



- CONES
- SOCKET
- ADAPTERS
- STOPPERS
- STIRRERS
- WATCH GLASSES
- WEIGHING SCOOP

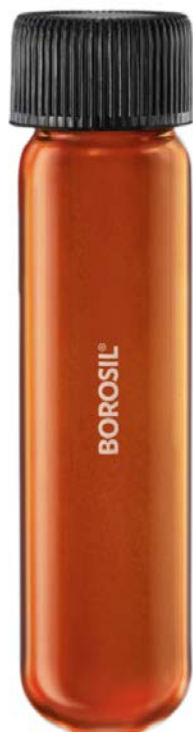

6560 - PLAIN SHANK SINGLE CONE

- Complies to DIN 12249
- Joints are made with precision grinding



Cones

Product Code	Cone Joint Size	Total Length (mm)	Quantity Per Case	Price / Piece ₹
6560010	10 / 19	120	5	140.00
6560012	12 / 21	120	5	150.00
6560014	14 / 23	120	5	165.00
6560019	19 / 26	125	5	200.00
6560024	24 / 29	135	5	240.00
6560029	29 / 32	135	5	300.00
6560034	34 / 35	150	5	425.00
6560040	40 / 38*	150	5	485.00
6560045	45 / 40*	150	5	580.00
6560050	50 / 42*	150	5	670.00
6560055	55 / 44	150	5	790.00

* Not covered in standard

6561- PLAIN SHANK DOUBLE CONE

- Complies to DIN 12249
- Joints are made with precision grinding



Product Code	Cone Joint Size	Total Length (mm)	Quantity Per Case	Price / Piece ₹
6561010	10 / 19	125	5	270.00
6561012	12 / 21	135	5	305.00
6561014	14 / 23	135	5	380.00
6561019	19 / 26	140	5	425.00
6561024	24 / 29	170	5	510.00
6561029	29 / 32	170	5	700.00
6561034	34 / 35	180	5	820.00
6561040	40 / 38	185	5	980.00



6580 - PLAIN SHANK SINGLE SOCKET

- Complies to DIN 12249
- Joints are made with precision grinding

Product Code	Cone Joint Size	Total Length (mm)	Quantity Per Case	Price / Piece ₹
6580010	10 / 19	120	5	150.00
6580012	12 / 21	120	5	175.00
6580014	14 / 23	120	5	195.00
6580019	19 / 26	125	5	200.00
6580024	24 / 29	135	5	245.00
6580029	29 / 32	135	5	300.00
6580034	34 / 35	150	5	425.00
6580040	40 / 38	150	5	520.00
6580045	45 / 40	150	5	670.00
6580050	50 / 42	150	5	760.00
6580055	55 / 44	150	5	945.00



6581 - PLAIN SHANK DOUBLE SOCKET

- Complies to DIN 12249
- Joints are made with precision grinding

Product Code	Cone Joint Size	Total Length (mm)	Quantity Per Case	Price / Piece ₹
6581010	10 / 19	125	5	245.00
6581012	12 / 21	135	5	295.00
6581014	14 / 23	135	5	340.00
6581019	19 / 26	140	5	380.00
6581024	24 / 29	170	5	425.00
6581029	29 / 32	170	5	510.00
6581034	34 / 35	180	5	700.00
6581040	40 / 38	185	5	760.00

8800 - ENLARGING CONNECTING ADAPTERS

- An outer interchangeable joint at the top and a smaller inner interchangeable joint at the base
- These joints are made to the same precision as all Borosil ground joints



Product Code	Socket Joint Size	Cone Joint Size	Quantity Per Case	Price / Piece ₹
8800A01	19 / 26	14 / 23	5	305.00
8800A02	24 / 29	14 / 23	5	380.00
8800A03	24 / 29	19 / 26	5	380.00
8800A04	29 / 32	19 / 26	5	450.00
8800A05	29 / 32	24 / 29	5	450.00
8800A06	34 / 35	19 / 26	5	580.00
8800A07	34 / 35	24 / 29	5	580.00
8800A08	34 / 35	29 / 32	5	580.00



Adapters

8820 - REDUCTION CONNECTING ADAPTERS

- An outer interchangeable joint at the top and a smaller inner interchangeable joint at the base
- These joints are made to the same precision as all Borosil ground joints.



Product Code	Socket Joint Size	Cone Joint Size	Quantity Per Case	Price / Piece ₹
8820A09	29 / 32	34 / 35	5	585.00
8820A10	14 / 23	19 / 26	5	305.00
8820A11	14 / 23	24 / 29	5	380.00
8820A13	19 / 26	29 / 32	5	450.00
8820A14	19 / 26	34 / 35	5	580.00
8820A15	24 / 29	29 / 32	5	450.00
8820A16	24 / 29	34 / 35	5	580.00
8820A17	29 / 32	40 / 38	5	655.00
8820A18	19 / 26	24 / 29	5	380.00



8830 - RECEIVER BENT ADAPTER WITH VACUUM CONNECTION

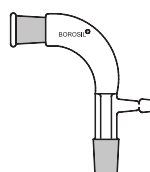

Product Code	Socket Joint Size	Cone Joint Size	Quantity Per Case	Price / Piece ₹
8830614	14 / 23	14 / 23	5	465.00
8830619	19 / 26	19 / 26	5	510.00
8830719	19 / 26	24 / 29	5	540.00
8830624	24 / 29	24 / 29	5	585.00
8830724	24 / 29	29 / 32	5	740.00
8830629	29 / 32	29 / 32	5	815.00



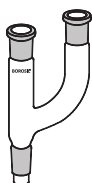

8831 - MULTIPLE ADAPTER With Two Parallel Necks

Product Code	Socket Joint Size	Cone Joint Size	Quantity Per Case	Price / Piece ₹
8831614	14 / 23	14 / 23	5	315.00
8831619	19 / 26	19 / 26	5	350.00
8831719	19 / 26	24 / 29	5	390.00
8831624	24 / 29	24 / 29	5	420.00
8831819	19 / 26	34 / 35	5	490.00
8831629	29 / 32	29 / 32	5	550.00

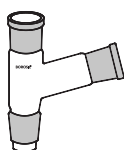

8832 - MULTIPLE ADAPTER With Two Necks

- With two neck - one Vertical & one at 45°

Product Code	Socket Joint Size	Cone Joint Size	Quantity Per Case	Price / Piece ₹
8832619	19 / 26	19 / 26	5	350.00
8832719	19 / 26	24 / 29	5	370.00
8832819	19 / 26	34 / 35	5	450.00

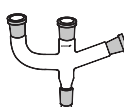

8833 - MULTIPLE ADAPTER With Three Necks

- With three necks - two parallel necks & one at 45°

Product Code	Socket Joint Size	Cone Joint Size	Quantity Per Case	Price / Piece ₹
8833A19	19 / 26	24 / 29	5	510.00
8833B19	19 / 26	29 / 32	5	585.00
8833C19	19 / 26	34 / 35	5	670.00
8833D19	19 / 26	45 / 40	5	860.00

8834 - SWAN NECK ADAPTER

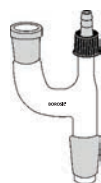

Product Code	Socket Joint Size	Cone Joint Size	Quantity Per Case	Price / Piece ₹
8834619	19 / 26	19 / 26	5	340.00
8834719	19 / 26	24 / 29	5	270.00
8834624	24 / 29	24 / 29	5	410.00
8834724	24 / 29	34 / 35	5	480.00



Adapters

8835 - ADAPTER CONE / RUBBER TUBING

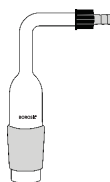

Product Code	Socket Joint Size	Quantity Per Case	Price / Piece ₹
8835A10	10 / 19	5	185.00
8835A14	14 / 23	5	200.00
8835A19	19 / 26	5	235.00
8835A24	24 / 29	5	270.00
8835A29	29 / 32	5	370.00



8836 - ADAPTER CONE - FLEXIBLE TUBING



Product Code	Socket Joint Size	Quantity Per Case	Price / Piece ₹
8836A14	14 / 23	5	200.00
8836A19	19 / 26	5	230.00
8836A24	24 / 29	5	270.00
8836A29	29 / 32	5	330.00
8836B10	10 / 19	5	220.00
8836B14	14 / 23	5	300.00
8836B19	19 / 26	5	300.00
8836B24	24 / 29	5	350.00
8836B29	29 / 32	5	420.00





8837 - ADAPTER RECEIVER

Straight Socket To Rubber

Product Code	Socket Joint Size	Quantity Per Case	Price / Piece ₹
8837A14	14 / 23	5	200.00
8837A19	19 / 26	5	230.00
8837A24	24 / 29	5	260.00
8837A34	34 / 35	5	340.00

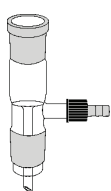

8838 - ADAPTER RECEIVER

Straight With Vacuum

Product Code	Socket Joint Size	Cone Joint Size	Quantity Per Case	Price / Piece ₹
8838614	14 / 23	14 / 23	5	270.00
8838714	14 / 23	19 / 26	5	285.00
8838814	14 / 23	24 / 29	5	350.00
8838619	19 / 26	19 / 26	5	340.00
8838719	19 / 26	24 / 29	5	370.00
8838624	24 / 29	24 / 29	5	405.00
8838724	24 / 29	29 / 32	5	490.00

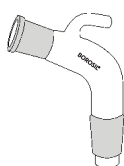

8839 - ADAPTER RECEIVER

Bent With Vent

Product Code	Socket Joint Size	Cone Joint Size	Quantity Per Case	Price / Piece ₹
8839614	14 / 23	14 / 23	5	270.00
8839619	19 / 26	19 / 26	5	310.00
8839719	19 / 26	24 / 29	5	370.00
8839624	24 / 29	24 / 29	5	405.00
8839629	29 / 32	29 / 32	5	585.00

8840 - ADAPTER CONES SCREW THREAD

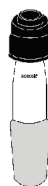

Product Code	Socket Joint Size	Quantity Per Case	Price / Piece ₹
8840A14	14 / 23	5	285.00
8840A19	19 / 26	5	285.00
8840A24	24 / 29	5	330.00
8840A29	29 / 32	5	430.00



8841 - SLOPPING PLANE STILL HEAD

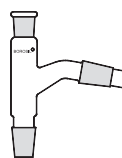

Product Code	Flask Cone	Cond. Cone	Socket	Quantity Per Case	Price / Piece ₹
8841610	10 / 19	10 / 19	10 / 19	5	420.00
8841614	14 / 23	14 / 23	14 / 23	5	440.00
8841619	19 / 26	19 / 26	14 / 23	5	500.00
8841819	19 / 26	19 / 26	19 / 26	5	530.00
8841724	24 / 29	19 / 26	14 / 23	5	560.00
8841624	24 / 29	24 / 29	19 / 26	5	605.00
8841729	29 / 32	19 / 26	14 / 23	5	620.00
8841629	29 / 32	29 / 32	14 / 23	5	890.00
8841634	34 / 35	19 / 26	14 / 23	5	715.00
8841734	34 / 35	24 / 29	14 / 23	5	835.00
8841834	34 / 35	34 / 35	14 / 23	5	2385.00



8844 - ADAPTER RECEIVER

Multiple Connectivity

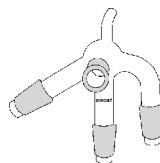

Product Code	Socket Joint Size	Cone Joint Size	Quantity Per Case	Price / Piece ₹
8844614	14 / 23	14 / 23	5	815.00
8844714	14 / 23	19 / 26	5	860.00
8844619	19 / 26	19 / 26	5	960.00



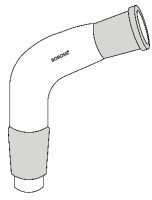

8845 - ADAPTER RECEIVER

Plain Bent

Product Code	Socket Joint Size	Cone Joint Size	Quantity Per Case	Price / Piece ₹
8845619	19 / 26	19 / 26	5	310.00
8845719	19 / 26	24 / 29	5	340.00
8845624	24 / 29	24 / 29	5	405.00
8845629	29 / 32	29 / 32	5	585.00



8846 - ADAPTER RECOVERY BENT

With Sloping End

Product Code	Socket Joint Size	Cone Joint Size	Quantity Per Case	Price / Piece ₹
8846614	14 / 23	14 / 23	5	230.00
8846724	24 / 29	14 / 23	5	310.00
8846619	19 / 26	19 / 26	5	310.00
8846824	24 / 29	19 / 26	5	320.00
8846729	29 / 32	19 / 26	5	420.00
8846734	34 / 35	19 / 26	5	450.00
8846624	24 / 29	24 / 29	5	320.00
8846834	34 / 35	24 / 29	5	500.00
8846634	34 / 35	34 / 35	5	560.00

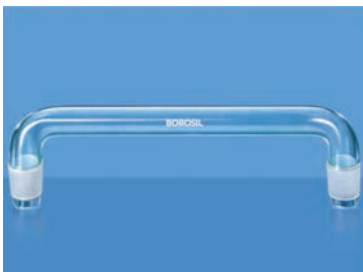

8847 - ADAPTER RECOVERY

Bent Vertical

Product Code	Socket Joint Size	Cone Joint Size	Quantity Per Case	Price / Piece ₹
8847614	14 / 23	14 / 23	5	330.00
8847619	19 / 26	19 / 26	5	405.00
8847724	24 / 29	14 / 23	5	430.00
8847624	24 / 29	24 / 29	5	510.00
8847629	29 / 32	29 / 32	5	670.00

8849 - CLAISEN HEAD SLOPING

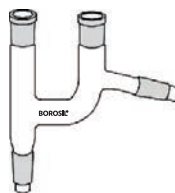

Product Code	Socket Joint Size	Cone Joint Size	Quantity Per Case	Price / Piece ₹
8849614	14 / 23	14 / 23	5	550.00
8849619	19 / 26	19 / 26	5	605.00
8849724	24 / 29	19 / 26	5	640.00
8849624	24 / 29	24 / 29	5	690.00
8849629	29 / 32	29 / 32	5	750.00
8849734	34 / 35	24 / 29	5	800.00

8850 - ADAPTER RECEIVER

Plain Vertical



Product Code	Socket Joint Size	Cone Joint Size	Quantity Per Case	Price / Piece ₹
8850614	14 / 23	14 / 23	5	500.00
8850719	19 / 26	24 / 29	5	550.00
8830724	24 / 29	29 / 32	5	620.00

8851 - SPLASH HEAD

Vertical, Pear Shape

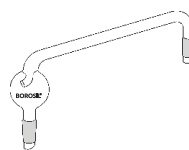

Product Code	Socket Joint Size	Cone Joint Size	Quantity Per Case	Price / Piece ₹
8851619	19 / 26	19 / 26	5	620.00
8851724	24 / 29	19 / 26	5	640.00
8851624	24 / 29	24 / 29	5	800.00
8851629	29 / 32	29 / 32	5	860.00

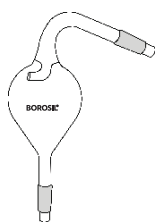

8852 - SPLASH HEAD SLOPING Pear Shape

Product Code	Socket Joint Size	Cone Joint Size	Quantity Per Case	Price / Piece ₹
8852619	19 / 26	19 / 26	5	585.00
8852724	24 / 29	19 / 26	5	620.00
8852624	24 / 29	24 / 29	5	670.00
8852629	29 / 32	29 / 32	5	690.00

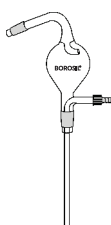

8853 - STEAM DISTILLATION HEADS

Product Code	Socket Joint Size	Cone Joint Size	Quantity Per Case	Price / Piece ₹
8853724	24 / 29	19 / 26	5	860.00
8853734	34 / 35	19 / 26	5	1060.00
8853834	34 / 35	24 / 29	5	1090.00

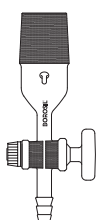

8854 - ADAPTOR Straight cone with stopcock

Product Code	Cone Joint Size	Stopcock Bore mm	Quantity Per Case	Price / Piece ₹
8854014	14 / 23	2	5	1290.00
8854019	19 / 26	2	5	1305.00
8854024	24 / 29	2	5	1390.00
8854029	29 / 32	2	5	1555.00
8854034	34 / 35	2	5	1810.00

8855 - ADAPTOR

Straight Socket With Stopcock

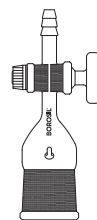

Product Code	Cone Joint Size	Stopcock Bore mm	Quantity Per Case	Price / Piece ₹
8855014	14 / 23	2	5	1485.00
8855019	19 / 26	2	5	1495.00
8855024	24 / 29	2	5	1605.00
8855029	29 / 32	2	5	1715.00
8855034	34 / 35	2	5	2050.00

8856 - ADAPTOR

Bent Cone With Stopcock

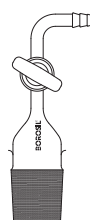

Product Code	Cone Joint Size	Stopcock Bore mm	Quantity Per Case	Price / Piece ₹
8856014	14 / 23	2	5	1485.00
8856019	19 / 26	2	5	1495.00
8856024	24 / 29	2	5	1605.00
8856029	29 / 32	2	5	1715.00
8856034	34 / 35	2	5	1940.00

8857 - ADAPTOR

Bent Socket With Stopcock

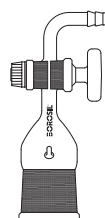

Product Code	Cone Joint Size	Stopcock Bore mm	Quantity Per Case	Price / Piece ₹
8857014	14 / 23	2	5	1580.00
8857019	19 / 26	2	5	1595.00
8857024	24 / 29	2	5	1700.00
8857029	29 / 32	2	5	1945.00
8857034	34 / 35	2	5	2130.00



8861 - THERMOMETER POCKET Long Type

Product Code	Cone Joint Size	Stopcock Bore mm	Quantity Per Case	Price / Piece ₹
8861014	14 / 23	2	10	380.00
8861019	19 / 26	2	10	480.00
8861024	24 / 29	2	10	535.00
8861029	29 / 32	2	10	860.00
8861034	34 / 35	2	10	1015.00



8862 - THERMOMETER POCKET Short Type

Product Code	Cone Joint Size	Stopcock Bore mm	Quantity Per Case	Price / Piece ₹
8862014	14 / 23	2	10	420.00
8862019	19 / 26	2	10	510.00
8862024	24 / 29	2	10	580.00

8100 - Glass Stoppers

Penny head, Clear

Product Code	Stopper Number	Interchangeable Joint Size	Quantity Per Case	Price / Piece ₹
ISO / DIN Standard (Long Neck)				
8100A10	–	10 / 19	20	90.00
8100A12	–	12 / 21	20	95.00
8100A14	–	14 / 23	20	95.00
8100A19	–	19 / 26	20	110.00
8100A24	–	24 / 29	20	210.00
8100A29	–	29 / 32	20	255.00
8100A34	–	34 / 35	20	270.00
ASTM Standard (Short Neck)				
8110008	# 8	8.25 / 10	20	90.00
8110009	# 9	9.4 / 14	20	100.00
8110013	# 13	13.4 / 14	20	110.00
8110016	# 16	16.5 / 15	20	210.00
8110019	# 19	19.7 / 17	20	255.00
8110022	# 22	22.05 / 20.5	20	270.00
8110027	# 27	27.15 / 21.5	20	280.00
IS Standard as per Old design (Till the stocks last)				
8100010	–	10 / 15	20	90.00
8100014	–	14 / 15	20	95.00
8100019	–	19 / 20	20	110.00
8100024	–	24 / 25	20	210.00



Stoppers

8400 - Glass Stoppers

Penny head, Amber

- With Interchangeable Ground Joint

Product Code	Stopper Number	Interchangeable Joint Size	Quantity Per Case	Price / Piece ₹
ISO / DIN Standard (Long Neck)				
8400A10	–	10 / 19	20	110.00
8400A12	–	12 / 21	20	140.00
8400A14	–	14 / 23	20	140.00
8400A19	–	19 / 26	20	160.00
8400A24	–	24 / 29	20	250.00
8400A29	–	29 / 32	20	295.00
8400A34	–	34 / 35	20	320.00
ASTM Standard				
8410008	# 8	8.25 / 10	20	110.00
8410009	# 9	9.4 / 14	20	120.00
8410013	# 13	13.4 / 14	20	135.00
8410016	# 16	16.5 / 15	20	250.00
8410019	# 19	19.7 / 17	20	305.00
8410022	# 22	22.05 / 20.5	20	325.00
8410027	# 27	27.15 / 21.5	20	335.00
IS Standard as per Old design (Till the stocks last)				
8400010	–	10 / 15	20	110.00
8400014	–	14 / 15	20	140.00
8400019	–	19 / 20	20	160.00
8400024	–	24 / 25	20	250.00



Plastic Stopper - ISO, except ASTM
Stock on order

Stirrer

Stirrers are used in laboratories for mixing of liquids and decanting the supernatants. Stir rods with blade helps in creating some turbulence and allows efficient mixing of solutions. BOROSIL stirrers are made of 3.3 borosilicate glass and equipped with a chemically inert PTFE blade to maintain the purity of substances while mixing.

Stirrers

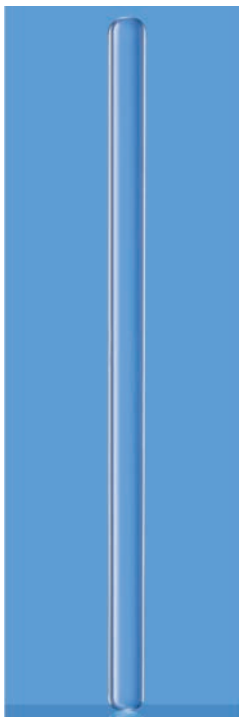

9850 - GLASS STIRRER ROD

Product Code	Approx O.D. x Length mm	Quantity Per Case	Price / Piece ₹
9850107	7 x 150	100	30.00
9850207	7 x 205	100	40.00
9850307	7 x 255	100	40.00
9850407	7 x 305	100	50.00
9850109	9 x 150	100	40.00
9850209	9 x 205	100	50.00
9850309	9 x 255	100	60.00
9850409	9 x 305	100	60.00

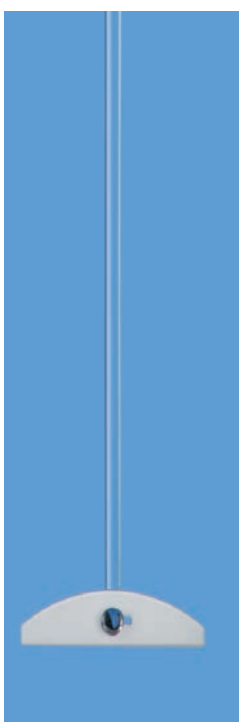

9860 - GLASS STIRRER ROD With PTFE Blade

- Provided with chemically inert PTFE blade
- Ideal for very sensitive samples
- Application in synthetic laboratory

Product Code	Shaft Dia x Length mm	Blade width mm	Socket	Suitable for flask capacity	Quantity Per Case	Price / Piece ₹
9860065	6 x 450	50	19 / 26	500 ml	10	350.00
9860071	6 x 450	75	24 / 29	1000 ml	10	430.00
9860077	8 x 600	100	34 / 35	2000 ml	5	550.00
9860080	8 x 600	125	34 / 35	5000 ml	5	605.00
9860081	10 x 750	150	55 / 44	10000 ml	5	1075.00
9860087	10 x 750	200	55 / 44	20000 ml	5	1200.00

Watch Glass

Watch glasses are used most often in chemical laboratories for different applications such as evaporating liquids, weighing of substances, covers for beakers to prevent contamination. BOROSIL watch glass is designed with an optimum concave to suit these applications.

9986 - WATCH GLASSES

S - Line

- Made of sodalime glass
- A special process is used that results in an absolutely flat curved surface
- High clarity, free of bubbles
- All of them are moulded to the same radius of curvature for convenient stacking

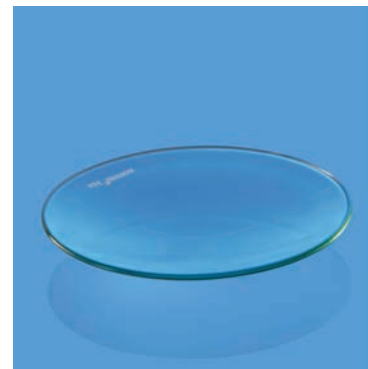
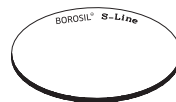

Watch Glass
Weighing Scoop

Product Code	Size mm	Quantity Per Case	Price / Piece ₹
9986072	80	50	90.00
9986077	100	50	100.00
9986079	120	20	110.00
9986081	150	20	140.00

Weighing Scoop

Borosil Weighing Scoops are primarily used when small quantities of powder, liquid or semi-solid material need to be weighed. The powder can be introduced into the receiving vessel through the tubular stem.

7200 - GLASS WEIGHING SCOOP

- Weighing scoops have an open tubular arm.
- Ideal for weighing small quantities of dyes and powders



Product Code	Capacity ml	Quantity Per Case	Price / Piece ₹
7200P45	0.5	10	240.00
7200001	1	10	215.00
7200002	2	10	215.00
7200003	3	10	205.00
7200076	6	10	225.00
7200006	10	10	260.00

BOROSIL®

Mortar And Pestle

Made of borosilicate glass
for fine grinding of high purity substances



Proudly Made in India Since 1962

Mortar and
Pestle

7210 - GLASS MORTAR AND PESTLE **NEW**

Inside Rough

- Inside surface is made rough to ensure fine grinding
- Designed with pour out for which allows easy decanting of liquids

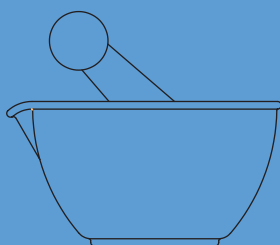

Product Code	Top Diameter mm	Height* mm	Quantity Per Case	Price / Piece ₹
7210040	80	60	2	5100.00
7210041	100	75	2	6200.00
7210042	150	110	2	10100.00

* Height indicated is of mortar only

BOROSIL®

Museum Jars

Made of borosilicate glass
for clear observation of specimens



Proudly Made in India Since 1962

Museum Jar

6910 - RECTANGULAR MUSEUM JAR

With Lid

- Jar made of 3.3 low expansion borosilicate glass and lid made from sodalime glass
- Specially blown to give sturdiness and long life
- Top edges are flat ground
- Not recommended for use over a direct flame or on a hot plate
- For storage and display of preserved organs and organisms in Museums, Hospitals and Medical Colleges

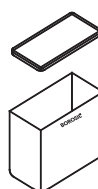

Product Code	Approx Height x Length x Breadth mm	Quantity Per Case	Price / Piece ₹
6910M41	200 x 125 x 125	1	8100.00
6910M42	200 x 150 x 100	1	8580.00
6910M43	220 x 195 x 80	1	9545.00
6910M44	250 x 165 x 140	1	9990.00
6910M45	250 x 250 x 120	1	12020.00
6910M46	360 x 150 x 100	1	20150.00

BOROSIL®

an ISO 9001: 2015 certified company | PRICES EXCLUSIVE OF TAXES | For products listed on this page use HSN code 70179090



9800 - TEST TUBES

With Rim

- Complies with IS 2618, DIN / ISO 4142
- Designed with a round bottom and a rim
- Made thick-walled, mechanically very resistant
- High thermal shock resistance

Product Code	Capacity ml	Approx O.D. x Length mm	Quantity Per Case	Price / Piece ₹
9800U01	3	10 x 75	800	8.85
9800U02	5	12 x 75	800	8.85
9800U03	7	12 x 100	800	12.55
9800U15	4	13 x 55*	800	13.55
9800U04	13	15 x 125	800	14.90
9800U05	15	15 x 150	400	17.35
9800U06	27	18 x 150	400	18.60
9800U07	38	25 x 100#	200	23.50
9800U08	55	25 x 150	200	28.45
9800U09	70	25 x 200	100	37.20
9800U10	100	32 x 200	50	55.65
9800U11	170	38 x 200	50	67.85

* IS : 3740 for tube widal

Not covered in the standard



9820 - TEST TUBES

Without Rim

- Complies with IS 2618, DIN / ISO 4142
- Designed with a round bottom and without rim
- Made thick-walled, mechanically very resistant
- High thermal shock resistance

Product Code	Capacity ml	Approx O.D. x Length mm	Quantity Per Case	Price / Piece ₹
9820U16	1	7 x 60*	800	8.75
9820U01	3	10 x 75***	800	8.85
9820U02	5	12 x 75**/***	800	8.85
9820U03	7	12 x 100***	800	12.55
9820U17	8	12 x 125***	800	12.65
9820U04	13	15 x 125	800	14.90
9820U05	15	15 x 150	400	17.35
9820U12	12	16 x 100***	800	16.15
9820U18	20	16 x 150***	400	21.00
9820U06	27	18 x 150	400	18.60
9820U19	25	19 x 125***	400	21.00
9820U07	38	25 x 100#	200	23.50
9820U08	55	25 x 150***	200	28.45
9820U09	70	25 x 200	100	37.20
9820U10	100	32 x 200	50	55.65
9820U11	170	38 x 200	50	67.85

* IS:3740 - 1966 for DURHAM FERMENTATION

** IS:3740 - 1966 for KAHN & WASSERMAN TEST

*** IS:3740 - 1966 for BACTERIOLOGICAL TEST

Not covered in the standard

9830 - GRADUATED TEST TUBE

With I/C Glass Stopper

- Supplied with interchangeable glass stopper
- Graduations in amber enamel
- Made thick-walled, mechanically very resistant
- High thermal shock resistance
- These test tubes are graduated for greater precision

Product Code	Capacity ml	Approx O.D. x Length mm	Stopper Size	Quantity Per Case	Price / Piece ₹
9830006	10	17 x 160	10 / 19	10	215.00
9830007	15	19 x 150	14 / 23	10	240.00
9830008	20	19 x 160	14 / 23	10	250.00
9830010	30	25 x 155	19 / 26	10	260.00
9830012	50	25 x 200	19 / 26	10	275.00
9830016	100	34 x 210	24 / 29	10	415.00



9831 - GRADUATED TEST TUBE **NEW**

With I/C Glass Stopper, Amber

- Supplied with interchangeable glass stopper
- Graduations in white enamel
- Amber coating on exterior surfaces to facilitate use with light sensitive solutions
- Made thick-walled, mechanically very resistant
- High thermal shock resistance
- These test tubes are graduated for greater precision

Product Code	Capacity ml	Approx O.D. x Length mm	Stopper Size	Quantity Per Case	Price / Piece ₹
9831006	10	17 x 160	10 / 19	10	290.00
9831007	15	19 x 150	14 / 23	10	325.00
9831008	20	19 x 160	14 / 23	10	335.00
9831010	30	25 x 155	19 / 26	10	350.00
9831012	50	25 x 200	19 / 26	10	370.00
9831016	100	34 x 210	24 / 29	10	560.00

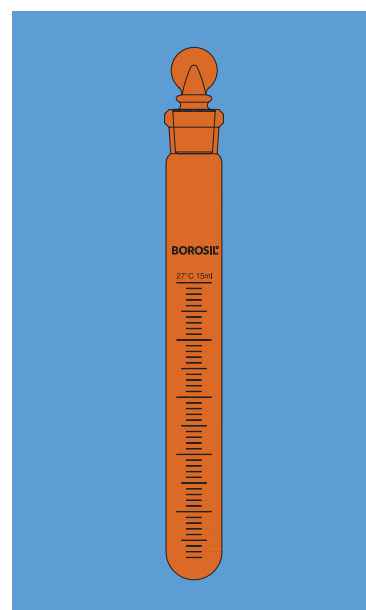

9829 - TEST TUBE **NEW**

Plain, With I/C Glass Stopper

- Supplied with interchangeable glass stopper
- Made thick-walled, mechanically very resistant
- High thermal shock resistance

Product Code	Capacity ml	Approx O.D. x Length mm	Stopper Size	Quantity Per Case	Price / Piece ₹
9829006	10	17 x 160	10 / 19	10	195.00
9829007	15	19 x 150	14 / 23	10	215.00
9829008	20	19 x 160	14 / 23	10	225.00
9829010	30	25 x 155	19 / 26	10	235.00
9829012	50	25 x 200	19 / 26	10	250.00
98291016	100	34 x 210	24 / 29	10	375.00

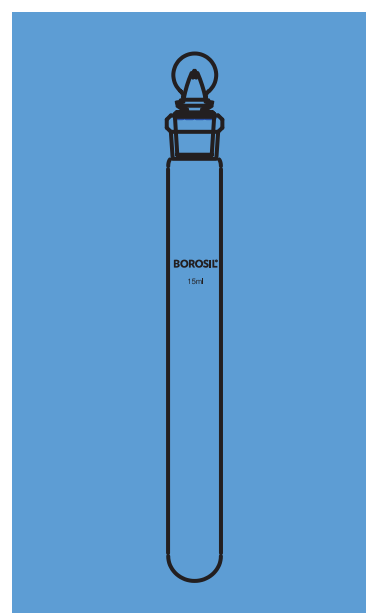



9821 - FLAT BOTTOM TUBE

Without Rim

- Designed with flat bottom and without rim
- High thermal shock resistance
- Used for pathological tests and disintegration apparatus

Product Code	Approx O.D. x Length mm	Quantity Per Case	Price / Piece ₹
9821U42	12 x 75	800	22.00



9822 - FLAT BOTTOM TUBE

With Rim

- Designed with flat bottom and with rim
- High thermal shock resistance
- Used for pathological tests and disintegration apparatus

Product Code	Approx O.D. x Length mm	Quantity Per Case	Price / Piece ₹
9822U06	18 x 138	400	40.00
9822U07	18 x 55	100	30.00
9822U04	14 x 110	800	40.00

8060 - CENTRIFUGE TUBE

Plain

- Made of uniformly drawn high quality tubing for extended service life
- Designed with conical bottom for the higher density fraction collection at the bottom of the tube
- Consequently, even small amounts of solids can be collected and separated



Product Code	Capacity ml	Approx O.D. x Length mm	Quantity Per Case	Price / Piece ₹
8060007	15	17 x 120	100	70.00



Tubes

8080 - CENTRIFUGE TUBE

Graduated

- Made of uniformly drawn high quality tubing for extended service life
- Designed with conical bottom for the higher density fraction collection at the bottom of the tube
- Consequently, even small amounts of solids can be collected and separated
- Graduated for greater precision



Product Code	Capacity ml	Approx O.D. x Length	Quantity Per Case	Price / Piece ₹
8080007	15	17 x 120	30	140.00
8080012	50	29 x 140	20	280.00

Amber colour Centrifuge tube available Product Code: 8081



8084 - CENTRIFUGE TUBE

Graduated With I/C Glass Stopper

- Made of uniformly drawn high quality tubing for extended service life
- Designed with conical bottom for the higher density fraction collection at the bottom of the tube
- Consequently, even small amounts of solids can be collected and separated
- Graduated for greater precision
- Supplied with glass stopper



Product Code	Capacity ml	Approx O.D. x Length mm	Quantity Per Case	Price / Piece ₹
8084007	15	17 x 145	30	420.00
8084012	50	26 x 165	10	530.00



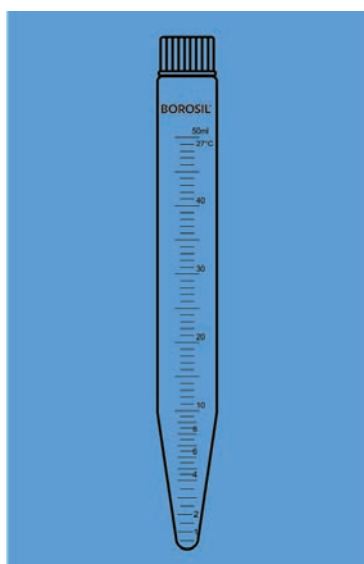

8090 - CENTRIFUGE TUBE

Graduated With PP Screw Cap

- Supplied with screw cap made of polypropylene
- Made of uniformly drawn high quality tubing for extended service life
- Designed with conical bottom for the higher density fraction collection at the bottom of the tube
- Consequently, even small amounts of solids can be collected and separated
- Graduated for greater precision

Product Code	Capacity ml	Approx O.D. x Length	Quantity Per Case	Price / Piece ₹
8090007	15	17 x 130	30	560.00
8090012	50	29 x 150	10	740.00

Amber colour Centrifuge tube available Product Code: 8091



8320 - CENTRIFUGE TUBE HEAVY DUTY

With Spout, Plain, Short Conical Bottom

- Made of uniformly drawn high quality tubing with increased wall thickness
- Spout allows easy decanting of liquids
- Designed with conical bottom for the higher density fraction collection at the bottom of the tube

Product Code	Capacity ml	Approx O.D. x Length mm	Quantity Per Case	Price / Piece ₹
8320011	40	29 x 116	20	190.00

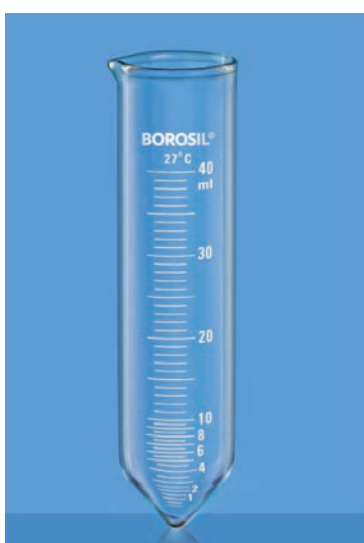

8340 - CENTRIFUGE TUBE HEAVY DUTY

With Spout, Graduated, Short Conical Bottom

- Made of uniformly drawn high quality tubing with increased wall thickness
- Spout allows easy decanting of liquids
- Designed with conical bottom for the higher density fraction collection at the bottom of the tube
- Graduated tubes for greater precision

Product Code	Capacity ml	Approx O.D. x Length mm	Quantity Per Case	Price / Piece ₹
8340011	40	29 x 116	20	345.00

Graduated upto 10 ml in 0.5 ml and from 10 ml to 40 ml in 1 ml divisions

7840 - FOLIN - WU BLOOD SUGAR TUBE

- Complies with IS 3740
- Made of uniformly drawn high quality tubing for extended service life
- The tube is calibrated at 12.5 ml and 25 ml



Product Code	Capacity ml	Approx O.D. x Length mm	Quantity Per Case	Price / Piece ₹
7840009	25	20 x 220	20	260.00



9835 - COD DIGESTION TUBE

- Made from thick-walled and mechanically resistant borosilicate glass
- Used in COD disintegration



Product Code	Approx O.D. x Length mm	Quantity Per Case	Price / Piece ₹
9835A01	36 x 205	10	440.00
9835001	39 x 205	10	440.00



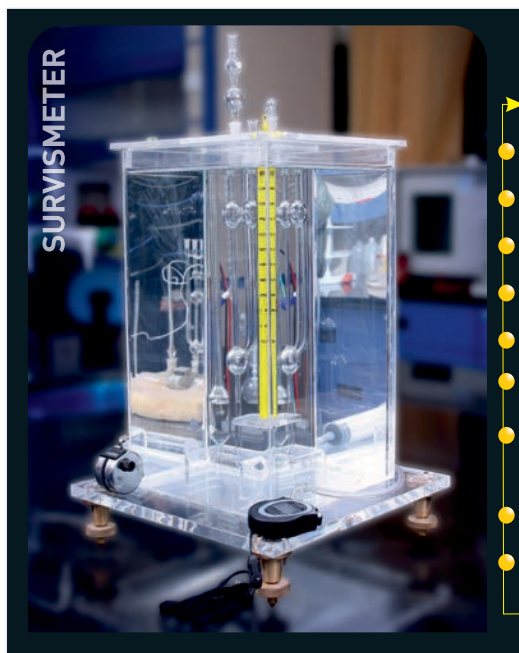

Features

- Multi data device
- Vibration free transparent casing
- Easy handling
- Easy sampling
- Easy data process
- No air contamination because the sample is jacketed within respective bulbs
- Boon for physicochemical characterization of volatile, inflammables, carcinogenic liquids
- Eco-friendly
- Homogeneous Temperature control

Cat. No.	Description	Quantity Per Case	Price ₹
3453	Borosil Mansingh Survismeter For Measurement of surface Tension and Viscosity	1 Set	97500.00

For centuries, surface tension (γ) and viscosity (η) data have been measured using separate instruments, resulting in wastage of time and materials. Made of Borosil Glass material, Borosil Mansingh Survismeter has been designed to measure surface tension, interfacial tension, wetting coefficient, viscosity and friccohesity data to rationalise frictional and cohesive forces, respectively. Friccohesity focuses on a complete friccochemistry of giants and supramolecular mixtures. Borosil Mansingh Survismeter is a state-of-the-art apparatus for measurement of surface tension (± 0.01 mN/m), interfacial tension

(± 0.01 mN/m), viscosity ($\pm 10^{-4}$ mPa.S), wetting coefficient (± 0.01 mPa.cm²) friccohesity ($\pm 10^{-6}$ s/cm) and related physicochemical parameters generated from intramolecular electrostatical shifts.

Borosil Mansingh Survismeter, being a green science TSAD (Trusted Sustainable Analytical Device), measures the above mentioned PCI (PhysicoChemical Indicators), while simultaneously saving 98% of experimental resources, infrastructure and skilled manpower, for interacting and reacting molecular materials.

A breakthrough in laboratory instruments, Borosil Mansingh Survismeter has wider analytical potential for quality control and formulations in material applied sciences. It has unique essential facilities and cutting edge features based on 'On & Off' or '0 & 1' circuitry functional loops.

Fundamentally, Borosil Mansingh Survismeter measures surface tension, interfacial tension, wetting coefficient, viscosity and friccohesity simultaneously of aqueous, non-aqueous, aprotic dipolar, polar, protic polar and non-polar solvents and mixtures within wider ranges.

- The absolute and relative parameters are measured with 95.5% CV (Confidence Variance).
- It works on the theory of R4M4 [Reduce Reuse Recycle Redesign - Multipurpose Multidimensional Multifaceted Multitracking of materials and methods with highly précised and accurate experimental results, along with 100% inhibition of polluting discharges in experimental determinations.

- The parameters measured with Borosil Mansingh Survisometer are highly significant and reliable for quality analysis of pharmaceuticals, biochemicals, cosmetics, agrochemicals, food and beverages, petroleum and oils, polymer and proteins, sol gels, soaps and detergents, inks, colloids, emulsion technology, pesticides, agrochemicals, insecticides, cutting oils, lubricating, viscous, moderately viscous and highly viscous materials.
- It is especially useful for characterising liquid mixtures of biopolymers, supramolecular chemistry, biotechnological processes and molecular interaction engineering of biomolecular devices, tracking interaction molecular forces, water binding capacities and structural changes during processes.
- It explains the features of Intramolecular Multiple Force Theory (IMMFT) applicable to giant supramolecules, dendrimers and biocomplexes used in several adverse temperature and pressure conditions.
- Borosil Mansingh Survisometer is an asset in case of volatile, moderately and highly volatile liquids and mixtures, volatile organic compounds, flammable liquids and carcinogenic materials as the samples are completely jacketed especially for surface tension, interfacial tension and wetting coefficient determinations.

Merits of Borosil Mansingh Survisometer :

- Fast and multipurpose technology
- Eco-friendly and user-friendly
- Reduces fabrication expenditure
- Reduces the need for glass blowing gases, oxygen gas, LPG and manpower
- Reduces emission of heat into the environment
- Ensures safety during transport and maintenance
- Reduces chemicals and solvents greatly
- Contributes to the promotion of green chemistry
- Innovative for youngsters
- No wastage of the sample
- Requires a smaller sample
- Less time required for analysis
- Requires no basic maintenance
- Non-destructive
- Reduces cleaning reagents
- Reduces the number of operational steps in measurement
- Minimises the infrastructure as compared to individual devices

Industrial Applications

Industries such as cosmetics, soaps and detergents, petroleum and oils, pesticides, beverages, textiles, paints, polymers and textiles, paper pulp, ink and dyes, medicines and drugs, food and mineral water, and coolants and lubricants will directly benefit from the use of Borosil Mansingh Survisometer.

Viscometer

3500-VISCOMETER COLLEGE PATTERN Oswal 80 -100 Seconds, Uncertified

Product Code	Size	Nominal Constant	Viscosity Range (CS)	Quantity Per Case	Price / Piece ₹
3500	○	0.001	0.3 - 3	10	1940.00

- Supplied without Certificate

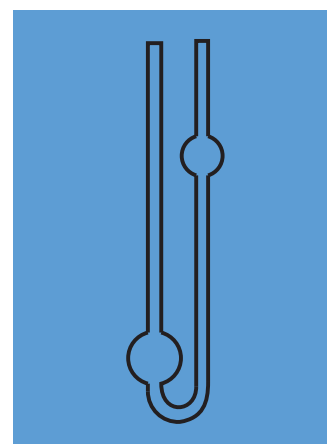

BOROSIL[®]

Glassware For Microbiology And Cell Culture

Glassware for
Microbiology &
Cell Culture

- ROUX BOTTLES
- HAFFKINE CULTURE FLASK
- PETRI DISHES
- GLASS SPREADER
- CULTURE COLLECTION TUBE
- CULTURE TUBES
- SAMPLING AND STORAGE VIALS
- ERLLENMEYER CULTURE FLASK
- MICROSCOPE SLIDES & COVER GLASS



Made from 3.3 Low Expansion
Borosilicate Glass

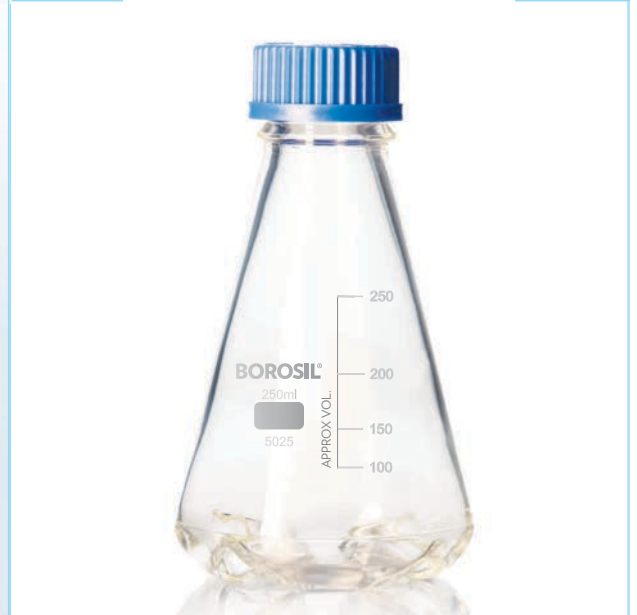
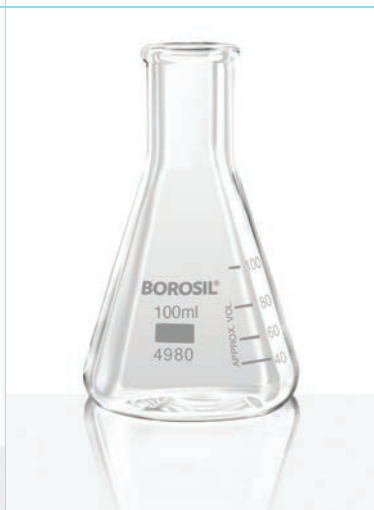

1290 - ROUX BOTTLES WITH OFF SET NECK

- Complies with IS 6942
- The offset neck is tool-finished for greater strength and uniform stopper fit
- Withstands repeated sterilisation cycles (wet or dry)
- These bottles facilitate the growing of mass cultures and monolayer cultures



Product Code	Capacity ml	Approx B x W x H mm	Approx Neck I. D. mm	Quantity Per Case	Price / Piece ₹
1290029	1000	126 x 56 x 265	25	20	1695.00

4422 - CULTURE FLASK

Haffikine

- Complies with IS 7183
- The large, flat bottom surface ensures uniform culture growth
- Typically used for the preparation of culture in nutrient media



Product Code	Capacity ml	Approx O.D. x Height mm	Quantity Per Case	Price / Piece ₹
4422031	3000*	245 x 280	2	2695.00
4422032	4000	246 x 310	2	3430.00

*3000 ml not covered in standards

Glassware for
Microbiology &
Cell Culture

BOROSIL®

Bottles for media preparation

Autoclavable at 121°C



PP Screw Caps

Autoclavable at 121°C

Withstand dry heat sterilisation upto 200°C



High temperature resistance screw cap



Proudly Made in India Since 1962

BOROSIL®

an ISO 9001: 2015 certified company | PRICES EXCLUSIVE OF TAXES | For products listed on this page use HSN code 70179090

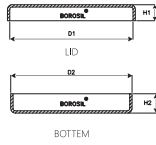

3160 - PETRI DISHES (3.3 Borosilicate)

- Made of 3.3 low expansion borosilicate glass
- Complies with IS 2626
- These dishes are clear and withstand repeated sterilisation cycles (wet or dry)
- Beaded edges impart greater mechanical strength
- Specially formed to ensure even wall thickness and consistent optical performance
- Ideal culture vessel for microbiology and plant tissue culture applications

Product Code	Size mm	LID Approx I.D. (D1) x Height (H1) mm	Bottom Approx O.D. (D2) x Height (H2) mm	Quantity Per Case	Price / Piece ₹
3160065	50 x 17	53 x 15	50 x 17	100	190.00
3160072	80 x 17	83 x 15	80 x 17	100	245.00
3160077	100 x 17#	103 x 15	100 x 17#	100	290.00
3160081	150 x 20	153 x 17	150 x 20	40	710.00
3160087	200 x 20	203 x 20	200 x 20	10	1530.00

Not covered in standard



Now Lid and Bottom identification is Easy

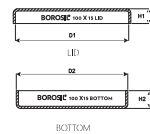

3165 - S LINE PETRI DISHES

- Made of sodalime glass
- **S-Line petri dishes with durable white enamel printing - with lid and bottom mentioned on it**
- Helps in quick identification of the lid and the bottom while sorting and pairing the petri dishes during use
- Optically clear and bubble free for making critical observations
- Flat inner surface for uniform distribution of media
- Ideal culture vessel for microbiology and plant tissue culture applications

Product Code	Size mm	LID Approx I.D. (D1) x Height (H1) mm	Bottom Approx O.D. (D2) x Height (H2) mm	Quantity Per Case	Price / Piece ₹
3165065	50 x 12	46 x 8	44 x 12	100	80.00
3165072	80 x 15	76 x 12	74 x 15	100	90.00
3165A75	90 x 15	86 x 12	84 x 15	100	90.00
3165077	100 x 15	96 x 12	94 x 15	100	95.00
3165A77	100 x 20	96 x 15	94 x 20	100	175.00
3165081	150 x 25	143 x 18	141 x 25	40	215.00
3165087	200 x 30	195 x 24	192 x 30	10	460.00

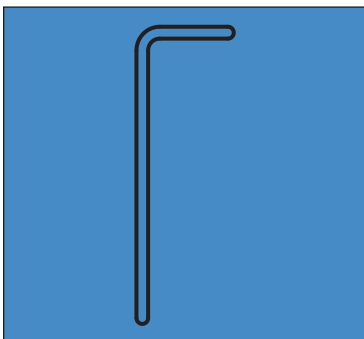

9865 - GLASS L SHAPED SPREADER **NEW**

- Made of 3.3 borosilicate glass
- Smooth glass surface hence no chances of agar layer disruption while spreading
- Easy to clean and autoclavable at 121°C
- Used for inoculating microbial cultures on agar plates

Product Code	Approx OD x Length mm	Quantity Per Case	Price / Piece ₹
9865683	6 x 150	100	50.00

9801 - TUBE FOR CULTURE COLLECTION

- Designed with a round bottom
- Thick walled and high mechanical resistance
- High thermal shock resistance
- Used for blood and microbial culturing

Product Code	Approx O.D. x Length mm	Quantity Per Case	Price / Piece ₹
9801U01	7 x 127	800	20.00

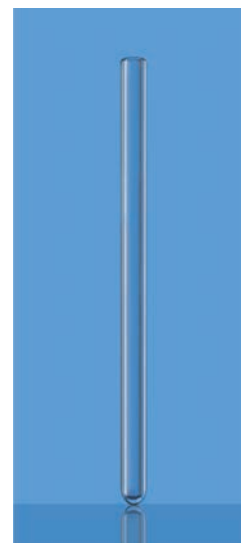

9900 - CULTURE TUBES

Round Bottom, Clear, With PP Cap

- Supplied with polypropylene cap and PTFE Liner (except 150 ml), autoclavable at 121°C
- Designed with special caps to facilitate handling and sealing
- The ideal replacement for media culture bottles



Product Code	Capacity ml	Approx O.D. x Length mm	Quantity Per Case	Price / Piece ₹
9900005	5	16 x 75	100	55.00
9900006	10	16 x 125	100	60.00
9900010	30	25 x 100	100	75.00
9900012	50	25 x 150	50	80.00
9900013	60	25 x 200	50	80.00
9900018	150#	38 x 200	50	335.00



Glassware for
Microbiology &
Cell Culture

All caps are Polypropylene with PTFE liner, except 150 ml

#Blue colour cap without PTFE liner & autoclavable up to 140°C

9901 - CULTURE TUBES

Round Bottom, Amber, With PP Cap

- Supplied with polypropylene cap and PTFE Liner (except 150 ml), autoclavable at 121°C
- The uniform amber colour is highly durable and protects light sensitive media and solutions
- Designed with special caps to facilitate handling and sealing
- The ideal replacement for media culture bottles



Product Code	Capacity ml	Approx O.D. x Length mm	Quantity Per Case	Price / Piece ₹
9901005	5	16 x 75	100	100.00
9901006	10	16 x 125	100	130.00
9901010	30	25 x 100	100	145.00
9901013	60	25 x 200	50	190.00
9901018	150#	38 x 200	50	850.00



All caps are Polypropylene with PTFE liner, except 150 ml

#Blue colour cap without PTFE liner & autoclavable up to 140°C



9910 - CULTURE TUBE

Flat Bottom, Clear, With PP Cap

- Supplied with polypropylene cap and PTFE Liner (except 150 ml), autoclavable at 121°C
- Designed with flat bottom for convenient storage and special caps to facilitate handling and sealing
- The ideal replacement for for Bijou, Mc Cartney and universal bottles

Product Code	Capacity ml	Approx O.D. x Length mm	Quantity Per Case	Price / Piece ₹
9910005	5	16 x 50	100	50.00
9910006	10	25 x 50	100	65.00
9910007	15	25 x 57	100	65.00
9910008	20	25 X 72	100	70.00
9910010	30	25 x 95	100	75.00
9910012	50	25 x 145	50	80.00



9911 - CULTURE TUBE

Flat Bottom, Amber, With PP Cap

- Supplied with polypropylene cap and PTFE Liner (except 150 ml), autoclavable at 121°C
- The uniform amber colour is highly durable and protects light sensitive media and solutions
- Designed with flat bottom for convenient storage and special caps to facilitate handling and sealing
- The ideal replacement for for Bijou, Mc Cartney and universal bottles

Product Code	Capacity ml	Approx O.D. x Length mm	Quantity Per Case	Price / Piece ₹
9911005	5	16 x 50	100	100.00
9911006	10	25 x 50	100	135.00
9911007	15	25 x 57	100	135.00
9911008	20	25 x 72	100	160.00
9911010	30	25 x 95	100	170.00

9913 - SAMPLING & STORAGE VIALS

- Made of 5.1 expansion borosilicate glass conforming to USP type I, ASTM E438
- Supplied with high quality polypropylene cap with a PTFE liner, autoclavable at 121°C
- Write on patch for easy labelling and identification
- Complies glass composition and spectral transmission test as per USP chapter 660 USP 40 and EP 9.0
- Packed in ISO "Class 8" clean room facility
- Amber colour protects light sensitive materials
- Ideal for storage of working standards, sampling of raw materials, chemical and biological samples



Product Code	Capacity ml	Approx Mouth ID in mm	Dimension O.D. x Length in mm	Case Lot (MOQ)	Price Per Piece ₹
9913003	3	10	16 x 36	1050	30.00
9913005	5	10	16 x 55	1050	35.00
9913006	10	16.5	24 x 50	600	50.00
9913007	15	16.5	24 x 58	600	55.00
9913008	20	16.5	24 x 70	600	70.00
9913010	30	16.5	24 x 95	600	80.00

Glassware for
Microbiology &
Cell Culture

4980 - ERLLENMEYER (CONICAL) FLASK

Narrow Mouth, With Rim

- Complies with IS 1381(Part I), DIN / ISO 1773
- Uniform wall thickness distribution makes these flasks ideal for heating
- The conical form makes them suitable for mixing liquids
- The easy-to-read scale and large labelling field facilitates easy marking
- Graduated from 25 ml to 5000 ml

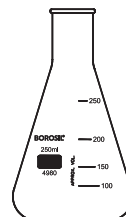

Product Code	Capacity ml	Approx O.D. x Height mm	Approx Neck O.D. mm	Quantity Per Case	Price / Piece ₹
4980006	10*	37 x 60	15	30	85.00
4980009	25	42 x 75	22	40	90.00
4980012	50	51 x 90	22	100	90.00
4980016	100	64 x 105	22	100	95.00
4980017	125*	66 x 110	28	100	110.00
4980018	150*	72 x 124	28	100	115.00
4980021	250	85 x 145	34	40	140.00
4980024	500	105 x 180	34	40	200.00
4980029	1000	131 x 220	42	20	340.00
4980030	2000	166 x 280	52	20	590.00
4980031	3000	187 x 310	50	4	1590.00
4980033	5000	220 x 365	50	2	2615.00

25 ml to 5000 ml Graduated

*Not covered in standards

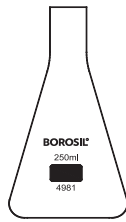

4981 - ERLLENMEYER (CONICAL) FLASK

Long Neck Without Rim

- Complies with IS 1381(Part I), DIN / ISO 1773
- Uniform wall thickness distribution makes these flasks ideal for heating
- Long neck designed for cotton plugs and metal caps
- The conical form makes them suitable for mixing liquids
- The easy-to-read scale and large labelling field facilitate easy marking
- Ideal for microbial culture work

Product Code	Capacity ml	Approx O.D. x Height mm	Approx Neck O.D. mm	Quantity Per Case	Price / Piece ₹
4981021	250	78 x 154	27	10	190.00



5021 - ERLLENMEYER (CONICAL) FLASK

With Screw Cap

- Supplied with screw cap made of polypropylene, autoclavable at 121°C
- The conical form makes them suitable for mixing of liquids
- Ideal for microbial and cell culture work

Product Code	Capacity ml	Neck Specification	Quantity Per Case	Price / Piece ₹
5021016	100	GL 25	20	265.00
5021018	150	GL 25	20	300.00
5021021	250	GL 45	20	350.00
5021024	500	GL 45	10	430.00
5021029	1000	GL 45	10	830.00
5021030	2000	GL 45	10	1185.00
5021033	5000	GL 45	2	5570.00

5025 - ERLLENMEYER (CONICAL) FLASK

Baffled Bottom, With Screw Cap

- Supplied with screw cap made of polypropylene, autoclavable at 121°C
- Exhibits four baffled indents to provide consistent agitation and optimum aeration
- Optimum clarity for making critical observations
- Chemically inert and resistance to sodium leaching does not cause any pH changes in the liquid it is holding
- Ideal culture vessel for microbial culture preparations, enzymatic dissociation of tissues, culturing of suspension cells for biopharma applications, plant cell culturing



Product Code	Capacity ml	Neck Specification	Quantity Per Case	Price / Piece ₹
5025021	250	GL 45	20	1950.00
5025024	500	GL 45	10	2380.00
5025029	1000	GL 45	10	3350.00
5025030	2000	GL 45	10	4110.00

BOROSIL®

Flasks

Made of borosilicate glass

Ideal for Microbial culture work



Proudly Made in India Since 1962

Glassware for
Microbiology &
Cell Culture

Microscope Slides & Cover Glasses

Conforms to ISO 8037 standard

- Fine ground edges slide are manufactured by state-of-art manufacturing process which results in a high quality and polished ground edges.
- Refractive index of 1.53 ± 0.02
- From extremely uniform, thin and flat glass sheets which are very resistant to corrosion and fogging.
- The slide is used for routine microscopy application.



9100 - MICROSCOPE GLASS SLIDES

- Made from the finest white glass of uniform quality
- Conforms to ISO 8037 standard
- High- precision ground edges on all four sides
- Thin, flat and resistant to corrosion or fogging
- Pre-cleaned and ready to use
- Subjected to strict quality control checks, examined individually and environmentally controlled dry before packaging
- Specially designed for meeting the stringent needs of users
- Free from all visual defects
- Used for routine microscopy applications



Product Code	Description	Dimensions mm L x B x WT	Quantity Per Packet No.	Packets / Case	Price / Packet ₹
9100P02	Plain, Ground Edges	76 x 26 x 1	50	25	170.00
9100D01	Double Frosted, Ground Edges	76 x 26 x 1	50	25	240.00

L : Length x B : Breadth x WT : Wall Thickness

9115 - COVER GLASS

- Made from the finest white glass of uniform quality
- Available in both square and rectangular shape
- Cover glass is cut, cleaned, sorted and weighed
- Resistance to corrosion and fogging
- Free from ragged edges, oily film and finger prints
- Packed in reclosable plastic boxes for protection during storage
- Pre cleaned and ready to use
- Subjected to strict quality control checks, examined individually and environmentally controlled to dry before packaging

Product Code	Description	Dimensions mm	Quantity Per Packet / Piece	Packets / Case	Price / Packet ₹
9115S01	Square	18 x 18	100	50	250.00
9115S02	Square	22 x 22	100	50	375.00
9115S03	Square	24 x 24	100	50	420.00
9115R01	Rectangular	22 x 40	100	50	600.00
9115R02	Rectangular	22 x 50	100	50	700.00
9115R03	Rectangular	22 x 60	100	50	815.00

9115S01 - SQUARE



9115S02 - SQUARE



9115S03 - SQUARE



9115R01 - RECTANGULAR



9115R02 - RECTANGULAR



9115R03 - RECTANGULAR



Glassware for
Microbiology &
Cell Culture

BOROSIL®

BORO PURE

Filtration System

Filtration
Products



- GLASS FILTRATION ASSEMBLY
- FILTER MEMBRANES

BOROSIL® offers a complete solution for laboratory filtration applications with **BORO PURE** range of products

BORO PURE Glass Filter Assembly is easy to clean and 100% autoclavable and reusable. It is made of 3.3 borosilicate glass with a sintered glass filter which is compatible with most of the organic solvents. All glass filter assembly is an environment friendly and cost effective device for filtration.

BORO PURE Filter membranes is a new offering which includes membrane for applications such as HPLC mobile phase filtration, analysis of particulate or biological contaminants, small volume filtration and sterile filtration of media and buffer.



Made from 3.3 Low Expansion Borosilicate Glass





5350 - BOROPURE GLASS FILTRATION ASSEMBLY

- Available in two sizes - 47 mm and 90 mm
- Entire assembly consists of:
 1. Glass Funnel - Capacity: 300 ml / 1000 ml
 2. Filter Support Base with sintered glass filter - 47 mm/ 90 mm
 3. Glass Receiver Flask - 500 ml/1000 ml/2000 ml/5000 ml
 4. Aluminium Clamp - 47 mm / 90 mm
- Effective filtration area - 9.6 cm² for 47 mm and 45.5 cm² for 90 mm
- The filter support base design has an integral vacuum connection located above the filtrate drip to prevent contamination of the vacuum line from droplets
- Aluminium spring clamp is anodised for longer life
- Ideal for filtration of HPLC solvents and aqueous mobile phase solutions and buffers

Assembly

Product Code	Filter Support Base Size mm	Glass Funnel Capacity ml	Glass Receiver Flask Capacity ml	Aluminium Clamp mm	Quantity Per Case	Price / Piece ₹
5350024	47	300 ml	500	47	1	14370.00
5350029	47	300 ml	1000	47	1	14875.00
5350030	47	300 ml	2000	47	1	19540.00
5350033	90	1000 ml	5000 ml	90	1	On request
5350A29	90	1000 ml	1000 ml	90	1	On request

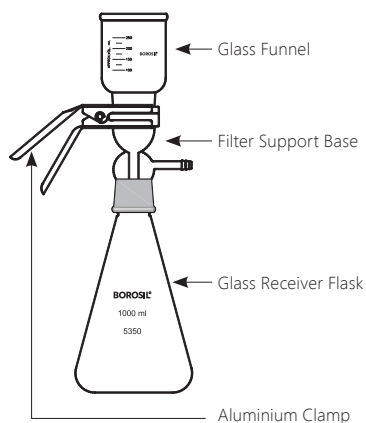

Spares For 47 MM Filter Assembly

Product Code	Capacity / Size	Description	Price / Piece ₹
5350124	500 ml	Glass Receiver Flask	2845.00
5350129	1000 ml	Glass Receiver Flask	4180.00
5350130	2000 ml	Glass Receiver Flask	9305.00
5350S01	300 ml	Glass Funnel	3790.00
5350S02	47 mm	Filter Support Base	4850.00
5350S03	47 mm	Aluminium Clamp	3090.00

Spares For 90 MM Filter Assembly

Product Code	Capacity / Size	Description	Price / Piece ₹
5350133	5000 ml	Glass Receiver Flask	On request
5350229	1000 ml	Glass Receiver Flask	On request
5350233	1000 ml	Glass Funnel	On request
5350333	90 mm	Filter Support Base	On request
5350433	90 mm	Aluminium Clamp	On request

HSN Code: 70179090 (for Assembly as well as spares)

5360 - BOROPURE GLASS FILTRATION ASSEMBLY

With Silicone Stopper, 47 mm

- Entire assembly consists of:
 - Glass Funnel - Capacity: 300 ml
 - Filter Support Base with sintered glass filter - 47 mm
 - Glass Receiver Flask - 1000 ml / 2000 ml
 - Aluminium Clamp - 47 mm
 - Silicone stopper: size # 8
- Effective filtration area - 9.6 cm² for 47 mm
- The filter support base design has an integral vacuum connection located above the filtrate drip to prevent contamination of the vacuum line from droplets
- Aluminium spring clamp is anodised for longer life
- The filtration base has a silicon stopper
- Facilitates analysis of particulate or biological contamination of vacuum filtering liquid

Assembly

Product Code	Filter Support Base Size mm	Glass Funnel Capacity ml	Glass Receiver Flask Capacity ml	Aluminium Clamp mm	Silicone stopper Size	Quantity Per Case	Price / Piece ₹
5360029	47	300 ml	1000	47	#8	1	13985.00
5360030	47	300 ml	2000	47	#8	1	16045.00

Spares For 47 MM Filter Assembly

Product Code	Capacity / Size	Description	Price / Piece ₹
5360129	1000 ml	Glass Receiver Flask	4065.00
5360130	2000 ml	Glass Receiver Flask	5680.00
5350S01	300 ml	Glass Funnel	3790.00
5360S02	47 mm	Filter Support Base	4960.00
5350S03	47 mm	Aluminium Clamp	3090.00
5360S04	#8	Silicone stopper, MOQ - Pack of 10 nos	335.00

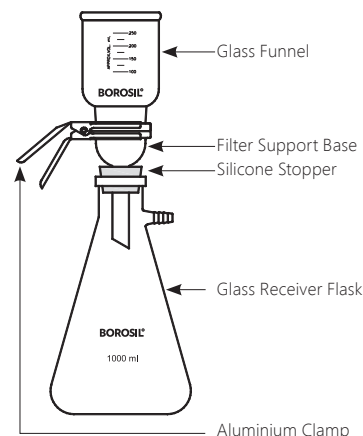

Filtration Products



5370 - BOROPURE GLASS MICROFILTRATION ASSEMBLY

With Silicone Stopper, 25 mm

- Entire assembly consists of:
 1. Glass Funnel - Capacity: 15 ml
 2. Filter Support Base with sintered glass filter - 25 mm
 3. Glass Receiver Flask - 125 ml
 4. Aluminium Clamp - 25 mm
 5. Silicone stopper: size #5
- Effective filtration area - 2.2 cm² for 25 mm
- The filter support base design has an integral vacuum connection located above the filtrate drip to prevent contamination of the vacuum line from droplets
- Aluminium spring clamp is anodised for longer life
- The filtration base has a silicon stopper
- Ideal for small volume vacuum filtration for biological analysis or particulate contamination analysis.

Assembly

Product Code	Filter Support Base Size mm	Glass Funnel Capacity ml	Glass Receiver Flask Capacity ml	Aluminium Clamp mm	Silicone stopper Size	Quantity Per Case	Price / Piece ₹
5370017	25	15 ml	125	25	#5	1	7080.00

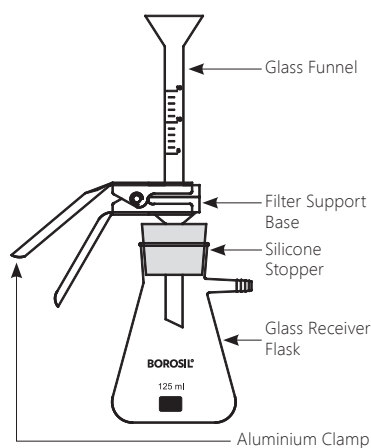

Spares For 25 MM Filter Assembly

Product Code	Capacity / Size	Description	Price / Piece ₹
5370S01	125 ml	Glass Receiver Flask	2845.00
5370S02	15 ml	Glass Funnel	1730.00
5370S03	25 mm	Filter Support Base	3960.00
5370S04	25 mm	Aluminium Clamp	2175.00
5370S05	#5	Silicone stopper, MOQ - Pack of 10 nos	275.00

5380 - BOROPURE GLASS FILTRATION ASSEMBLY 47 mm, With Bottle

NEW

- Entire assembly consists of:
 - Glass Funnel - Capacity: 300 ml / 1000 ml
 - Filter Support Base with sintered glass filter - 47 mm / 90 mm
 - Glass Bottle with PP Screw cap - 1000 ml / 2000 ml / 5000 ml
 - Aluminium Clamp - 47 mm / 90 mm
- Effective filtration area - 9.6 cm² for 47 mm and 45.5 cm² for 90 mm
- The filter support base design has an integral vacuum connection located above the filtrate drip to prevent contamination of the vacuum line from droplets
- Aluminium spring clamp is anodised for longer life
- The final filtrate will be collected directly in a screw cap bottle and there is no need to transfer the filtrate again into a new container for storage
- Ideal for filtration of HPLC solvents and aqueous mobile phase solutions, sterile filtration of media and buffers

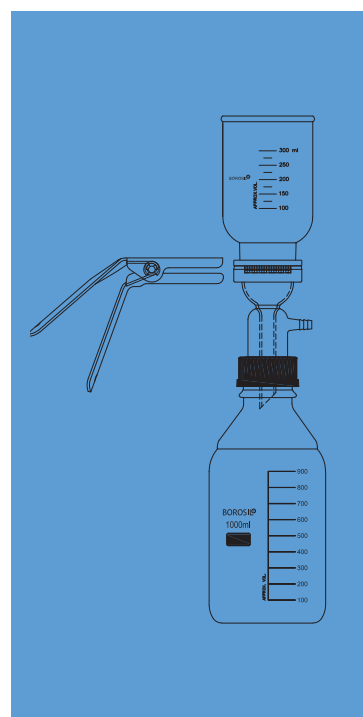

Assembly

Product Code	Filter Support Base Size mm	Glass Funnel Capacity ml	Glass Receiver Bottle Capacity ml	Aluminium Clamp mm	Quantity Per Case	Price per set ₹
5380029	47	300 ml	1000	47	1	12875.00
5380030	47	300 ml	2000	47	1	14875.00
5380033	90	1000 ml	5000	90	1	On request

Spares For 47 MM Filter Assembly

Product Code	Capacity / Size	Description	Price / Piece ₹
5380129	1000 ml	Glass Receiver Bottle with GL 45 screw cap	4180.00
5380130	2000 ml	Glass Receiver Bottle with GL 45 screw cap	7500.00
5350S01	300 ml	Glass Funnel	3790.00
5380S02	47 mm	Filter Support Base	6065.00
5350S03	47 mm	Aluminium Clamp	3090.00

Spares For 90 MM Filter Assembly

Product Code	Capacity / Size	Description	Price / Piece ₹
5380133	5000 ml	Glass Receiver Bottle with GL 45 screw cap	On request
5350233	1000 ml	Glass Funnel	On request
5380333	90 mm	Filter Support Base	On request
5350433	90 mm	Aluminium Clamp	On request



5147 - BOROPURE CELLULOSE NITRATE MEMBRANE **NEW**

- Hydrophilic in nature and biologically inert
- High retention and high flow rate
- Available in two pore sizes - 0.22 micron and 0.45 micron
- Autoclavable at 121°C for 30 mins for sterilization
- Recommended for applications like clarification and sterilization of media, reagents and buffers, sterility testing, water testing, product and water microbiology
- Tested for : Membrane integrity, Flow rate, Membrane thickness, Heat stability and Microbial Challenge Test

Product Code	Description	Pore size μm	Diameter mm	Membrane /pack Nos	Price per pack ₹
514722N	Cellulose Nitrate Membrane, Non- sterile	0.22	47	100	1450.00
514745N	Cellulose Nitrate Membrane, Non- sterile	0.45	47	100	1450.00



5247 - BOROPURE GRIDDED CELLULOSE NITRATE MEMBRANE **NEW**

- Hydrophilic in nature and biologically inert
- High retention and high flow rate
- White membrane with black grids which make the colony counting easier
- Grids do not inhibit the growth of microorganisms
- Available in two pore sizes - 0.22 micron and 0.45 micron
- Autoclavable at 121°C for 30 mins for sterilization
- Recommended for applications like water testing, product and water microbiology
- Tested for : Membrane integrity, Flow rate, Membrane thickness, Heat stability , Microbial Challenge Test and Growth Inhibition

Product Code	Description	Pore size μm	Diameter mm	Membrane /pack Nos	Price per pack ₹
524722N	Gridded Cellulose Nitrate Membrane, Non- sterile	0.22	47	100	1600.00
524745N	Gridded Cellulose Nitrate Membrane, Non- sterile	0.45	47	100	1600.00



5347 - BOROPURE NYLON-66 MEMBRANE **NEW** HPLC Grade

- Hydrophilic in nature and biologically inert
- Wide chemical compatibility and resistant to strong solvents and alcohols
- Available in two pore sizes - 0.22 micron and 0.45 micron
- Autoclavable at 121°C for 30 mins for sterilization
- Recommended for applications like clarification of aqueous and organic HPLC mobile phase solvents, HPLC sample preparations
- Tested for : Membrane integrity, Flow rate, Membrane thickness, Heat stability, Fibre/ particle release and Extractables

Product Code	Description	Pore size μm	Diameter mm	Membrane /pack Nos	Price per pack ₹
534722N	Nylon-66 Membrane, Non- sterile	0.22	47	100	1675.00
534745N	Nylon-66 Membrane, Non- sterile	0.45	47	100	1675.00

For membranes of other diameter and pore sizes, please contact our local sales representative

BOROSIL[®]

Vacuum Pump - Oil Free

- BORO - 017 vacuum pump is a piston-powered, oil-free pump. With innovative electronic, mechanical technology and human design concept make, compact and light weight, clean and maintenance free, safe and comfortable.
- BORO - 017 vacuum pump are driven by Piston, without the need of lubricant, regular oil changes and maintenance; with no oil pollution
- BORO - 017 vacuum pump are equipped with filter cartridge in air inlet to filter particle and moisture to prolong the life of pump.
- BORO - 017 vacuum pump are equipped with vacuum regulator to adjust vacuum.
- Every motor of BORO - 017 vacuum pump has a built in thermal protection device to shut off the pump automatically when overheated and then resume working when the temperature cools down.



Application areas :

- Biology Laboratories
- Food Industry
- Liquid filtration
- Microbiological detection
- Suspended solids measurement
- Vacuum drying
- Vacuum extraction

Filter Membrane Chemical Compatibility Chart					
Name of the chemical	Nylon - 66	PTFE	PVDF	PES	Cellulose Nitrate
Acids					
Acetic, 10%	C	C	C	C	C
Boric, 5%	L	C	C	C	C
Hydrochloric, 25%	L	C	C	C	N
Hydrochloric, Concentrated	N	L	L	C	N
Sulfuric, 25%	N	C	C	C	C
Sulfuric, Concentrated	N	N	L	N	N
Nitric, 25%	N	L	L	L	C
Nitric, Concentrated	N	L	L	N	N
Phosphoric acid, 25%	N	C	–	C	L
Bases					
Potassium hydroxide, 6N	C	C	–	C	N
Sodium Hydroxide, 3N	C	C	C	C	N
Ammonium Hydroxide, 25%	C	C	L	C	N
Alcohols					
Amyl Alcohol	C	C	C	C	–
Benzyl Alcohol	L	C	C	N	L
Butyl Alcohol	C	C	–	C	–
Ethanol, 70%	C	C	C	C	N
Ethanol, 98%	C	C	C	L	N
Ethylene Glycol	C	C	C	C	–
Glycerol	L	C	–	C	L
Isopropanol	C	C	C	C	L
Methanol, 98%	C	C	C	C	N
n-Propanol	C	C	C	C	–
Propylene Glycol	C	C	C	C	–
Hydrocarbons					
Benzene	C	C	C	N	C
Hexane Xylene	C	C	C	N	C
Kerosene Gasoline	C	C	C	L	–
Tetralin, Decalin	C	C	C	N	–
Toluene	C	C	C	N	C
Halogenated Hydrocarbons					
Carbon Tetrachloride	C	C	C	N	C
Chlorobenzene (Mono)	C	C	C	L	–
Chloroform	L	C	C	N	N
Freon	C	C	C	L	–
Methylene Chloride	L	C	C	N	–

C = Compatible
 N = Not compatible
 L = Limited Compatibility
 – = No data available

The information in this chart is to be used ONLY as a guide in selecting membrane for appropriate chemical compatibility. ALWAYS test under the specific conditions of your application before use.

Filter Membrane Chemical Compatibility Chart					
Name of the chemical	Nylon - 66	PTFE	PVDF	PES	Cellulose Nitrate
Trichloroethane	C	C	C	N	L
Trichloroethylene	C	C	C	N	L
Ketones					
Acetone	C	C	N	N	N
Cyclohexanone	C	C	N	N	C
Isopropylacetone	C	C	N	N	N
Methyl Ethyl Ketone	C	C	N	N	–
Methyl Isobutyl Ketone (MIBK)	C	C	N	N	–
Esters					
2-Ethoxyethyl Acetate	L	L	L	N	–
Amyl Acetate	C	C	C	N	N
Benzyl Benzoate	C	C	–	N	–
Butyl Acetate	C	C	C	N	N
Ethyl Acetate	C	C	C	N	N
Isopropyl Myristate	C	C	–	N	–
Methyl Acetate	L	C	L	N	–
Propyl Acetate	L	N	C	N	–
Propylene Glycol Acetate	L	C	–	N	–
Methyl Cellosolve Acetate	C	C	C	N	–
Tricresyl Phosphate	–	C	–	N	–
Oxides — Ethers					
Acetonitrile (Methyl Cyanide)	C	C	C	N	N
Aniline	L	C	C	N	–
Diethyl Acetamide	C	C	C	–	–
Dimethyl Formamide	C	C	N	N	N
Dimethyl Sulfoxide (DMSO)	C	C	C	N	N
Dioxane	C	C	L	N	–
Ethyl Ether	C	C	C	C	–
Isopropyl Ether	C	C	N	C	–
Pyridine	C	C	L	N	–
Solvents with Nitrogen					
Tetrahydrofuran	C	C	L	N	–
Triethanolamine	C	C	C	–	–
Miscellaneous					
Formaldehyde Solution, 30%	C	C	C	C	–
Hydrogen Peroxide, 30%	N	C	C	C	–
Phenol, Aqueous, 10%	N	C	L	N	–
Silicone Oil & Mineral Oil	C	C	C	C	–

C = Compatible
 N = Not compatible
 L = Limited Compatibility
 – = No data available

The information in this chart is to be used ONLY as a guide in selecting membrane for appropriate chemical compatibility. ALWAYS test under the specific conditions of your application before use.

BOROSIL[®]

Laboratory Accessories

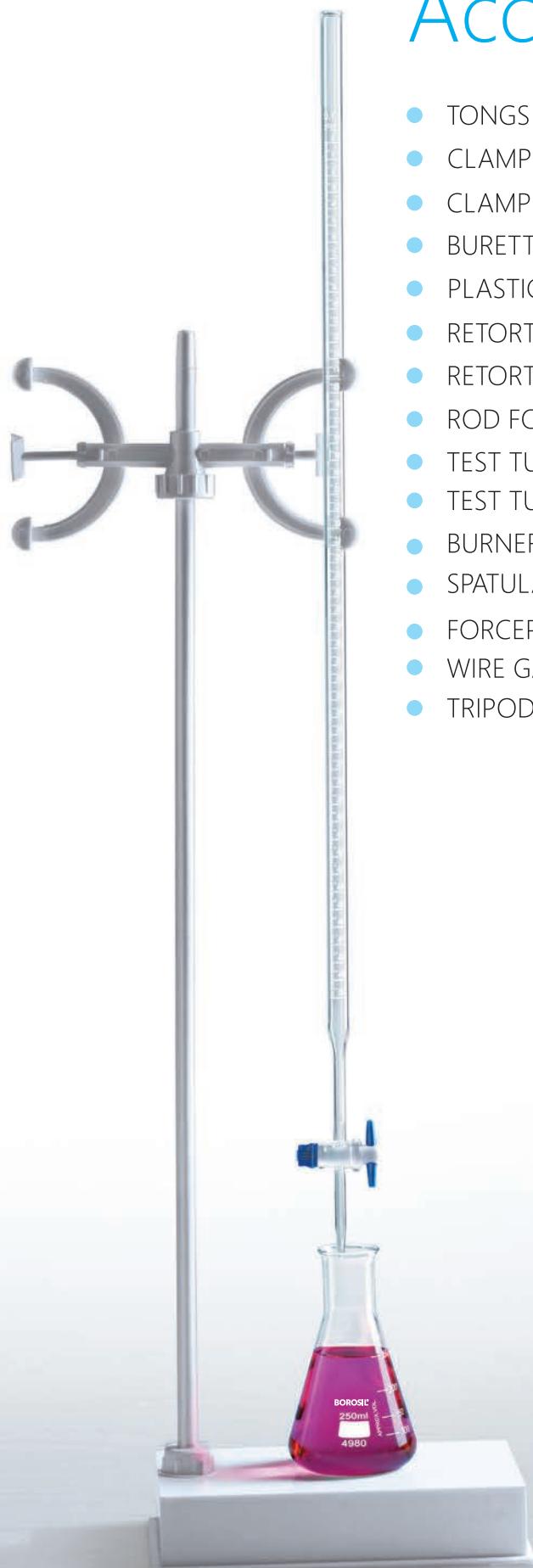

- TONGS
- CLAMPS
- CLAMP WITH BOSSHEADS
- BURETTE CLAMPS
- PLASTIC CLAMPS FOR JOINTS
- RETORT RING
- RETORT BASE
- ROD FOR RETORT BASE
- TEST TUBE STAND
- TEST TUBE HOLDER
- BURNER
- SPATULAS
- FORCEPS
- WIRE GAUGE
- TRIPOD

TONGS FOR BEAKERS & FLASKS

- Made of stainless steel
- Used to handle hot beakers & flasks
- Provided with silicon sleeves or in fibre glass yarn to resist direct flame

Product Code	Description	Size Inches	Case Lot No.	Price / Piece ₹
LATG8888B10	Beaker tong	10	6	340.00
LATG8888B12	Beaker tong	12	6	450.00
LATG8888F10	Flask tong	10	6	430.00
LATG8888F12	Flaks tong	12	6	535.00



TONGS FOR CRUCIBLE

- Made of Stainless Steel
- Used to handle hot crucibles

Product Code	Description	Size Inches	Case Lot No.	Price / Piece ₹
LACT8888006	Crucible tong with bow stainless steel	6	6	170.00
LACT8888008	Crucible tong with bow stainless steel	8	6	215.00
LACT8888010	Tong crucible, SS,	10	6	295.00
LACT8888012	Crucible tong with bow stainless steel	12	6	395.00



CLAMPS

- Available in Zinc & Aluminium diecasted
- It is coated with LEAD-FREE powder coating & fitted with brass screw which makes it totally RUST-FREE CLAMP
- Two & three finger clamp Jaws can be covered with PVC sleeves
- Two & four finger clamp has cork lined Jaws holds upto 90 mm articles
- It is provided with 8 mm diameter & 150 mm long Stainless Steel(Grade 201)rod

Product Code	Description	Case Lot No.	Price / Piece ₹
LAFC8888Z02	Two finger clamp, Zinc pressure die casted	10	340.00
LAFC8888AD3	Three finger clamp, Aluminum pressure die casted	10	395.00
LAFC8888ZD4	Four finger clamp, Zinc pressure die casted	10	340.00
LAFC8888AD4	Four finger clamp Aluminum pressure die casted	10	360.00





CLAMPS WITH BOSSHEAD

- Available in Zinc & Aluminium diecasted
- It is coated with LEAD-FREE powder coating & fitted with brass screw which makes it totally RUST-FREE CLAMP
- Two & three finger clamp Jaws can be covered with PVC sleeves
- Two & four finger clamp has cork lined Jaws holds upto 90 mm articles
- With adjustable bosshead attached clamp length can be vary, can be rotated 360° and locked at any angle

Product Code	Description	Case Lot No.	Price / Piece ₹
LAFC8888Z03	Two finger clamp (Zinc PDC) with adjustable bosshead	12	615.00
LAFC8888A03	Three finger clamp (Aluminium PDC) with adjustable bosshead	12	615.00
LAFC8888Z04	Four finger clamp (Zinc PDC) with adjustable bosshead	12	675.00
LAFC8888A04	Four finger clamp (Aluminium PDC) with adjustable bosshead	12	705.00



UNIVERSAL CLAMPS

- Single Burette / Test Tube Clamp made of stainless steel Jaws & Aluminium bosshead
- Round jaws are covered with PVC coating
- Opens from 15 mm to 45 mm in Diameter
- Clamps attaches to rods up to 13 mm in diameter. Threaded rod and wing nut adjust clamp angle and overall length from 13 cm to 15 cm

Product Code	Description	Case Lot No.	Price / Piece ₹
LABC8888SC1	Single Burette clamp, PVC coated jaws stainless steel	12	450.00
LABC8888S01	Single Burette clamp, PVC uncoated jaws, stainless steel	12	395.00



BURETTE CLAMPS

- Single / Double Burette clamp is made of Aluminum die casting
- Feature black PVC sleeves for firm gripping of burettes.
- This adjustable burette clamp is suitable for all burettes up to 100 ml which are held in place by the high pressure created by the springs yet allows easy operations without damaging the glassware

Product Code	Description	Case Lot No.	Price / Piece ₹
LABC8888B01	Single burette clamp, Aluminium PDC Fig. A	6	675.00
LABC8888A02	Double burette clamp, Aluminium PDC Fig. B	6	675.00
LABC8888AE1	Single burette clamp, Aluminium PDC (Eco.) Fig. C	6	340.00
LABC8888AE2	Double burette clamp, Aluminium PDC (Eco.) Fig. D	6	450.00

BOSSHEADS

- Bosshead made of Zinc & Aluminum pressure die casted
- It can hold a rod upto 16 mm diameter at 90° angle and Swivel bosshead rotate at 360° angle
- It is coated with LEAD-FREE powder coating & fitted with Nickel plated thumb screw

Product Code	Description	Case Lot No.	Price / Piece ₹
LABH8888RBL	Regular bosshead Zinc PDC Fig. A	12	170.00
LABH8888OBL	Round bosshead Zinc PDC Fig. B	12	215.00
LABH8888JBL	Jumbo bosshead Aluminum PDC Fig. C	12	450.00
LABH8888SBL	Swivel bosshead Zinc PDC Fig. D	12	300.00

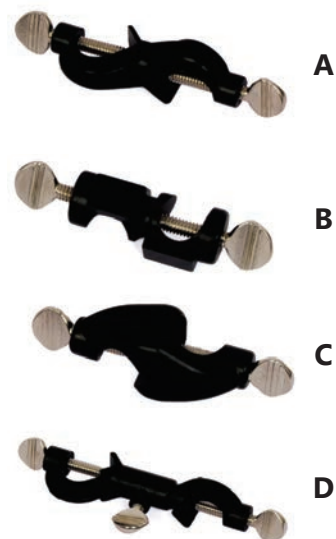

RETORT RING

- Strong circular mild steel ring with 6 mm diameter stem
- Open bosshead fitted with thumb screw to accept rods from 8 mm to 15 mm diameter

Product Code	Description	Size in Inches	Case Lot No.	Price / Piece ₹
LARR8888003	Retort Ring with bosshead	3	6	280.00
LARR8888004	Retort Ring with bosshead	4	6	350.00



RETORT BASE

- Superior Heavy duty steel alloy stand with rubber lining on a shorter side gives extra stability
- With lead-free powder coating

Product Code	Description	Size Inches	Case Lot No.	Price / Piece ₹
LARB8888H06	Retort base, Heavy	6" x 4"	6	615.00
LARB8888H08	Retort base, Heavy	8" x 5"	6	730.00
LARB8888H10	Retort base, Heavy	10" x 6"	6	1230.00



ROD FOR RETORT BASE

- With stainless steel Grade 201

Product Code	Description	Approx O.D. x Height mm	Case Lot No.	Price / Piece ₹
LARS8888500	Retort Rod (SS Grade 201)	12 x 500	2	430.00
LARS8888600	Retort Rod (SS Grade 201)	12 x 600	2	520.00
LARS8888750	Retort Rod (SS Grade 201)	12 x 750	2	595.00





TEST TUBE STAND

- It is made of Aluminum sheet, Z type, new design, single piece fabrication
- One row of holes of 30 mm diameter, the second row of holes of 25 mm diameter and third row of hole of 16 mm diameter
- This aluminium Z shape design is Coated with lead free powder coating make it corrosion resistant

Product Code	Description	Case Lot No.	Price / Piece ₹
LATS8888H19	Z' Shape Test Tube Stand, Aluminum, 19 hole assorted	6	450.00
LATS8888H25	'Z' Shape Test tube stand, 25 hole for 16mm tube	6	450.00



TEST TUBE HOLDER

- A pair of spring strip of hard rolled stainless steel, mounted in wooden handle in cross-scissor shape, and accepts tubes of diameter 12-43 mm.
- Overall length about 225mm

Product Code	Description	Case Lot No.	Price / Piece ₹
LATH8888000	Test tube holder, cross pattern, Stainless steel	24	195.00



BURNERS

- Bunsen Burner 13mm/11mm ideal for use with natural gas and L.P.G.
- Nickel-plated brass burner tube with Rotatable air regulator
- Enamelled Zinc pressure die casted base
- Base diameter 80 mm

Product Code	Description	Case Lot No.	Price / Piece ₹
LABR8888Z11	Bunsen burner, Zinc PDC base with 11 mm brass pipe for L.P.G. Fig. A	2	845.00
LABR8888Z13	Bunsen burner, Zinc PDC base with 13 mm brass pipe for L.P.G. Fig. B	2	845.00
LABR8888013	Burner, sheet metal base with 13 mm pipe, for L.P.G. Fig. C	2	675.00



PLASTIC CLAMPS FOR JOINT FITTINGS

- Made of polypropylene for joint fittings

Product Code	Joint mm	Quantity Per Case	Price / Piece ₹
1665B14	B 14	10	55.00
1665B19	B 19	10	55.00
1665B24	B 24	10	60.00
1665B29	B 29	10	60.00

SPATULAS

- Made of stainless steel grade 202
- Spatulas are used for measuring solids moving objects and scraping material out of beakers

Product Code	Description	Size in Inches	Case Lot No.	Price / Piece ₹
LACS8888006	Chattaway Spatula	6	20	70.00
LACS8888008	Chattaway Spatula	8	20	80.00
LASL8888C08	Micro Chattaway Spatula	8	20	75.00
LASC8888M06	Micro Scoop	6	10	60.00
LASC8888SM6	Semi Micro Spatula	6	10	90.00
LASL8888075	Big Spoon Spatula	7.5	10	130.00
LASL8888009	Big Spoon Spatula	9	10	145.00
LASP8888B06	Both side flat	6	20	75.00
LASP8888B08	Both side flat	8	20	100.00
LASP8888004	One end flat and one end Spoon	4	50	55.00
LASP8888006	One end flat and one end Spoon	6	50	60.00
LASP8888008	One end flat and one end Spoon	8	50	90.00
LASP8888010	One end flat and one end Spoon	10	50	135.00
LASP8888012	One end flat and one end Spoon	12	50	160.00
LASO8888W04	Ointment Spatula	4	10	170.00
LASO8888W06	Ointment Spatula Wooden Handle	6	10	185.00
LATG8888S06	Ointment Spatula Forged Stainless Steel	6	10	370.00
LASL8888P06	Pointer Spatula	6	10	100.00
LASC8888165	165 mm Scoop	6.5	10	90.00
LASL8888510	Big Spoon Spatula	10	10	255.00

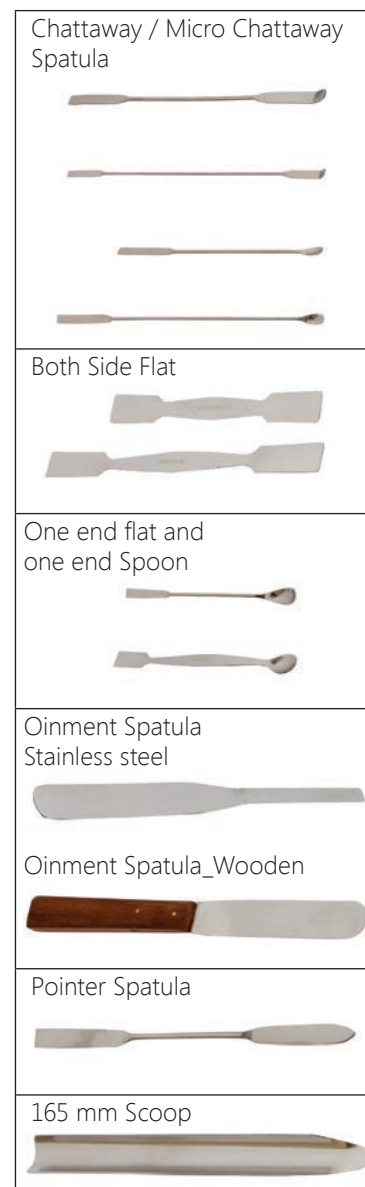

* For products listed on the above table use HSN code 90189022



FORCEPS POINTED

Product Code	Description	Case Lot No.	Price / Piece ₹
LAFP8888004	Forceps, Pointed dissecting, 4"	10	105.00
LAFP8888005	Forceps, Pointed dissecting, 5"	10	140.00
LAFP8888006	Forceps, Pointed dissecting, 6"	10	170.00



FORCEPS PTFE POINTED

Product Code	Description	Case Lot No.	Price / Piece ₹
LAFPP8888004	Forceps, PTFE, Pointed end, 4"	10	1470.00
LAFPP8888006	Forceps, PTFE, Pointed end, 6"	10	1890.00



FORCEPS BLUNT DISSECTING

Product Code	Description	Case Lot No.	Price / Piece ₹
LAFB8888005	Forceps, Blunt dissecting, 5"	10	150.00
LAFB8888006	Forceps, Blunt dissecting, 6"	10	160.00
LAFB8888008	Forceps, Blunt dissecting, 8"	10	220.00



FORCEPS PTFE BLUNT

Product Code	Description	Case Lot No.	Price / Piece ₹
LAFBP8888004	Forceps, PTFE, Blunt end, 4"	10	1470.00
LAFBP8888006	Forceps, PTFE, Blunt end, 6"	10	1890.00



WIRE GAUGE

Product Code	Description	Case Lot No.	Price / Piece ₹
LAWG8888C06	Wire Gauge with Ceramic center 5" x 5"	10	125.00
LAWG8888C05	Wire Gauge with Ceramic center 6" x 6"	10	100.00



TRIANGULAR TRIPOD

Product Code	Description	Case Lot No.	Price / Piece ₹
LATT8888200	Triangular Tripod, SS, 200 x 125 mm	2	590.00

BOROSIL®

Laboratory Accessories

Tongs

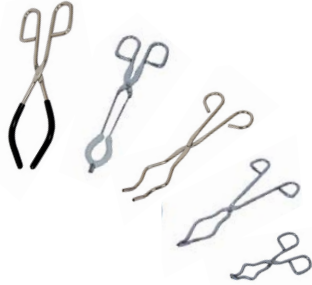

Clamp with PVC Coated Prong



Clamp



Clamp with Bosshead



Burette Clamp



Boss Head



Retort Ring & Test Tube Holder



Retort Base



Rod For Retort Base



Z Shape Test Tube Stand



Burner



Spatula



BOROSIL[®]

Quartz Ware

Boron Free Transparent Silica

Borosil Fused Silica 99.95% SiO₂ surpasses all of the desirable chemical and weathering durability properties usually associated with opaque Silica ware. We manufacture as per IS and BS Standards.



a) There is little or no visible surface change or damage to silica with prolonged exposure to water, atmospheric gases, contaminants, oxide of nitrogen and ozone.

b) Attack does occur, on exposure to alkaline solution and acids at very high temperatures.

c) Low expansion and hence excellent dimensional stability and thermal shock resistance.



Resistant to chemical attack

Virtually unaffected by sulphuric, nitric and hydrochloric acids. Hot alkalis and certain metal oxides react on silica. It is attacked by hydrofluoric acid. At high temperatures, it is also attacked by phosphoric acid.

Continuous use of fused silica above 1000°C leads to devitrification with formation of cristobalite which is a crystalline phase and will lead to breakage on repeated use. For accurate and long use, it is advisable to wash the articles in distilled water and alcohol to remove trace impurities.

Heating fused quartz to elevated temperatures causes SiO₂ to undergo dissociation. Consequently, when flame-working fused quartz, there is a band of haze or smoke which forms just outside the intensely heated region. This haze presumably forms because the SiO₂ recombines with oxygen from the air (and perhaps water) and condenses as extremely small particles of amorphous SiO₂.

Co-efficient of expansion 0°C to 800°C

5.5 X 10⁻⁷ cm / cm / °C

Softening Point

1685°C

Annealing Point

1200°C

Strain Point

1120°C

Operating Temp

1050°C

Electrical resistivity (at 350°C)

7 x 10⁷ ohm cm

1002 - QUARTZ LOW FORM BEAKER

With Spout

- Beaker with Spout for Clean Pouring
- Dimensional accuracy
- Tough construction
- Durability

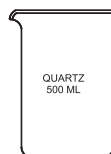

Product Code	Capacity ml	Approx O.D. x Length mm	Quantity Per Case	Price / Piece ₹
1002009	25	35 x 45	5	1280.00
1002012	50	40 x 58	5	1890.00
1002016	100	50 x 75	5	2905.00
1002018	150	55 x 88	5	3760.00
1002021	250	70 x 95	1	5620.00
1002024	500	85 x 115	1	10760.00
1002029	1000	105 x 145	1	18720.00

3175 - QUARTZ MUFFLE TRAYS

- Perfect finish
- Sturdiness
- Durability
- Holes: 2/4

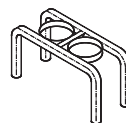

Product Code	Capacity ml	Approx O.D. x Length mm	Quantity Per Case	Price / Piece ₹
3175041	2 Holes	39	1	1690.00
3175042	4 Holes	76	1	3300.00

3185 - QUARTZ ROUND DISHES/BASINS

With Spout

- Round with Spout
- Perfect finish
- Accurate dimensions
- Longer life span



Product Code	Approx O.D. x Height mm	Nominal Capacity ml	Quantity Per Case	Price / Piece ₹
3185008	55 x 23	20	10	1110.00
3185042	75 x 27	45	5	3135.00
3185044	85 x 35	70	5	3915.00
3185045	95 x 36	85	1	6480.00
3185016	100 x 38	100	1	7800.00
3185046	115 x 47	200	1	11860.00

Quartz Ware &
Sintered Ware

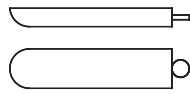

3186 - QUARTZ COMBUSTION BOATS

With Handle

- Light in weight
- Longer life span
- Accurate dimensions
- Sturdiness

Product Code	Approx O.D. x Length mm	Quantity Per Case	Price / Piece ₹
3186Q01	12 x 77	1	1040.00

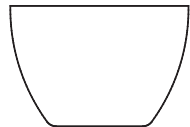

3190 - QUARTZ CRUCIBLES

Without Lid

- Accurate dimensions
- Longer life span
- Fine finish
- Sturdiness

Product Code	Capacity ml	Approx O.D. x Length mm	Quantity Per Case	Price / Piece ₹
3190007	15	40 x 26	10	610.00
3190009	25	47 x 30	10	885.00
3190012	50	57 x 35	10	1415.00
3190015	80	69 x 45	10	2280.00
3190018	150	80 x 54	5	4180.00

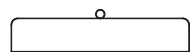

3191 - LIDS FOR QUARTZ CRUCIBLES (CAT. NO. 3190)

- Accurate dimension
- Longer life span
- Fine finish
- Sturdiness

Product Code	Capacity ml	Quantity Per Case	Price / Piece ₹
3191007	15	10	600.00
3191009	25	10	850.00
3191012	50	10	1330.00
3191015	80	10	2205.00

3195, 3196 & 3197 - QUARTZ VOLATILE MATTER CRUCIBLES

- Dimensional accuracy
- Tough construction
- Durability
- Comes with Lid and Plunger

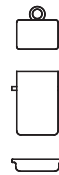

Product Code	Catalogue No.	Item	Dimension mm	Quantity Per Case	Price / Piece ₹
3195041	3195	Crucible	25 x 38	5	1710.00
3196041	3196	Plunger	12.5	5	560.00
3197041	3197	Lid		5	500.00

3198 - QUARTZ SILICA TRIANGLES on Nichrome (Translucent)

- Longer life span
- Sturdiness
- Seamless finish

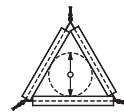

Product Code	Capacity ml	Quantity Per Case	Price / Piece ₹
3198007	15	10	220.00
3198009	25	10	295.00
3198012	50	10	560.00
3198015	80	5	800.00

4984 - QUARTZ ERLLENMEYER (CONICAL) FLASK

- Suitable for digestion of samples with concentrated acid (except HF)
- Ideal for estimation of boron in soil
- Withstand sudden heating & cooling

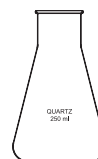

Product Code	Capacity ml	External Dimension		Price / Piece ₹
		O.D. mm	Height mm	
4984016	100	64	105	5880.00
4984018	150	72	124	7235.00
4984021	250	85	140	9155.00



Quartz Ware & Sintered Ware

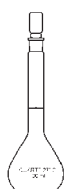

5644 - QUARTZ VOLUMETRIC FLASK

With I/C Quartz Stopper, Class B

- Dimensional accuracy
- Sturdiness
- Durability
- Perfect finish

Product Code	Capacity ml	Quantity Per Case	Price / Piece ₹
5644005	5	1	4930.00
5644006	10	1	2830.00
5644009	25	1	3350.00
5644012	50	1	4010.00
5644016	100	1	5180.00
5644021	250	1	7510.00
5644024	500	1	10000.00
5644029	1000	1	19980.00



8600 - QUARTZ CIRCULAR CAPSULE

- Suitable for determination of ash content in coal analysis
- Withstand sudden heating & cooling

Product Code	External Dimension		Price / Piece ₹
	Height mm	Diameter mm	
8600Q01	14	48	1415.00
8600Q02	15	54	1610.00

*The ash content in coal is an important parameter in determining the quality of coal. Ash reduces the calorific value of coals and hence burning coals on a large scale require knowledge of their ash content. Analysis is fairly straight forward, with the coal thoroughly burnt at 750°C to 800°C and the ash material express as a percentage of the original weight. It gives an indication about the quality of coal.

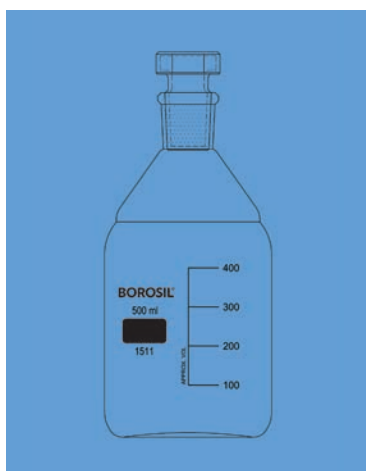

1511 - QUARTZ REAGENT BOTTLE

With Hollow Quartz I/C Stopper

Product Code	Capacity ml	Quantity Per Case	Price / Piece ₹
1511024	500	1	16275.00

3028 - QUARTZ MEASURING CYLINDER

With Spout, Class B

Product Code	Capacity ml	Quantity Per Case	Price / Piece ₹
3028005	5	1	6560.00
3028006	10	1	7350.00
3028009	25	1	9975.00
3028012	50	1	15225.00
3028016	100	1	20475.00
3028021	250	1	29400.00
3028024	500	1	40425.00

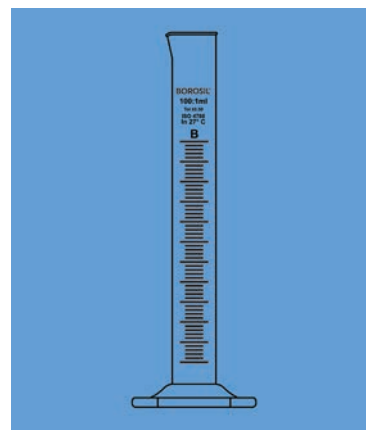

6141 - QUARTZ FILTER FUNNEL, 60°

Product Code	Capacity ml	Quantity Per Case	Price / Piece ₹
6141071	75	1	15355.00

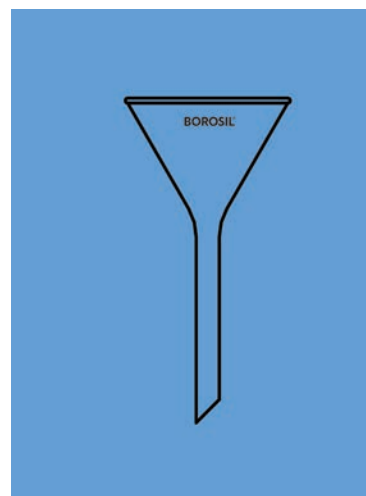

7064 - QUARTZ MOHR GRADUATED PIPETTES, CLASS B

Product Code	Capacity ml	Quantity Per Case	Price / Piece ₹
7064P41	1 x 0.01	1	8505.00
7064P22	2 x 0.1	1	5775.00
7064P55	5 x 0.1	1	7455.00
7064P06	10 x 0.1	1	8925.00

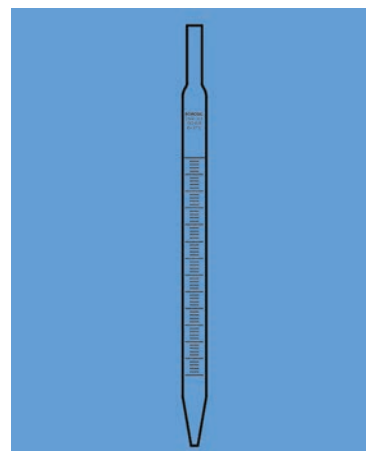

7104 - QUARTZ VOLUMETRIC PIPETTES, CLASS B

Product Code	Capacity ml	Quantity Per Case	Price / Piece ₹
7104001	1	1	6520.00
7104002	2	1	6520.00
7104003	3	1	8450.00
7104004	4	1	8450.00
7104005	5	1	8315.00
7104706	6	1	9355.00
7104006	10	1	11435.00

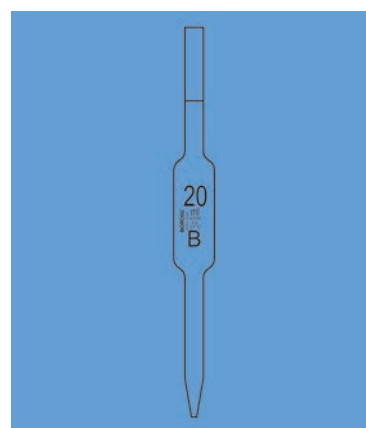

Quartz Ware &
Sintered Ware

Sintered Ware

Technical Data

Borosil Sintered Glassware is used for filtration of liquids and gases in the laboratory. It has a non-corrosive and reusable porous glass disc as the filter media. It is also used for gas washing, dispersion and absorption.

The Sintered Disc is manufactured by crushing Borosil glass, and then powdering, cleaning and separating it into various mesh sizes, and finally, fusing it together in the form of a Disc. Sintered Discs are classified into 5 grades - G1, G2, G3, G4 and G5. The grades are defined in terms of the maximum pore size that is obtained by measuring the pressure at which the first air bubble breaks away from the filter, under specified conditions. The pressure differential is then used to calculate the equivalent capillary diameters in microns. The desired pore size is obtained by controlling the grain size, firing time, temperature and thickness of the Disc. Each Disc is tested and graded individually.

The pore diameters are reasonably uniform, which ensures the required flow rate through the filter. The flow rate further depends on the pressure differential between the two sides of the Disc, the free area of the Disc, viscosity of the fluid being filtered, and other factors. There is a fair amount of uniformity in the pore size of different Discs of the same size and grade. Hence, the results from two or more Discs of the same size and grade will be uniform, thereby ensuring reproducible analytical results.

The Discs have maximum surface hardness and hence, the glass powder does not get scraped off while cleaning or with chemicals. The filters do not shed particles during usage.

The Discs are sealed to tubing without blocking the pores. They are then annealed properly in automatically controlled Lehrs.

Porosity Grades And Their General Use

Porosity Grade	Pore Size (Microns)	General use
1	90-150	Filtration of coarse materials / precipitates, gas dispersion, gas washing, extractor bed, support for other filter materials.
2	40-90	Filtration of medium precipitates gas dispersion, gas washing.
3	15-40	Filtration of fine grain precipitates. Analytical work with medium precipitates. Mercury filtration
4	5-15	Analytical work with fine and very fine precipitates. Non return mercury valves.
5	1-2	Bacteriological filtration.

Chemical Durability

Borosil Sintered Ware is manufactured with the same high quality material of which all Borosil brand borosilicate laboratory glassware is made, ensuring excellent resistance to chemical attack.

Operating Pressure

Sintered Discs, and the glassware that incorporates them, are designed mainly for the application of vacuum or for passage of gases at relatively low pressure. In all cases, the differential pressure must not exceed 100 KN / m² (15 psi).

Thermal Limitations

Sintered Ware has a lower level of resistance to thermal shock as compared to standard Borosil glassware. Therefore, articles of Sintered Ware should not be subjected to excessive temperature changes or direct flames.

Borosil Sintered Crucibles are especially suitable for drying to constant weight. Dry Sintered Crucibles at room temperature, can be placed directly into a drying oven. Sintered Ware may safely be heated in a furnace to 500°C without any adverse effects, while ensuring that the cycle of heating and cooling is gradual. It is recommended that the rate of heating does not exceed 20°C/min. This prevents internal strains caused by excessive temperature differences between the surrounding glass vessel and the Sintered Disc that, in turn, can lead to fracture of the apparatus.

When cold and damp, Sintered Ware of porosity grades 4 and 5 should never be subjected to a sudden temperature change as the evolution of steam may generate pressure within the filter, sufficient to crack it.

Filtration Apparatus should be kept on its rim (stem upwards) in an oven or steriliser. A perforated support base is advantageous for air convection in case of pipeline filters. By using heat insulating material such as asbestos, care should be taken to avoid premature heating near the filter seal. The apparatus should remain in the oven or steriliser during cooling, to prevent excessively fast cooling.

Cleaning Of Sintered Ware

New Sintered Filters should be washed carefully with hot hydrochloric acid, and then rinsed with distilled water before use. Such treatment ensures that all loose particles are removed from the Filter.

It is advisable to clean all Sintered Filters thoroughly, immediately after use, as cleaning is easiest at this time, and it also reduces the risk of contamination in the next use.

Many precipitates can be removed from the filter by back-flushing with water. However, great care must be taken with large diameters and fine filters, as positive pressures on the reverse side may break the filter.

Under no circumstances should Sintered Apparatus be subjected to mains water pressure when back-flushing, as in most instances this leads to fractured filters.

Drawing water through the filter from the reverse side, by means of a vacuum pump, is also effective.

Filters clogged with dust and dirt during gas filtration can be restored by treatment with warm detergent solution, followed by blowing clean air through, from the clean side of the filter. Dirt particles are brought to the surface by the foam, and removed by rinsing with water.

Some precipitates that clog the filter may be removed by chemical cleaning, as indicated below:

- **Fats and grease**
Carbon tetrachloride or suitable organic solvent
- **Albumen glucose:**
Hot ammonia or hydrochloric acid, mixture of hot concentrated sulphuric and nitric acids
- **Organic substances :**
'Chromic' acid cleaning solution* or concentrated sulphuric acid containing a little potassium nitrate or perchlorate (0.5%) (may need to be soaked overnight)
- **Copper or iron oxide :**
Hot concentrated hydrochloric acid with potassium chlorate.
- **Barium sulphate :**
Hot concentrated sulphuric acid
- **Mercury Residues :**
Hot concentrate nitric acid
- **Mercury Sulphide :**
Hot aqua regia
- **Silver chloride :**
Ammonia or sodium hyposulphite
- **Stannic oxide :**
Boiling sulphuric acid**

Alumina or silica residues :

2% hydrofluoric acid followed by concentrated sulphuric acid. Rinse immediately with distilled water and then with acetone. Continue rinsing until no trace of acid remains.

High concentrations of hydrofluoric acid, hot phosphoric acid or caustic alkali solutions should never be used for cleaning. Using these causes a rapid deterioration in the filter and an increase in pore size.

* For bacteriological, pharmaceutical and biological work, 'chromic' acid cleaning solution should be avoided in view of the biological effect of chromium ions.

** Boiling sulphuric acid may introduce undue thermal strain. It is therefore advisable to leave the item in the acid to cool.



36060 - BUCHNER FUNNEL

With Sintered Disc

- Made of 3.3 borosilicate glass
- Especially useful where the filter paper may be attacked by filtered material
- Generally used in qualitative inorganic analysis and preparative chemistry
- Resistant to corrosion and heat

Product Code	Capacity ml	Porosity Grade	Dia of Disc mm	Approx Height mm	Stem Dia mm	Quantity Per Case	Price / Piece ₹
3606058	35	1	30	130	8	5	535.00
3606658	35	2	30	130	8	5	535.00
3606758	35	3	30	130	8	5	535.00
3606858	35	4	30	130	8	5	535.00
3606958	35	5	30	130	8	5	640.00
3606072	80	1	35	142	8	5	1040.00
3606672	80	2	35	142	8	5	1040.00
3606772	80	3	35	142	8	5	1040.00
3606872	80	4	35	142	8	5	1040.00
3606972	80	5	35	142	8	5	1260.00
3606020	200	1	68	215	13	5	1620.00
3606620	200	2	68	215	13	5	1620.00
3606720	200	3	68	215	13	5	1620.00
3606820	200	4	68	215	13	5	1620.00
3606920	200	5	68	215	13	5	1880.00
3606024	500	1	92	258	17	2	3810.00
3606624	500	2	92	258	17	2	3810.00
3606724	500	3	92	258	17	2	3810.00
3606824	500	4	92	258	17	2	3810.00
3606924	500	5	92	258	17	2	4985.00
3606029	1000	1	124	276	19	2	7370.00
3606629	1000	2	124	276	19	2	7370.00
3606729	1000	3	124	276	19	2	7370.00
3606829	1000	4	124	276	19	2	7370.00
3606929	1000	5	124	276	19	2	9420.00

32060 - GOOCH CRUCIBLE

Low Form, With Sintered Disc

- Made of 3.3 borosilicate glass
- Particularly adapted to analytical work where precipitates are dried to constant weight at 110°C
- Crucibles should not be subjected to sudden temperature changes
- In order to avoid strain, they should not be removed from the furnace until the temperature has dropped to 250°C
- Gooch Crucible is used for metal casting and analysis

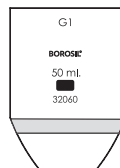

Product Code	Capacity ml	Porosity Grade mm	Dia of Disc mm	Approx Height	Quantity Per Case	Price / Piece ₹
3206007	15	1	20	50	10	385.00
3206607	15	2	20	50	10	385.00
3206707	15	3	20	50	10	385.00
3206807	15	4	20	50	10	385.00
3206907	15	5	20	50	10	475.00
3206010	30	1	30	60	10	515.00
3206610	30	2	30	60	10	515.00
3206710	30	3	30	60	10	515.00
3206810	30	4	30	60	10	515.00
3206910	30	5	30	60	10	630.00
3206012	50	1	40	65	10	590.00
3206612	50	2	40	65	10	590.00
3206712	50	3	40	65	10	590.00
3206812	50	4	40	65	10	590.00
3206912	50	5	40	65	10	740.00

32061 - TUBE FOR GOOCH CRUCIBLE

- Made of 3.3 borosilicate glass
- Suitable for use with Borosil's Gooch Crucible with sintered disc



Product Code	Approx O.D. x Length mm	Quantity Per Case	Price / Piece ₹
3206127	27 x 150	5	170.00
3206136	36 x 160	5	240.00
3206156	56 x 170	10	360.00

These are suitable for use with our filtering crucibles Gooch Type with sintered disc, No. 32060 lower part 8 mm O.D. x 75 mm length in all sizes.



Quartz Ware & Sintered Ware

BOROSIL®

Analytical Vials & Closures

“for Labs where
compliance matters”

- 2ml HPLC SAMPLE
VIALS / CLOSURES / KIT
- 20ml HEADSPACE
VIALS / CAP / CLOSURES / KIT
- PRE-ASSEMBLED
EPA / TOC VIALS / CAPS / KIT

Why should I choose BOROSIL vials?

No matter which make of instrument you use, it is critical that your sample is carried in a reliable vial.

Whereas, it is important that vials are made within stringent dimensions in controlled conditions to perform consistently, it is even more critical to a Chemist to be able to confidently rule out the vial as a contributor to an OOS (out of specification) incident.

BOROSIL being a manufacturer of vials, provides a Chemist access to the detailed testing & quality documentation of vials thereby enabling a chemist to investigate root causes effectively.



Borosil certified Vials are manufactured in an ISO 9001 certified facility, in accordance with US and European Pharmacopoeia.

Easy ordering!!!

The 14 Digit Code

Whether you choose to buy a combipack that includes **Vials** and matching **Closures** or only the glass vial or only the vial closure, **BOROSIL's 14 digit code** makes it very easy in **FOUR** simple steps!

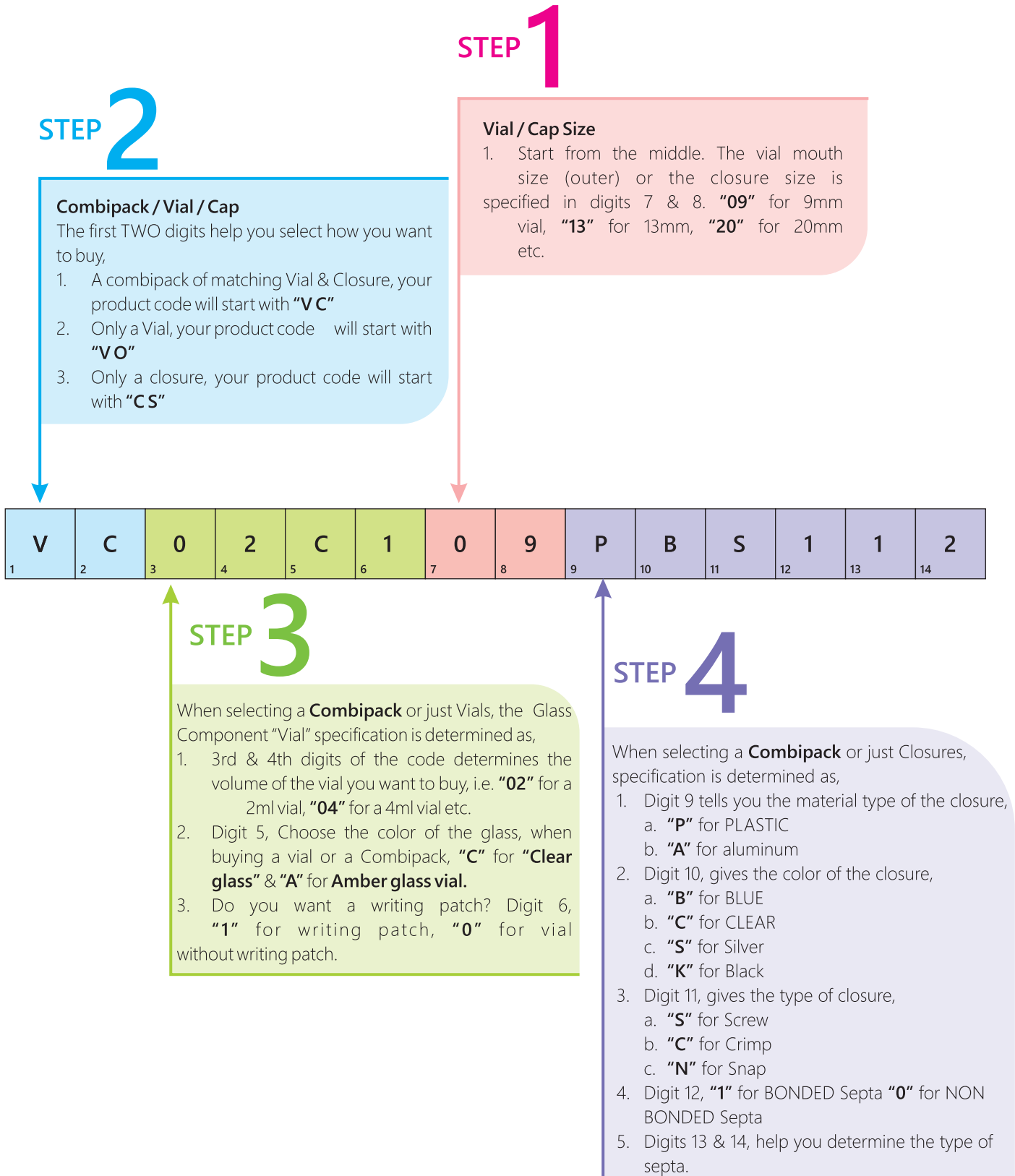

SAMPLE VIALS & CLOSURES

2ml HPLC SAMPLE VIALS



Screw Neck Vial/Cap

Crimp Neck Vial/Cap



Ordering Information - 2ml Glass Vials ONLY

Product Code	TYPE	Neck Size	Color	Marking	Glass Specs	Pack Size	Case Lot	Price / Case ₹
VO02C00900S000	Screw	9mm	Clear	–	USP TYPE I 5.1 Ex	100/pk	100/pk x 10	11,000.00
VO02C10900S000	Screw	9mm	Clear	Write On	USP TYPE I 5.1 Ex	100/pk	100/pk x 10	13,000.00
VO02A00900S000	Screw	9mm	Amber	–	USP TYPE I 5.4 Ex	100/pk	100/pk x 10	14,500.00
VO02A10900S000	Screw	9mm	Amber	Write On	USP TYPE I 5.4 Ex	100/pk	100/pk x 10	17,700.00
VO02C01100C000	Crimp	11mm	Clear	–	USP TYPE I 5.1 Ex	100/pk	100/pk x 10	9,600.00
VO02C11100C000	Crimp	11mm	Clear	Write On	USP TYPE I 5.1 Ex	100/pk	100/pk x 10	10,400.00
VO02A01100C000	Crimp	11mm	Amber	–	USP TYPE I 5.4 Ex	100/pk	100/pk x 10	11,300.00
VO02A11100C000	Crimp	11mm	Amber	Write On	USP TYPE I 5.4 Ex	100/pk	100/pk x 10	13,900.00

Ordering Information - 2ml Closures ONLY

Product Code	Type	Cap Size	Septum	Closure Feature	Pack Size	Case Lot	Price / Case ₹
CS000009PBS111	Screw	9mm	Silicone- PTFE	–	100/pk	100/pk x 10	18,000.00
CS000009PBS124	Screw	9mm	Silicone- PTFE	Pre-Slit	100/pk	100/pk x 10	14,160.00
CS000009PBS114	Screw	9mm	Silicone- PTFE	Pre-Slit	100/pk	100/pk x 10	14,160.00
CS000009PBS113	Screw	9mm	Silicone- PTFE	Pre-Slit	100/pk	100/pk x 10	21,240.00
CS000011ASC021	Crimp	11mm	Silicone- PTFE	–	100/pk	100/pk x 10	10,740.00
CS000011ASC022	Crimp	11mm	Silicone- PTFE	Pre-Slit	100/pk	100/pk x 10	12,750.00

Ordering Information - 2ml Vial with Closures in a ready to use kit

Product Code	Product Line	Type	Neck Size	Vial Color	Marking	Glass Specs	Septum	Closure Feature	Pack Size	Case Lot	Price / Case ₹
VC02C009PBS111	Everyday	Screw	9mm	Clear	–	USP TYPE I 5.1 Ex	Silicone - PTFE	–	100/pk	100/pk x 10	29,000.00
VC02C009PBS114	Everyday	Screw	9mm	Clear	–	USP TYPE I 5.1 Ex	Silicone - PTFE	Pre-Slit	100/pk	100/pk x 10	23,000.00
VC02C009PBS124	Everyday	Screw	9mm	Clear	–	USP TYPE I 5.1 Ex	Silicone - PTFE	–	100/pk	100/pk x 10	23,000.00
VC02C009PBS113	Certified	Screw	9mm	Clear	–	USP TYPE I 5.1 Ex	Silicone - PTFE	Pre-Slit	100/pk	100/pk x 10	29,000.00
VC02C109PBS111	Everyday	Screw	9mm	Clear	Write On	USP TYPE I 5.1 Ex	Silicone - PTFE	–	100/pk	100/pk x 10	31,100.00
VC02C109PBS114	Everyday	Screw	9mm	Clear	Write On	USP TYPE I 5.1 Ex	Silicone - PTFE	Pre-Slit	100/pk	100/pk x 10	25,100.00
VC02C109PBS124	Everyday	Screw	9mm	Clear	Write On	USP TYPE I 5.1 Ex	Silicone - PTFE	–	100/pk	100/pk x 10	25,100.00
VC02C109PBS113	Certified	Screw	9mm	Clear	Write On	USP TYPE I 5.1 Ex	Silicone - PTFE	Pre-Slit	100/pk	100/pk x 10	31,100.00
VC02C109PBSUM1	MS Certified	Screw	9mm	Clear	Write On	USP TYPE I 5.1 Ex	Silicone - PTFE	MS Cert	100/pk	100/pk x 10	38,100.00
VC02C109PBSUM2	MS Certified	Screw	9mm	Clear	Write On	USP TYPE I 5.1 Ex	Silicone - PTFE	Pre-Slit- MS Cert	100/pk	100/pk x 10	38,100.00
VC02C409PBS111	Everyday	Screw	9mm	Clear	Write On	USP TYPE I 3.3 Ex	Silicone - PTFE	–	100/pk	100/pk x 10	40,000.00
VC02C409PBS113	Certified	Screw	9mm	Clear	Write On	USP TYPE I 3.3 Ex	Silicone - PTFE	MS Cert	100/pk	100/pk x 10	40,000.00
VC02C409PBSUM1	MS Certified	Screw	9mm	Clear	Write On	USP TYPE I 3.3 Ex	Silicone - PTFE	Pre-Slit- MS Cert	100/pk	100/pk x 10	47,000.00
VC02C409PBSUM2	MS Certified	Screw	9mm	Clear	Write On	USP TYPE I 3.3 Ex	Silicone - PTFE	–	100/pk	100/pk x 10	47,000.00
VC02A009PBS111	Everyday	Screw	9mm	Amber	–	USP TYPE I 5.4 Ex	Silicone - PTFE	–	100/pk	100/pk x 10	32,500.00
VC02A009PBS114	Everyday	Screw	9mm	Amber	–	USP TYPE I 5.4 Ex	Silicone - PTFE	Pre-Slit	100/pk	100/pk x 10	26,500.00
VC02A009PBS124	Everyday	Screw	9mm	Amber	–	USP TYPE I 5.4 Ex	Silicone - PTFE	–	100/pk	100/pk x 10	26,500.00
VC02A009PBS113	Certified	Screw	9mm	Amber	–	USP TYPE I 5.4 Ex	Silicone - PTFE	Pre-Slit	100/pk	100/pk x 10	32,500.00
VC02A109PBS111	Everyday	Screw	9mm	Amber	Write On	USP TYPE I 5.4 Ex	Silicone - PTFE	–	100/pk	100/pk x 10	35,700.00
VC02A109PBS114	Everyday	Screw	9mm	Amber	Write On	USP TYPE I 5.4 Ex	Silicone - PTFE	Pre-Slit	100/pk	100/pk x 10	29,700.00
VC02A109PBS124	Everyday	Screw	9mm	Amber	Write On	USP TYPE I 5.4 Ex	Silicone - PTFE	–	100/pk	100/pk x 10	29,700.00
VC02A109PBS113	Certified	Screw	9mm	Amber	Write On	USP TYPE I 5.4 Ex	Silicone - PTFE	Pre-Slit	100/pk	100/pk x 10	35,700.00
VC02A109PBSUM1	MS Certified	Screw	9mm	Amber	Write On	USP TYPE I 5.4 Ex	Silicone - PTFE	MS Cert	100/pk	100/pk x 10	47,000.00
VC02A109PBSUM2	MS Certified	Screw	9mm	Amber	Write On	USP TYPE I 5.4 Ex	Silicone - PTFE	Pre-Slit- MS Cert	100/pk	100/pk x 10	47,000.00
VC02C011ASC021	Everyday	Crimp	11mm	Clear	–	USP TYPE I 5.1 Ex	Silicone - PTFE	–	100/pk	100/pk x 10	18,700.00
VC02C011ASC022	Everyday	Crimp	11mm	Clear	–	USP TYPE I 5.1 Ex	Silicone - PTFE	Pre-Slit	100/pk	100/pk x 10	20,400.00
VC02C111ASC021	Everyday	Crimp	11mm	Clear	Write On	USP TYPE I 5.1 Ex	Silicone - PTFE	–	100/pk	100/pk x 10	19,500.00
VC02C111ASC022	Everyday	Crimp	11mm	Clear	Write On	USP TYPE I 5.1 Ex	Silicone - PTFE	Pre-Slit	100/pk	100/pk x 10	21,200.00
VC02A011ASC021	Everyday	Crimp	11mm	Amber	–	USP TYPE I 5.4 Ex	Silicone - PTFE	–	100/pk	100/pk x 10	19,480.00
VC02A011ASC022	Everyday	Crimp	11mm	Amber	–	USP TYPE I 5.4 Ex	Silicone - PTFE	Pre-Slit	100/pk	100/pk x 10	21,040.00
VC02A111ASC021	Everyday	Crimp	11mm	Amber	Write On	USP TYPE I 5.4 Ex	Silicone - PTFE	–	100/pk	100/pk x 10	21,930.00
VC02A111ASC022	Everyday	Crimp	11mm	Amber	Write On	USP TYPE I 5.4 Ex	Silicone - PTFE	Pre-Slit	100/pk	100/pk x 10	23,490.00



Headspace Vials & Closures

Colour	Cap MOC	Top	Septa Mount	Septa MOC	Feature
Silver	Aluminum	Open	Open	Silicone PTFE	Ultra Clean



Headspace - 20ml Vial and Cap ready to use kits

Product Code	Glass	Type	Neck Size	Glass Specs	Vial Feature	Closure MOC	Septum	Pack Size	Case Lot	Price / Case ₹
VC20F120ASC041	Clear	Crimp	20mm	USP TYPE I 5.1 Ex	Flat Bottom	Aluminum	Silicone- PTFE	100/pk	5 x 100	32,350.00
VC20F120MSC041	Clear	Crimp	20mm	USP TYPE I 5.1 Ex	Flat Bottom	Magnetic	Silicone- PTFE	100/pk	5 x 100	34,250.00
VC20R120ASC041	Clear	Crimp	20mm	USP TYPE I 5.1 Ex	Round Bottom	Aluminum	Silicone- PTFE	100/pk	5 x 100	32,350.00
VC20R120MSC041	Clear	Crimp	20mm	USP TYPE I 5.1 Ex	Round Bottom	Magnetic	Silicone- PTFE	100/pk	5 x 100	34,250.00

Headspace - 20ml Vial ONLY

Product Code	Glass	Type	Neck Size	Glass Specs	Vial Feature	Pack Size	Case Lot	Price / Case ₹
VO20F12000C000	Clear	Crimp	20mm	USP TYPE I 5.1 Ex	Flat Bottom	100/pk	5 x 100	14,900.00
VO20R12000C000	Clear	Crimp	20mm	USP TYPE I 5.1 Ex	Round Bottom	100/pk	5 x 100	14,900.00

Headspace - Closures

Product Code	Type	Cap Size	Septum	Closure MOC	Pack Size	Case Lot	Price / Case ₹
CS000020ASC041	Crimp	20mm	Silicone PTFE	Aluminum	100/pk	5 x 100	17,450.00
CS000020MSC041	Crimp	20mm	Silicone PTFE	Magnetic	100/pk	5 x 100	19,350.00

Pre-Assembled EPA/TOC Vial & Cap Kits

Product Code	Vol	Glass	Type	Neck Size	Glass Specs	Closure Feature	Septum	Pack Size	Price / Case ₹
VC40C124PWS111	40ml	Clear	Screw	24mm	USP TYPE I 5.1 Ex	Open top	Silicone PTFE	72/pk	10,550.00
VC40A124PWS111	40ml	Amber	Screw	24mm	USP TYPE I 5.4 Ex	Open top	Silicone PTFE	72/pk	11,000.00
VC40C124POS111	40ml	Clear	Screw	24mm	USP TYPE I 5.1 Ex	Protective top cover	Silicone PTFE	72/pk	13,050.00
VC40A124POS111	40ml	Amber	Screw	24mm	USP TYPE I 5.4 Ex	Protective top cover	Silicone PTFE	72/pk	13,500.00

BOROSIL®

Quality Assurance



Raw Material

100% traceability across all manufacturing processes to raw materials. Batch BMR comprehensive confirms compliance to all critical specifications.

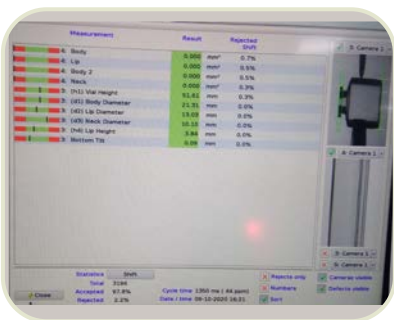

Dimensional Conformity

A vial's dimensions are extremely important to achieve reliable auto sampler functioning and proper vial cap fitment. Borosil vials are inspected with inline optical inspection systems to minimize both dimensional and cosmetic defects

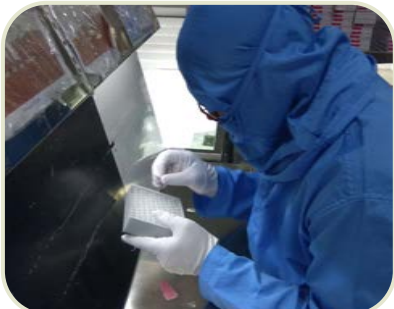

SQC as per ISO 2589-1

In addition to in line inspection, sampling and inspection is also done by SQC for independent verification of process conformity.

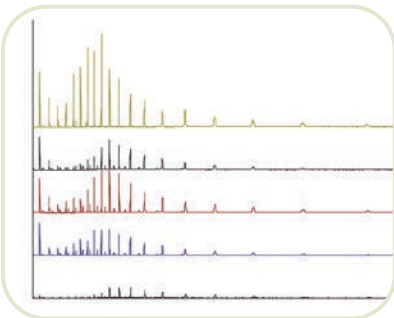

Process Cleanliness Assurance

Vials are packed in a Class 8 clean room. Process cleanliness is also assured by tests to confirm vials to be free from residual organic and qualitative testing for non interference by LCMS & GCMS.



360° Quality System

Conversion process free of human interaction,
Inline inspection, printing and annealing
Dimensional & Cosmetic inspection,

Laboratory Equipment

LabQuest by Borosil are products that meet Borosil's high standards of reliability, performance and value.

All products are backed by Borosil's robust service and after sale support.

Manufacturers of Laboratory Equipment

SMART

RUGGED

PRACTICAL



- KJELDHAL SYSTEM
- COD DIGESTERS
- FAT DETERMINATION APPARATUS
- WATER DISTILLATION UNITS
- CONTROLLED HEATING MANTLES
- STIRRERS
- DRY BATH
- LABWARE DRYER
- VORTEX MIXERS
- CENTRIFUGE
- SHAKERS
- CHILLER
- VACCUM PUMP
- TUBE DISC ROTATORS
- TUBE ROLLERS
- MICROPIPETTES
- BOTTLE TOP DISPENSERS
- DIGITAL BURETTE



KJELDAHL DIGESTION UNIT WITH AUTO-LIFT

Kjeldahl Digestion Systems for highly reproducible results for nitrogen estimation by Kjeldahl method

- Fast, safe and complete digestion of samples through aluminium blocks.
- Intricately control digestion temperature curves for unsupervised digestion
- Monitor process parameters & pre-set sample cycles
- Autolift enables complete automation and safety
- Cooling stations increase throughput by decreasing the cooling time post digestion



Model Name	KBD083	KBD123	KBD203
Type	Block Digester	Block Digester	Block Digester
No. of positions	8	12	20
Tube capacity (ml)		250 / 400	
Temperature Range		Ambient to 470°C	
Timer Range		1-300 mins	
Temperature Precision		±1°C	
Ramp and Hold		upto 4	
Presets		upto 99	
Auto scrubber ON/OFF		Yes	
PID control		Yes	
Autolift		Yes	
Auto OFF after achieving set time		Yes	
Temperature Calibration		Yes, single and two point	
PC & Printer Connectivity		Yes, upgradable	
Display		Graphical LCD	
Body		Stainless steel with control pannel of FRP	
Current Consumption	6A	8A	12A
Dimensions (W x D x H)	(416 X 554 X 595) mm		(410 x 585 x 735) mm
Power Consumption	1400W	1600W	2800W
HSN Code	84790000		
Ordering Code	BLFAKBD08300000000	BLFAKBD12300000000	BLFAKBD20300000000
Prices / Piece	On request		

KJELDAHL DIGESTION UNIT

Kjeldahl Digestion Systems for highly reproducible results for nitrogen estimation by Kjeldahl method

- High grade aluminium block for uniform heating
- Dripping tray that offers protection to digester body
- Easy convenient connection to Fume Scrubber
- Perfect fit of manifolds to the tube for optimum safety



Model Name	KIR020*	KBD061*	KBD062	KBD082	KBD122
Type	Infrared Digester	Block Digester			
No. of positions	2	6	6	8	12
Tube capacity (ml)	250	250	250	250	250
Temperature Range	Ambient to 470°C				
Timer Range	1-300 mins				
Temperature Precision	±1°C				
Ramp and Hold	No	upto 4			
Presets	No	upto 99			
Auto scrubber ON/OFF	No	Yes			
PID control	No	Yes			
Auto OFF after achieving set time	Yes				
Temperature Calibration	No	Yes, single and two point			
PC & Printer Connectivity	No	Yes, upgradable			
Display	LCD	Graphical LCD			
Body	Stainless Steel		Stainless steel with control panel of FRP		
Current Consumption	4A	6A	6A	6A	8A
Dimensions (W x D x H) mm	(330 X 360 X 665)	(414 X 450 X 665)	(414 X 450 X 665)	(416 X 554 X 595)	
Power Consumption	800W	1300W		1400W	1600W
HSN Code	84190000	84198990			
Ordering Code	BLFAKIR0200000000	BLFAKBD0610000000	BLFAKBD0620000000	BLFAKBD0820000000	BLFAKBD1220000000
Prices / Piece	On request				

* Till stock lasts

COOLING STATIONS



THW200

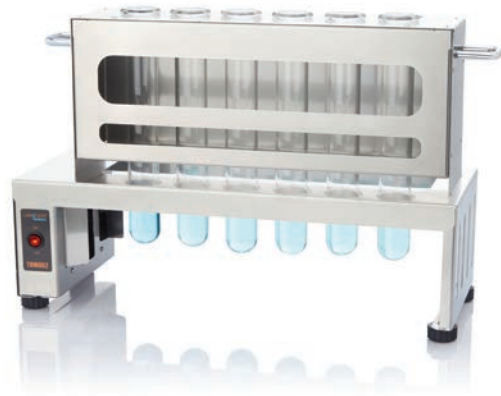

THW062



THW020



THW061

OPTIONAL ACCESSORIES

Description	Product Code
Viton Rubber Tube - 10 mm ID x 14 mm OD	BLA0VRT10D0014DBLK
TEFLON FUME CAP for KBD/ KIR	BLAAFUT100PTFE1651
KBD061 SS TEST TUBE HOLDER RACK ASM	BLMAKBD06120000010
KIR020 TEST TUBE HOLDER ASM	BLAAKIR020230000000
KIR060 TEST TUBE HOLDER ASM	BLAAKIR060200000000
KBD082 TEST TUBE HOLDER ASM	BLAAKBD082200000000
KBD202 TEST TUBE HOLDER ASM	BLAAKBD202200000000
2 position cooling station inline	BLFATHW020000000000
6 position cooling station 2X3	BLFATHW061000000000
6 position cooling station inline	BLFATHW062000000000
8 position cooling station 2 X 4	BLFATHW810000000000
12 position cooling station 6 X 2	BLFATHW121000000000
20 position cooling station 5X4	BLFATHW200000000000
250 ml Borosilicate Test Tube ASM (Set of 5)	BLMATTB01041250000
250 ml Quartz Test Tube ASM (Set of 2)	BLGATTQ01041250000
400 ml Borosilicate Test Tube ASM (Set of 5)	BLAATTB01050400001

FUME SCRUBBER

Safe

- Zero exposure of the user to harmful sulfur dioxide fumes
- Maximum safety with a self-contained design
- High capacity pump for larger capacity digesters

Efficient

- Full control of the scrubber via the digester
- Maximal neutralization efficiency by the vacuum pump
- Easy compatibility with all digesters

KSC010



KSC020



Model Name	KSC010	KSC020
Current Consumption	1A	1A
Pump delivery Rate	28 Ltr/Min	45 Ltr/Min
Dimensions (WxDxH)	(445 x 375 x 460) mm	(365 x 375 x 480) mm
Ordering Code	BLFAKSC01000000000	BLFAKSC02000000000
HSN Code	84141000	
Prices / Piece	On request	

ACCESSORIES

Description	Product Code
KSC010 Condenser V2 ASM	BLMAFUTV2KSCCD2932
KSC010 Carbon Bottle ASM	BLM0BGW25012200211
BL 2L Clear Bottle 34/35 Ground Neck ASM	BLA0BGW10001500030
Viton Rubber Tube - 10 mm ID x 14 mm OD	BLA0VRT10D0014DBLK

KJELDAHL DISTILLATION

Kjeldahl Distillation Systems for highly reproducible results for nitrogen estimation by Kjeldahl method

- Touch screen display with PC connectivity for easy operation and data storage
- Process kill switch to halt the process in case of accidental door opening
- Detachable bottom drip tray for extra protection against acid attack
- Anytime alkali addition during the distillation cycle
- Tube sensor that enables safe operating conditions in event of tube damage
- Reagent refill level sensor to avert reagent dry out.



Feature/ Model	KDI050
Steam addition	Automatic
Distilled water addition	Automatic
Alkali addition	Automatic
Boric acid addition	Automatic
Tube Drain	Automatic
Display	7" colored touch screen
Tube Capacity (ml)	250 / 400ml
Steam power (Adjustable)	10-100%
Minimum distillation time (mins)	5
Reagent level sensor	Yes
Anytime alkali addition	Yes
Tube error detection	Yes
Door close sensor	Yes
Process resume from stop	Yes
One point alkali and distilled water pump	Yes
Two point calibration for acid pump	Yes
Real time monitoring of process parameter	Yes
SELV protection	Yes
Programs	40 preset, 30 user editable
PC Connectivity	Yes
Nitrogen recovery	>99.5%
Nitrogen reproducibility	±1 %
RSD	<1%
LOD	1-200mg with of ≥0.1mg of Nitrogen
Current Consumption	10A
Power consumption	1500 W
Dimension (L X B X H) mm	(480 X 470 X 820) mm
HSN Code	84790000
Ordering Code	BLFAKDI05000000000
Prices / Piece	On request

KJELDAHL DISTILLATION

Kjeldahl Distillation Systems for highly reproducible results for nitrogen estimation

- Single encoder push button for units with LCD display to control all automatic functions
- Tube sensor and door sensor for safe operating conditions
- Feature to add alkali anytime during the distillation cycle
- Reagent refill level sensor to avert reagent dry out
- Drip tray to enhance the unit life



Feature/ Model	KDI010	KDI040
Steam addition	Automatic	
Distilled water addition	Manual	Automatic
Alkali addition	Manual	Automatic
Boric acid addition	Manual	Automatic
Input for 20 sample processing	Yes	NA
Display	LCD	
Tube Capacity (ml)	250 / 400ml	
Steam power (Adjustable)	25% to 100%	
Minimum distillation Time (mins)	5	
Reagent level sensor	NA	Yes
Anytime alkali addition	Yes	
Tube error detection	Yes	
Door close sensor	Yes	
Process resume from stop	Yes	
One point alkali and distilled water pump	NA	Yes
Two point calibration for acid pump	NA	Yes
Real time monitoring of process parameter	Yes	
SELV protection	Yes	
User Editable Programs	NA	50 (10 pre defined editable programs)
Nitrogen recovery	>99.5%	
Nitrogen reproducibility	±1 %	
RSD	<1%	
LOD	1-200mg with of ≥0.1mg of Nitrogen	
Current Consumption	5.5 A	5.5 A
Power consumption	1000 W	1000 W
Dimension (L X B X H)	(380 x 350 x 725) mm	(650 x 350 x 725) mm
HSN Code	84790000	
Ordering Code	BLFAKDI01000000000	BLFAKDI04000000000
Prices / Piece	On request	

ACCESSORIES

Description	Code
KDI Drip Tray ASM	BLAOKDI000DRPOTRAY
Oven Mittes - KDI ASM	BLA0OVM000KDI00000
Polypropylene Aspirator Bottle-34101 ASM	BLA0ASBPP050034101

CLASSICAL KJELDAHL DISTILLATION UNIT

- Available with complete set of heaters, glassware and accessories
- Classic laboratory heaters for reliable and lasting intensive heating
- Compact for serial heating in batches



CKD012



CKD062

Model Name	CKD012	CKD062
No. of positions	1	6
Flask Capacity	250ml round bottom flask equivalent to 500ml Kjeldahl flask	
Element Temperature	450 °C	
Temperature accuracy	±1.0°C	
Temperature regulators	1	6
Ramps/ Flask	4	
Display	LED Display with time, temperature & process status	
Timer	1-999 Minutes	
Power consumption	150W	900W
Electrical regulation	0.65A	3.9A
HSN Code	84198990	
Ordering Code	BLFACKD0120000000	BLFACKD0620000000
Price/ unit	On request	

ACCESSORIES

Product Code	Description	List Price
BLA0BGW200KJDLGHM0	Graham condenser 200 mm jacket ACCS	On request
BLA0KSH24290000CKJ	Classical Kjeldahl splash head ACSS	On request
BLA0DOF075COCKBARB	Kjeldahl Dstn Dosing Funnel 75 ml	On request

COD DIGESTION UNIT

- Aluminium block heating unit with provision to keep 8 or 15 samples at a time in 40 mm diameter reaction vessels.
- Insulated heater block body to withstand acidic attacks
- Temperature overheat sensors
- End of cycle audible buzzer
- Continuous graphical monitoring of time & temperature
- Data Print mode available for documentation.
- Editable presets for user convenience



Model No	COD082	COD152
Reflux Type	Open	
Positions	08 Position	15 Position
Capacity	250 ml X 08 tubes	250 ml X 12 tubes
Heating Block	Aluminium	
Temperature Range	Ambient to 180°C	
Temperature Accuracy	±1°C	
Display	Graphic LCD	
Graphical representation of time and temp	Yes	
Two point factory calibration	Yes	
PID autotune	Yes	
User presets	Yes	
Process Timer	0-999 min	
Temperature Control	Yes with Set value and Present value	
Time Control	Yes with Set value and Present value	
Connectivity to Printer	Yes (upgradeable)	
Connectivity to USB	Yes (upgradeable)	
Power consumptions	1400W	1800 W
Current Consumption	6 A	8 A
Unit External Dimensions (WxDxH)	(414 x 414 x 283) mm	(414 x 427 x 283) mm
HSN Code	84194090	
Ordering Code	BLFACOD08200000000	BLFACOD15200000000
Price/ unit	On request	

ACCESSORIES

Product Code	Description	Pack Size	List Price
BLMACND100CODSAC00	COD air condensors	5	On request
BLMATUB100CODSGT20	COD digestion vessels	5	On request

THERMOREACTOR

- Compact design
- Unique one key operation for convenience of operation.
- Transparent UV protective lid for visual monitoring of process.
- Corrosion resistant housing for longer unit life
- Extended applications in determination of COD, Trace Metals, TOC, Total Phosphate, Total Nitrogen and Total Chromium



Model No	COD120
Reflux Type	Sealing
Positions	12 Position
Capacity	16 mm X 100 mm vials
Heating Block	Aluminium
Temperature Range	Ambient to 180°C
Temperature Accuracy	±1°C
Display	LED
Process Timer	0-999 min / Infinite
Temperature Control	Yes with Set value and Present value
Time Control	Yes with Set value and Present value
Transparent Lid	UV protection
Power consumptions	200 W
Current Consumption	1.5 A
Unit External Dimensions (WxDxH)	(275 X 185 X 150) mm
HSN Code	84198990
Ordering Code	BLFHCOD12000000000
Price/ unit	On request

ACCESSORIES

Product Code	Description	Pack Size	List Price
BLAACTB0101600010*	Culture Tube round bottom 16D 100 len ACCS	12	On request

* Supplied with the unit

ALCOHOL DISTILLATION

- Alcohol distillation via steam dosing to save time
- Compatible with chiller
- Convenient operations with a single encoder push button
- Safe working environment with inbuilt door & tube sensors
- SS steam and acid resistant body generator enhances unit life

Model Name	KDI010
Tube capacity (ml)	250 ml/ 400 ml
Steam addition	Automatic
Display	24 X 7 LCD
Cooling water flow rate sensor	Yes
Drip tray	Yes
Visual reagent level warning	Yes
Steam power	Adjustable
Steam output regulation	25-100%
Maximum distillation time (mins)	20 mins
Tube error detection	Yes
Door close sensor	Yes
Anytime alkali addition	Yes
Control button	Rotary push button
Dimensions (W X D X H)	(380 X 350 X 725) mm
Current consumption (A)	5.5 A
Power consumption (W)	1000W
Voltage	230- 50/ 60 Hz
HSN Code	84790000
Ordering code	BLFAKDI01000000000
Price/ Unit	On request



KDI010

Model Name	CHL500
Tank capacity (L)	7.5
Tank size (mm)	(325x265x150) mm
Cooling capacity (W)	500
Pump flow rate (LPM)	15
Display	LED
Temperature stability	± 0.03 °C
Temperature range	-10 to amb
Overall size (L x W x H) mm	(594 x327 x 596) mm
HSN Code	84198990
Ordering code	BLFRCHL50000000000
Price/ Unit	On request



CHL500

- Use a chiller or ice pack for best extraction

Parameter	Chiller	Ice Pack
Avg distillation time	9.03 mins	10.35 mins
Avg Accuracy	±0.68%	±0.05%
Avg Precision	0.48	0.2
Avg Variance	0.49	0.07
Avg % Recovery	106.30%	102.28%

FAT DETERMINATION APPARATUS : SOXHLET EXTRACTION

- Individual rotary knob for precise setting of temperature and time
- Large character digital display for high visibility.
- SS 304 top plate.
- Chemical and heat resistant body.
- Mounts for safely holding the glass parts.



SOX065 Image used for representation purpose only.
Actual product may differ.

Model Name	SOX012	SOX015	SOX042	SOX045	SOX062	SOX065
Position	1		4		6	
Flask Capacity (ml)	250	500	250	500	250	500
Extractor capacity	100	200	100	200	100	200
Temperature Accuracy	±1°C					
Temperature Uniformity	±15°C					
Plate Temperature	Upto to 320°C					
Safe temperature setting	Yes					
Liquid Temperature	95°C for normal water at 560 m above mean sea level					
Display Timer	1-999 min					
Dimension (W X D X H) mm	200 X 300 X 800		750 X 300 X 800		1050 X 300 X 800	
Weight (Kgs)	7		12		15	
Power (W)	400		1600		2400	
HSN Code	84194090					
Ordering code	BLFRSOX0120000000	BLFRSOX0150000000	BLFRSOX0420000000	BLFRSOX0450000000	BLFRSOX0620000000	BLFRSOX0650000000
Price/ Unit	On request	On request	On request	On request	On request	On request

High Performance Laboratory Water & Oil Bath



EFFICIENT



SECURE



EASY



SCAN TO
KNOW MORE



Manufactured
by
BOROSIL®
TECHNOLOGIES

For more details please refer page no.245

ON DEMAND

Water Distillation Units

Distillation is the most reliable and cost effective method of generating pure water for laboratory uses like reagents, buffer preparations, pH solutions, rinsing, media preparation, in baths, autoclaves etc.

Distillation generates water free of organic, inorganic impurities from feed water without the need to spend large sums on membranes, resins or filters.

Borosil's ON DEMAND Automatic distillation units empowers the user to set the demand for a set volume of pure water. The unit operates automatically to deliver the set volume and turns itself off.

A system prompted step by step guide assists the user in cleaning the unit for an uninterrupted operation. Safety features for auto cut-off in case of water supply failure or boiler overheating.

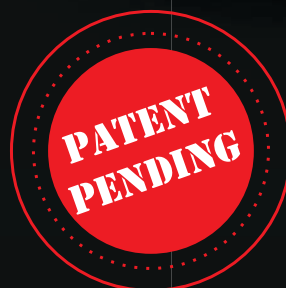

SINGLE DISTILLATION GLASS UNIT

Output Water: Typical Values with potable drinking water as input

Conductivity (S/cm)	< 3 X 10 ⁻⁶
Biological Activity	Pyrogen Free

Technical Details

Model No	SDU150	SDU250	SDU400
Water output	1.5LPH	2.5LPH	4.0LPH
Dimensions (W X D X H)	(650 X 255X 460) mm	(650 X 255X 460) mm	(650 X 255X 460) mm
Weight in Kg	Approx 15Kg	Approx 18Kg	Approx 20Kg

Ordering Information

Model No	Old Model No	Product Code	LPH	Type	Stage	Price/ Unit
SDU150	3361041 with 3366141	BLFRSDU15000000000	1.5	On demand, Automatic	Single Stage	35,500.00
SDU250	3361042 with 3366142	BLFRSDU25000000000	2.5	On demand, Automatic	Single Stage	49,500.00
SDU400	3361032 with 3366132	BLFRSDU40000000000	4.0	On demand, Automatic	Single Stage	55,100.00
3361041	3361041	3361041	1.5	Manual	Single Stage	21,480.00
3361042	3361042	3361042	2.5	Manual	Single Stage	36,450.00
3361032	3361032	3361032	4.0	Manual	Single Stage	42,250.00

DOUBLE DISTILLATION UNITS WITH GLASS BOILER & GLASS CONDENSER

Output Water: Typical Values with potable drinking water as input

Conductivity (S/cm)	< 1 X 10 ⁻⁶
Biological Activity	Pyrogen Free

Technical Details

Model No	DDU150	DDU250	DDU400
Water output	1.5LPH	2.5LPH	4.0LPH
Dimensions (W X D X H) mm	(650 X 630X 520)	(650 X 630X 520)	(650 X 630X 520)
Weight in Kg	Approx 15Kg	Approx 18Kg	Approx 20Kg

Ordering Information

Model No	Old Model No	Product Code	LPH	Type	Stage	Price/ Unit
DDU150	3361041 with 3366241	BLFRDDU15000000000	1.5	On demand, Automatic	Two Stage	56,500.00
DDU250	3361042 with 3366242	BLFRDDU25000000000	2.5	On demand, Automatic	Two Stage	91,100.00
DDU400	3361032 with 3366232	BLFRDDU40000000000	4.0	On demand, Automatic	Two Stage	99,100.00
3362041	3362041	3362041	1.5	Manual	Two Stage	41,750.00
3362042	3362042	3362042	2.5	Manual	Two Stage	76,750.00
3362032	3362032	3362032	4.0	Manual	Two Stage	85,500.00

HS 84194090

Mono Quartz Distillation Unit

The supply of pyrogen-free distilled water is a basic requisite for research, analytical and industrial laboratories. Distilled water from metallic units does not meet the required standards. Moreover, such units are bulky and cumbersome.

Borosil Mono Quartz Distillers are very compact and are constructed of high purity quartz, thereby meeting the standard of analytical laboratories, where the purity of distilled water that is free from metallic ions and bacteria, is the chief criterion.

The boiler is made of high purity quartz and the condenser is made of borosilicate/quartz material. The built-in heater ensures minimum loss of heat, and production of distilled water in 2 to 3 minutes. The Unit is mounted on a powder-coated metal stand with electrical connections, and is easy to dismantle and assemble. The fibre glass insulated wire and silicone rubber boot resist high temperatures.

3363 - MONO QUARTZ DISTILLATION UNIT

Panel Mounted with Quartz Boiler & Borosilicate Condenser, Vertical Model

Particulars/ Model	3363		
Dist. Water output cap (Approx) (Ltr/hr)	2.5	5	10
Minimum cooling water requirement (Ltr/ min)	1	2	2.5
Total Power consumed (Kw)	2.2	4.4	8.8
Conductivity (S/ cm) *	<3 x 10 ⁻⁶	<3 x 10 ⁻⁶	<3 x 10 ⁻⁶
Voltage (V)	230 - 250 V	230 - 250 V	230 - 250 V
Biological Activity	Pyrogen Free	Pyrogen Free	Pyrogen Free
Boiler	Quartz	Quartz	Quartz
Condenser	Borosilicate	Borosilicate	Borosilicate
HSN Code	84194090	84194090	84194090
Product code	3363042	3363033	3363038
Price / Unit - ₹	37,800.00	70,650.00	1,60,650.00

* Inlet water TDS < 100 ppm



STANDARD ACCESSORIES FOR CAT NO. 3363

Product Code	For Cat No.	Output Capacity (Lt/Hr)	Description	HSN Code	Price / Piece ₹
3366342	3363	2.5	Distillation Appartus Power Supply (DAPS)	85362029	12,970.00
3366333	3363	5	Distillation Appartus Power Supply (DAPS)	85362090	14,380.00
3366338	3363	10	Distillation Appartus Power Supply (DAPS)	85362090	26,700.00

SPARES FOR DISTILLATION UNIT FOR CAT NO. 3363

Product Code	For Cat No.	Output Capacity (Lt/Hr)	Description	HSN Code	Price / Piece ₹
363012	3363	2.5	Quartz Boiler	84194090	27,560.00
362022	3363	2.5	Borosilicate Condenser	70179090	4,890.00
363032	3363	5	Quartz Boiler	84194090	50,720.00
0363S00	3363	5	Borosilicate Condenser	70179090	16,750.00
0363S02	3363	10	Quartz Boiler	84194090	88,920.00
0363S03	3363	10	Borosilicate Condenser	70179090	33,880.00

3364 - MONO QUARTZ DISTILLATION UNIT

Panel Mounted with Quartz Boiler And Quartz Condenser,
Vertical Model

Particulars/ Model	3364	
Dist. Water output cap (Approx) (Ltr/hr)	2.5	5
Minimum cooling water requirement (Ltr/ min)	1	2
Total Power consumed (Kw)	2.2	4.4
Conductivity (S/ cm) *	<2 x 10-6	<2 x 10-6
Voltage (V)	230 - 250 V	230 - 250 V
Biological Activity	Pyrogen Free	Pyrogen Free
Boiler	Quartz	Quartz
Condenser	Quartz	Quartz
HSN Code	84194090	84194090
Product code	3364042	3364033
Price / Unit - ₹	64,050.00	1,22,850.00



* Inlet water TDS < 100 ppm

STANDARD ACCESSORIES FOR CAT NO. 3364

Product Code	For Cat No.	Output Capacity (Lt/Hr)	Description	HSN Code	Price / Piece ₹
3366442	3364	2.5	Distillation Apparatus Power Supply (DAPS)	84194090	12,970.00
3366433	3364	5	Distillation Apparatus Power Supply (DAPS)	84194090	14,360.00

SPARES FOR DISTILLATION UNIT FOR CAT NO. 3364

Product Code	For Cat No.	Output Capacity (Lt/Hr)	Description	HSN Code	Price / Piece ₹
363012	3364	2.5	Quartz Boiler	84194090	27,560.00
364023	3364	2.5	Quartz Condenser	70171000	25,580.00
363032	3364	5	Quartz Boiler	84194090	50,720.00
0364S01	3364	5	Quartz Condenser	70171000	58,800.00

All Quartz Double Distillation Unit

The unit consist of Primary Boiler with built-in heater. The Primary Boiler has a 'O' ring groove at the top on which a silicone 'O' Ring sits. The Secondary Boiler with Condenser is mounted on the Primary Boiler.

A Double wall Condenser ensures separate condensation of vapor coming from the two Boilers using a single cooling circuit.

The whole unit is mounted on powder coated stand with Electrical Terminals for easy connection either to the mains or DAPS (Distillation Apparatus Power Supply). The bottom outlet is connected to a 'T' joint of which limb is connected by a rubber tubing & pinch cock for cleaning sediments in Primary Boiler by acid wash and other limb to the water leveler of 'DAPS'.

- Demountable Model - Primary Boiler easy to dismantle
- Innovative Design - "O" Ring with Primary Boiler
- New Condenser Unit - Water inlet & outlet at top of the unit

3365 - ALL QUARTZ DOUBLE DISTILLATION UNIT

Demountable Boiler Panel Series, Vertical Model

Automatic Single Distillation Glass Unit

Particulars/ Model	3365		
	1.5	2.5	5
Dist. Water output cap (Approx) (Ltr/hr)			
Minimum cooling water requirement (Ltr/ min)	1	2	2.5
Total Power consumed (Kw)	3	4.4	8.8
Conductivity (S/ cm) *	<1 x 10 ⁻⁶	<1 x 10 ⁻⁶	<1 x 10 ⁻⁶
Voltage (V)	230 - 250 V	230 - 250 V	230 - 250 V
Biological Activity	Pyrogen Free	Pyrogen Free	Pyrogen Free
Boiler	Quartz	Quartz	Quartz
Condenser	Quartz	Quartz	Quartz
HSN Code	84194090	84194090	84194090
Product code	3365041	3365042	3365033
Price / Unit - ₹	95,550.00	1,92,150.00	3,50,700.00

* Inlet water TDS < 100 ppm

Note : Because of difficulties associated with measurement of the pH value of high purity water and the doubtful significance values obtained, limits for th pH value of grade 1 & grade 2 water have not been specified



STANDARD ACCESSORIES FOR CAT NO. 3365

Product Code	For Cat No.	Output Capacity (Lt/Hr)	Description	HSN Code	Price / Piece ₹
3366541	3365	1.5	Distillation Apparatus Power Supply (DAPS)	85362090	13,670.00
3366542	3365	2.5	Distillation Apparatus Power Supply (DAPS)	85362090	14,360.00
3366533	3365	5	Distillation Apparatus Power Supply (DAPS)	85362090	27,090.00

SPARES FOR DISTILLATION UNIT FOR CAT NO. 3365

Product Code	For Cat No.	Output Capacity (Lt/Hr)	Description	HSN Code	Price / Piece ₹
362013	3365	1.5	Primary Boiler	84194090	26,580.00
362015	3365	1.5	Secondary Boiler	84194090	1,01,580.00
362063	3365	1.5	Receiving Adapter with spring	70179090	1,810.00
362014	3365	2.5	Primary Boiler	84194090	33,140.00
362016	3365	2.5	Secondary Boiler	84194090	1,41,330.00
362063	3365	2.5	Receiving Adapter with spring	70179090	1,810.00
0362S04	3365	5	Primary Boiler	84194090	52,210.00
0363S05	3365	5	Secondary Boiler	84194090	2,73,100.00
362063	3365	5	Receiving Adapter with spring	70179090	1,810.00
362052	3365		Silicon 'O' Ring	40091100	550.00

3370 - CABINET STILL UNIT

- Designed with an inbuilt level sensor and cut-off device in case the water in the Boiler drops below the desired level
- Cleaning is easier due to the integral funnel that facilitates addition of acid to the Boiler and rota-flow stopcock for draining out sediments
- The unique design of the Condenser ensures effective cooling and low distillate temperature
- The acrylic safety screen and cabinet lid are removable, enabling easy access to the glassware components



Particulars/ Model	3372
Dist. Water output cap (Approx) (Ltr/hr)	2.5
Minimum cooling water requirement (Ltr/ min)	2
Total Power consumed (Kw)	1
Conductivity (S/ cm)*	2.2
Distillation Temp (0C)	<2 x 10-6
Voltage (V)	230 - 250 V
Biological Activity	Pyrogen Free
Heater	Quartz
Boiler	Borosilicate Glass
Condenser	Borosilicate Glass
HSN Code	84194090
Product code	3370032
Price / Unit - ₹	77,700.00

* Inlet water TDS < 100 ppm

Product Code	Cat No.	Output Capacity (Lt/Hr)	HSN Code	Price / Piece ₹
3370S01	3370	Borosilicate Boiler With Leveller	70179090	18,230.00
3370S02	3370	Borosilicate Condenser	70179090	13,680.00
3370S03	3370	Quartz B - 50 Heater	84194090	18,230.00
3370S04	3370	DAPS	85362090	24,870.00

Eco MS :

All Glass Single Distillation System

- Single distilled
- With acid addition funnel & drain stopcock
- Unique condenser design for maximum output
- Safety thermostat to prevent over heating in the event of water supply failure

Model	Eco MS
Output per hour	4 Lit / Hr
Typical pH	5.0 - 6.5
Conductivity	3.0 - 4.0
Pyrogen Content*	Pyrogen free
Water Supply	1 Lit / minute, 3 -1 00 psi (20 - 700kPa)
Electricity Supply	220 - 240 V, 50 - 60 Hz, Single Phase
Power Requirement	3 kw
Dimensions (W x D x H)	500 x 150 x 450 mm
Product Code	100336104LG00M
Price	On request

* Inlet water TDS < 100 ppm



STANDARD ACCESSORIES DAPS FOR CAT NO. 3361/3362

Product Code	For Cat No	Output Capacity LPH	Description	HSN Code	Price / Piece
3366141	3361	1.5	Distillation Appartus Power Supply (DAPS)	85362090	12950.00
3366142	3361	2.5	Distillation Appartus Power Supply (DAPS)	85362090	12950.00
3366132	3361	4	Distillation Appartus Power Supply (DAPS)	85362090	12950.00
3366241	3362	1.5	Distillation Appartus Power Supply (DAPS)	85362090	14380.00
3366242	3362	2.5	Distillation Appartus Power Supply (DAPS)	85362090	14380.00
3366232	3362	4	Distillation Appartus Power Supply (DAPS)	85362090	14380.00

SPARES FOR DISTILLATION UNIT FOR CAT NO. 3361/3362

Product Code	For Cat No	Output Capacity LPH	Description	HSN Code	Price / Piece
336011	3361/62	1.5	Borosilicate Boiler with Water Leveller	70179090	6220.00
0336012R	3361/62	1.5	Primary Quartz Heater B-34 (RED)	84194090	6140.00
0336012B	3362	1.5	Secondary Quartz Heater B-34 (BLUE)	84194090	6140.00
361021	3361/62	1.5	Condenser	70179090	4890.00
336031	3361/62	2.5	Borosilicate Boiler with Water Leveller	70179090	8800.00
0336013R	3362	2.5	Primary Quartz Heater B-45 (RED)	84194090	8650.00
0336013B	3362	2.5	Secondary Quartz Heater B-45 (BLUE)	84194090	8650.00
361041	3361	2.5	Condenser	70179090	8540.00
336021	3361/62	4	Borosilicate Boiler with Water Leveller	70179090	15240.00
0336022R	3361/62	4	Primary Quartz Heater B-50 (RED)	84194090	10850.00
0336022B	3362	4	Secondary Quartz Heater B-50 (BLUE)	84194090	10850.00
362021	3361	4	Condenser	70179090	12980.00

3369 - SILICONE TUBING FOR DISTILLATION UNIT & LABORATORY APPLICATION

*Heat Resistance Temperature Range : -40°C To +205°C

Silicone tubing is used for laboratory and industrial applications only. It should not be used for implants , human reproductive system and other medical applications.

336900 - 8mm x 12mm is used for 3361-1.5, 3362-1.5, 3363-2.5 series

3369004 - 10mm x 14mm is used for 3361-4l, 3362-4l, 3364-2.5l, 5l, 3365-1.5l,2.5l,5l, 3363-5l,10l.



Product Code	Size mm	Quantity per case	HSN Code	Price for 10 Meter ₹ in mtr
3369001	4 mm ID x 7 mm OD	10	40091100	1,530.00
3369002	6 mm ID x 9 mm OD	10	40091100	1,990.00
3369003	8 mm ID x 12 mm OD	10	40091100	4,160.00
3369004	10 mm ID x 14 mm OD	10	40091100	5,220.00

WATER BATHS

Elemental Water Bath

- Still and Stirred¹ water baths. (¹External Stirred)
- SS Body construction
- 7 Segment Display
- Auto cut off
- Temperature & Timer Display
- Safety Alarm & Light



WLS Series



WLC Series

Model - Still/Stirred	WLC005/WLS005 ²	WLC012/WLS012 ²	WLC020/WLS020 ²
Nominal capacity	5 L	12 L	20 L
Working Temperature range	Ambient +5°C to 99°C		
Temperature stability	±2.0°C		
Interior dimensions (W x D x H)	(300 x 152 x 150) mm	(330 x 300 x 150) mm	(500 x 300 x 150) mm
Exterior dimensions (W x D x H)	(325 x 180 x 260) mm	(355 x 325 x 260) mm	(550 x 350 x 260) mm
Display	7 Segment LED Display		
Tank material	SS 304		
Outer body	SS 304		
Electrical Requirements	2 A	6 A	9 A
Power Consumption	400 W	1200 W	1600 W
HSN Code	84198990		
Ordering Information	BLFHWLC00500000000	BLFHWLC01200000000	BLFHWLC02000000000
Prices/ Piece	21,900.00	26,900.00	35,900.00
Ordering Information	BLFHWLS00500000000	BLFHWLS01200000000	BLFHWLS02000000000
Prices/ Piece	24,900.00	29,900.00	38,900.00

²WLS comes with overhead stirring.

WLC020 and WLS020 are provided with drain option.

WLC and WLS Water Bath are Supplied Without Cover.

ACCESSORIES

Order No.	Ordering Code	Suitable for	Price in ₹
5 Ltr			
BLAHWLC005LID00003	3 Hole WLC005 SS LID Assembly	WLC005	1355.00
BLAHWLS005LID00002	2 Hole WLS005 SS LID Assembly	WLS005	1700.00
BLAHWLC005PCLID000	WLC005 Polycarbonate LID Assembly	WLC005	3500.00
BLAHWLS005BALLID00	WLS005 BALL Shield Assembly	WLS005/ WLC005	1390.00
12 Ltr			
BLAHWLC012LID00006	6 Hole WLC012 SS LID Assembly	WLC012	2310.00
BLAHWLS012LID00006	6 Hole WLS012 SS LID Assembly	WLS012	2700.00
BLAHWLC012PCLID000	WLC012 Polycarbonate LID Assembly	WLC012	4155.00
BLAHWLS012BALLID00	WLS012 BALL Shield Assembly	WLS012/ WLC012	2465.00
20 Ltr			
BLAHWLC020LID00008	8 Hole WLC020 SS LID Assembly	WLC020	3235.00
BLAHWLS020LID00008	8 Hole WLS020 SS LID Assembly	WLS020	5235.00
BLAHWBA012CAPPC000	12 Ltr Polycarbonate Lid ASM	WLC020	5390.00
BLAHWLS020BALLID00	WLS020 BALL Shield Assembly	WLC020/ WLC020	3540.00

Premium Water Baths

- Seamless Stainless Steel Pan
- Data Logger - USB Provision
- Inbuilt Water Level Sensor
- Supplied with non corrosive rings lid upto 24L
- Stirring with PTFE Magnetic Bar
- External PT100 Sensors - for measuring solution temp



WBP012

WBP020

Stirred Models	WBP012	WBP020
Nominal capacity	12L	20L
Working Temperature range	Ambient +5°C to 99°C	
Temperature stability	±0.2°C	
Interior SS304 dimensions* (W x D x H)	330 x 300 x 150	500mm x 300mm x 150mm
Exterior SS304 dimensions* (W x D x H)	355mm x 325mm x 260mm	550mm x 335mm x 260mm
Electrical Requirements	8 A	6 A
Power Consumption	1200 W	2000 W
Supplied With Concentric Rings Lid	4 Position	8 Position
HSN Code	84198990	
Ordering Information	BLFHWP012000000000	BLFHWP02000000000
Prices/ Piece	On Request	On Request

HIGH CAPACITY CIRCULATING WATER BATH

Model	WBP024	WBP035	WBP060
Nominal capacity	24 L	35 L	60 L
Working Temperature range	Ambient +5°C to 99°C	Ambient +5°C to 95°C	
Temperature stability	±0.2°C	±0.2°C	±0.2°C
Interior dimensions (W x D x H)	(500 x 300 x 200) mm	(650 x 530 x 150) mm	(650x530x200) mm
Exterior dimensions* (W x D x H)	(550 x 335 x 310) mm	(675x 645 x 425) mm	(675x645x475) mm
Electrical Requirements	10 A		13 A
Power Consumption	2200 W	2200 W	2900 W
Supplied With Concentric Rings Lid	8 Position	SS Hinged Canopy	
HSN Code	84198990		
Ordering Information	BLFHWP02400000000	BLFHWP03500000000	BLFHWP06000000000
Prices/ Piece	On request	On request	On request

SEROLOGICAL WATER BATH

- Special design for incubation cells & serum culture sample
- 200 mm additional water tank height
- Seamless stainless steel Pan
- In built water level sensor



WBP015

Model	WBP015
Nominal capacity	15 L
Working Temperature range	Ambient +5°C to 99°C
Temperature stability	±0.2°C
Interior dimensions (W x D x H)	(330 x 300 x 200) mm
Exterior dimensions* (W x D x H)	(355 x 325 x 510) mm
Electrical Requirements	3A
Power Consumption	550W
Supplied with lid	Polycarbonate lid
HSN Code	84198990
Ordering Information	BLFHWBP01500000000
Prices/ Piece	On request

ACCESSORIES



BLMHWBA01200000008



BLMHWBA020CAPP000



BLMHWBA012CAP0PC00

Order No.	Product Discription	HSN Code	Pack of	Price in ₹
WBP Series - 12 L				
BLMHWBA05000000004	SS LID with Glass Nylon Concentric Rings- 04 Holes	84198990	1	2,810.00
BLMHWBA05000000006	SS LID with Glass Nylon Concentric Rings- 06 Holes	84198990	1	3,750.00
BLMHWBA050CAPP000	Polycarbonate Moulded Lid	84198990	1	3,210.00
WBP Series - 20 L & 24 L				
BLMHWBA01200000008	SS LID with Glass Nylon Concentric Rings-08 Holes	84198990	1	6,420.00
BLMHWBA01200000012	SS LID with Glass Nylon Concentric Rings-12 Holes	84198990	1	8,340.00
BLMHWBA012CAPP000	Polycarbonate Moulded Lid	84198990	1	5,570.00



OMC250 & OMS250

OMC010& OMS010

OIL BATH / CIRCULATING OIL BATH

- S.S body construction
- 4 digit 7 segment LED display for displaying temperature and time
- External probe is used for better temperature accuracy
- S.S perforated tray for holding flasks
- Easy cleaning inside the cylinder body after heating of oil

Model	OMC250/OMS250	OMC010/OMS010	OMS020*
Flask Capacity	250 ml	1 L	1 L to 2 L
Nominal capacity	750 ml	3057 ml	7.5 L
Temperature stability Water Bath	±1°C		
Working Temperature range for Oil Bath	Ambient +5°C to 240°C with 0.1°C increments		
Temperature stability Oil Bath	±1°C		
Interior dimensions* (Dia. x H)	(120 x 86) mm	(182 x 142) mm	(217 x 209) mm
Exterior dimensions* (W x D x H)	(203 x 169 x 206) mm	(273 x 240 x 263) mm	(302 x 280 x 410) mm
Electrical Requirements	1.5 A	4 A	2.5 A
Power Consumption	300 W	800 W	1500 W
Supplied With Lid	1 Position		
HSN Code	84198990		
Ordering Information Still	BLFHOMC25000000000	BLFHOMC01000000000	-
Prices/ Piece	23,600.00	27,400.00	-
Ordering Information Circulating	BLFHOMS25000000000	BLFHOMS01000000000	BLFHOMS02000000000
Prices/ Piece	26,500.00	30,300.00	On request

Gen2 Heating Mantles

- Energy regulator setting with single segment LED display
- Automatic spill detection and safe shut-down



GME010

Model	GME250	GME500	GME010
Flask Capacity	250 ml	500 ml	1 L
Flask Diameter	85 mm	105 mm	135 mm
Exterior dimensions* (W x D x H)	(310 x 330 x 160) mm		
Working Temperature range	Ambient +5°C to 420°C		
Display	LED Display with time, temperature & process status		
Electrical Requirements	1 A	1 A	1.5 A
Power Consumption	150 W	200 W	300 W
HSN Code	84198990		
Ordering information	BLFHGME25000000000	BLFHGME50000000000	BLFHGME01000000000
Prices/ Piece	3,060.00	3,200.00	3,310.00

Product carries no warranty.

Gen2 Precision Heating Mantles

- Digital energy regulator with 10 step power regulation
- Automatic spill detection and safe shut-down
- In built precision temperature control and energy regulator mode



GMC010

Model	GMC250	GMC500	GMC010
Flask Capacity	250 ml	500 ml	1 L
Flask Diameter	85 mm	105 mm	135 mm
Exterior dimensions* (W x D x H)	(310 x 330 x 160) mm		
Working Temperature range	Ambient +5°C to 420°C		
Display	LED Display with time, temperature & process status		
Temperature Accuracy	±1.0°C		
Timer	0-999 Minutes		
Electrical Requirements	1 A	1 A	1.5 A
Power Consumption	150 W	200 W	300 W
HSN Code	84198990		
Ordering information	BLFHGMC25000000000	BLFHGMC50000000000	BLFHGMC01000000000
Prices/ Piece	4,170.00	4,310.00	4,420.00

Product carries no warranty.

PRECISION HEATING MANTLES

- Temperature accuracy of $\pm 1^{\circ}\text{C}$ with auto cut off
- Thermally insulated, electrically grounded and powder coated metal body
- Stainless steel top plate for corrosion resistant handling
- Quick clamp feature for easy heating element replacement



HMC020

Model	HMC020	HMC050	HMC011
Flask Capacity	2 L	5 L	10 L
Flask Diameter	166 mm	255 mm	279 mm
Working Temperature range	Ambient +5°C to 420°C	Ambient +5°C to 420°C	Ambient +5°C to 420°C
Display	LED Display with time, temperature & process status	LED Display with time, temperature & process status	LED indication with energy Setting from 0-9
Temperature Accuracy	$\pm 1.0^{\circ}\text{C}$	$\pm 1.0^{\circ}\text{C}$	$\pm 1.0^{\circ}\text{C}$
Timer	0-999 Minutes	0-999 Minutes	0-999 Minutes
Exterior dimensions* (W x D x H)	(263 x 355 x 136) mm"	(430 x 335 x 170) mm	(450 x 603 x 215) mm
Electrical Requirements	2.5 A	3 A	6 A
Power Consumption	450 W	600 W	1200 W
HSN Code	84198990	84198990	84198990
Ordering Information	BLFHMC0200000000	BLFHMC0500000000	BLFHME0110000000
Prices/ Piece	27,200.00	37,900.00	On request

PRECISION HEAT & STIR MANTLE

- **Energy & Speed** regulator for temperature control
- Thermally insulated, electrically grounded and powder coated metal body
- Stainless steel top plate for corrosion resistant handling
- Quick clamp feature for easy heating element replacement

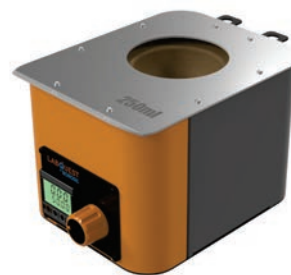

PRM250

Model	PRM250	PRM500	PRM010	PRM020
Flask Capacity	250 ml	500 ml	1 L	2 L
Flask Diameter	85 mm	105 mm	131 mm	166 mm
Working Temperature range	Ambient +5°C to 450°C			
Display	LED indication for process status			
Temperature Accuracy	±1.0°C			
Speed	200-2200 rpm			
Exterior dimensions (W x D x H)	(225 x 170 x 150) mm		(265 x 335 x 200) mm	
Electrical Requirements	1 A		2 A	
Power Consumption	150 W	200 W	300 W	450 W
HSN Code	84198990			
Ordering information	BLFHPRM25000000000	BLFHPRM50000000000	BLFHPRM01000000000	BLFHPRM02000000000
Prices/ Piece	23,600.00	24,700.00	27,000.00	27,600.00

PRM for 5 L , 10 L available on request

LAB - STIRRERS

MAGNETIC HOT PLATE STIRRER

- Temperature range upto 300°C
- Maximum Stirring Capacity upto 2L
- Speed Range 200 - 1500 rpm



HLS200

Model	HLS200
Stirring Position	One
Max Capacity	2 L
Temperature Range	Ambient +5°C to 300°C
Temperature Accuracy	±1°C
Temperature Control	PID and Digital Energy Regulator Mode
Supplied with External & Internal Probe	PT 100
Heater capacity	300 wattage
Speed Range	200 to 1500 rpm
Set up Plate Diameter	150 x 150 mm
Set up Plate	SS Top Plate
Dimensions (L x W x H)	(260 x 190 x 155) mm
Protection Class	IP21
HSN Code	84798200
Ordering Information	BLFHLS20000000000
Prices/ Piece	8,700.00

ACCESSORIES

Product Code	Description	List Price
BLA0DIN00MX0005PIN*	PT100 DIN Connector	2,000.00

* Supplied with unit

MAGNETIC HOT PLATE STIRRER

- Temperature range upto 200°Celsius
- Maximum Stirring Capacity upto 2L
- Speed Range 100 - 1500 rpm
- Temperature accuracy $\pm 10^{\circ}\text{C}$



HPS050

Model	HPS050	HPS051
Stirring Position	One	
Max Capacity	5 L	
Temperature Range	Ambient +5°C to 320°C	
Temperature Accuracy	$\pm 1^{\circ}\text{C}$	
Plate Temperature	upto 320°C	
Temperature Control	PID	
Supplied with External Probe	PT 100 with stand	
Max Speed	1500 rpm	
Motor Type	BLDC MOTOR	
Display Timer	0-999 min	
Set up Plate Diameter	135 mm	
Set up Plate	SS 304 Top Plate	Ceramic Coated Top Plate
Dimensions (L x W x H)	(270 x 200 x 100) mm	
Protection Class	IP21	
Heater Power	550W	
HSN Code	90278090	
Ordering Information	BLFHHP050500000000	BLFHHP051000000000
Prices/ Piece	On request	On request

ACCESSORIES

Product Code	Description	List Price
BLA0DIN00MX0005PIN*	PT100 DIN Connector	2,000.00

* Supplied with unit

MAGNETIC HOT PLATE STIRRER

The nano crystalline ceramic glass-top provides excellent resistance to thermal shock and corrosive liquids. The elevated design, protects the unit from spillages. Best in class capacity and speed of 20 lit and 2200 rpm. The unit comes with slip detection that can recover the stir bar in the event of it being lost outside the magnetic field.

The target temperature can be achieved in rapid or gradual or accurate modes depending upon the application. The unit can also be programmed to meet custom temperature and time conditions.



MHPS350

Model	MHPS 350	MHPS 550
Max capacity in lit	10/20	
Max speed (rpm)	2200	
Temp range (from ambient)	350°C	550°C
Plate Temperature	280°C	450°C
Liquid Temperature	180°C	280°C
Stirring positions	One	
Set up plate	Ceramic	
Protection class	IP21	
Dimension (W X D X H) mm	(220 x 330 x 115) mm	
HSN Code	84198990	
Set up plate in mm	(180 x 180) mm	
Display	Digital	
HSN Code	84198990	
Ordering Information	100MHPS0103500	100MHPS0105500
Prices/ Piece	On request	On request

ACCESSORIES

Product Code	Description	List Price
100MHPS01PT100*	PT 1000	6,800.00
100MHPS01PS000*	Probe Stand	1,700.00

* Supplied with unit

MULTI POSITION STIRRERS

Multi position stirrers with slip-less speed regulation, homogenous temperature distribution and brushless motor for maintenance free operation.

The closed design allows for easy cleaning, safety and protection against spillage.



Model	MHPS 5P	MHPS 10P	MHPS 15P
Stirring positions	5	10	15
Max Speed (rpm)		1500	
Speed range in rpm		digital	
Motor type		BLDC	
Max capacity in lit	2	4	6
Temp range (from ambient)		120°C	
Dimension (W X D X H)	(562 x 136 x 75) mm	(568 x 196 x 75) mm	(568 x 282 x 76) mm
Set up plate	(456 x 118) mm	(460 x 178) mm	(460 x 264) mm
Pulse mode		Yes	
Ordering Information (with heating)	100MHPS0515000	100MHPS1015000	100MHPS1515000
Prices/ Piece	On request	On request	On request

MOTORLESS MAGNETIC STIRRERS

Truly maintenance free with no moving parts. Ultra thin design just 12 mm thick. The SS top surface provides protection against damage due to spillage.



MS ONE



MS FOUR

Model	MS One	MS Four
Max Speed (rpm)	1500	1200
Increment speed (from 15 rpm)	50 rpm	50 rpm
Display	digital	
Max load (ml)	800 ml	250 ml x 4
Magnetic bar length (mm)	25 mm	
Pulse	Yes	
Dimension (W X D X H)	(156 x 110 x 13.2) mm	(457 x 126 x 13.4) mm
Protection class	IP64	
Stirring Position	One	Four
HSN Code	84198990	
Ordering Information	100MS000115000	100MS000412000
Prices/ Piece	13,000.00	26,000.00

ACCESSORIES - Magnetic Stir Bar

Product Code	Description	Recommended Bar	Pack Size	List Price
100MSA0BL08025	Accessory Stir Bar D: 8 mm X 25 mm	Motorless stirrers, Multi position stirrers, MHPS350/ MHPS550	10 pcs	3,480.00
100MSA0BL08035	Accessory Stir Bar D: 8 mm X 35 mm	MHPS350/ MHPS550	10 pcs	3,690.00
100MSA0BL12050	Accessory Stir Bar D: 12 mm X 50 mm	MHPS350/ MHPS550	10 pcs	10,850.00
100MSA0BL13060	Accessory Stir Bar D: 13 mm X 60 mm	MHPS350/ MHPS550	1 pc	1,630.00

MAGNETIC STIRRER

Ativ series - Magnetic Stirrer

- Maximum Stirring Capacity upto 2L
- Speed Range 200 - 2200 rpm



MGS001

Model	MGS001
Stirring Position	One
Max Capacity	2 L
Speed	200-2200 rpm
Display	LED Display
Plate Material	SS304
Plate Dimension in mm	(189 x 208) mm
Unit External Dimensions (W x D x H)	(284 x 188 x 120) mm
Timer	0-999 min
Current Consumption	1 A
Power Consumption	24 W
HSN Code	90278090
Ordering Information	BLFHMG00100000000
Prices/ Piece	6,650.00

MID-STIR

- Stirring quantity up to 50 liters (H₂O)
- Flat, sturdy stainless steel casing
- Infinitely variable speed
- Digital LED speed display
- Slip Detection Enabled



MLS050

Model	MLS050
No of stirring positions	1
Stirring quantity	10L - 50L
Moter Type	BLDC
Stirring bar length	120 mm Max
Material Housing	Flat, sturdy stainless steel 304
Display	4 Digit 7 Segment LED Display
Speed range	100-1000 rpm
Timer	999 minutes along with infinite time
Set-up plate dimensions	(370 x 370) mm
Dimensions (W x D x H)	(430 X 370 X 100) mm
Weight of the product	7 kg
Direct Load Capacity	Max Load 70 kg
Slip Detect	YES
Temperature Range	10°C to 45°C
Power input AC	200 - 240V, 50 Hz
Max current	2 Amps
HSN Code	90278090
Ordering Information	BLFHMLS05000000000
Prices/ Piece	On request

MAX-STIR

- Stirring quantity up to 200 litres (H₂O)
- Flat, sturdy stainless steel casing
- Infinitely variable speed
- Digital LED speed display
- Slip Detection Enabled
- USB output to printer (optional)

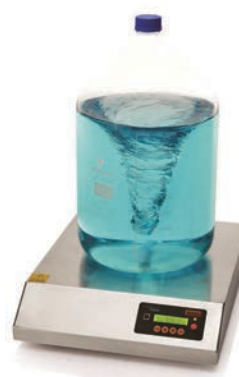

MGS050

Model	MGS020	MGS050	MGS200
Number of stirring positions	1		
Stirring quantity	Upto 20 L	Upto 50 L	Upto 200 L
Motor Type	BLDC 15 MOTOR	BLDC 30 MOTOR	
Stirring bar length	35 - 80 (in mm)	80 - 120 (in mm)	155 (in mm)
Material Housing	304 Stainless steel		
Display	Digital LCD Display		
Speed range	0 - 1000 rpm		0 - 600 rpm
Timer	(0 - 99:99 hrs:min) or continuous/infinite operation		
Set-up plate dimensions	(300 x 300) mm	(400 x 400) mm	(500 x 500) mm
Dimensions (W x D x H)	(300 x 390 x 110) mm	(400 x 490 x 110) mm	(500 x 590 x 110) mm
Weight of the Product	12 Kg	14 Kg	25 Kg
Weight/load (it can Sustain)	30 Kg	70 Kg	70Kg
Indirect Load It can Sustain	Volumes upto 20L	Volumes upto 50L	Volumes upto 200L
Ramp rate	Adjustable for different viscosity		
USB Interface (Upgradable)	YES - Option to connect LABQUEST Data Logger & Printer		
Permissible temperature	Ambient to 40 °C		
Max Current	0.3 A	0.5 A	
Motor rating output	30W	60W	
HSN Code	90278090		
Ordering Code	BLFHMG02000000000	BLFHMG05000000000	BLFHMG20000000000
Prices/ Piece	On request		

HOT PLATE

Model Name	HPL400
Max Capacity	2 L
Heater wattage	400 W
Temperature Accuracy	±1°C
Plate Temperature	Upto to 300°C
Safe temperature setting	Yes
Liquid Temperature	95°C for normal water at 560 m above mean sea level
External Temperature Probe	PT 100
Display Timer	1-999 min & Continuous
Unit External Dimensions (W x D x H)	(284 x 188 x 135) mm
Set up Plate Dimension	(150 x 155) mm
Set up Plate	SS 304 Top Plate
Power consumptions	405 W
Current consumption	2 A
HSN Code	84798200
Price	6,250.00



DRY BATH

- Anodised Aluminium Block
- Digital LED display
- Uv Resistant Top Cover
- Rotary Knob For Ease of Operation



* Representative image
Dry Bath LBH010 supplied
without aluminum block

Model	LBH010
Temperature Range	Ambient +5°C to 130°C
Temperature Accuracy	±0.5°C at 37°C
Display Resolution	±0.1°C
Heating Up Time	≤18 min 30°C TO 130°C
Process Timer	0-999 min
Temperature Control	PID and Digital Energy Regulator
Unit External Dimensions (W x D x H)	(285 x 190 x 156) mm
Cover For DryBlock	UV protection
Power consumptions	200 W
Current Consumption	1 A
HSN Code	84198990
Ordering Information	BLFHLBH01000000000
Prices/ Piece	On request

8 well PCR strip of 0.2 ml,
32 wells, f6.35mm, depth 19mm
BLAALBHPCR3208W004



For 0.5 ml tube,
24 wells, φ8.0mm, depth 25mm
BLAALBH0MW2406W004



FOR 2.0 ml or 1.5ml tube
16 wells of , φ11.0mm, depth 30mm
BLAALBH0MW1604W004



Versatile multi well block
for 8 wells of 0.2ml tube, 8 wells
of 0.5ml tube, and 8 wells of
2.0ml or 1.5ml tube
BLAALBH0MW000BB004



15 ml tube*
12 wells φ17.3mm, depth 50mm
BLAALBH0MW1204W004



For 50 ml tube
4 wells, φ29.2mm, depth 50mm
BLAALBH0MW0402W004



Bead bath or water bath block
Vol of 300ml*
BLAALBH0MW000BB004



Flat **96 well** plate block
BLAALBH0MW0096W004



*During usage of 15ml, 50 ml & 96 Well Plate Aluminum Block, Cover remains open

Product Code	Aluminium Blocks	Prices/ Piece
BLAALBHPCR3208W004	LBH010 ALU Block-8X4 Well PCR Strip Tube	5,150.00
BLAALBH0MW2406W004	LBH010 ALU Block- 6X4 Well, 0.5ml Tube	5,150.00
BLAALBH0MW1604W004	LBH010 ALU Block-4X4 Well, 1.5/2.0ml Tube	5,150.00
BLAALBHVMW0008W004	LBH010 ALU Block Multi Well - 8 Wells	5,150.00
BLAALBH0MW1204W004	LBH010 ALU Block-4X3 Well, 15ml Tube	5,150.00
BLAALBH0MW0402W004	LBH010 ALU Block-2X2 Well, 50ml Tube	5,750.00
BLAALBH0MW000BB004	LBH010 ALU Bead Bath/Water bath block (w/o beads)	5,150.00
BLAALBH0MW0096W004	LBH010 ALU Flat 96 Well plate block	5,150.00

LABWARE DRYER

- Optimum air circulation that dries labware in less than 15 mins
Perfectly dried labware for error free experiments
- Benchtop and Wall mountable unit
- Assorted stainless steel easy to clean Pegs
- Heater (ON / OFF) feature for drying plasticware



Model	GDS010
Number of Pegs	22
Peg Sizes (Volume compatibility)	16
16 mm	12 Nos
10 mm	10 Nos
Temperature Range (0C) Time Control	Ambient to 70°C
Time Control	Yes
Drying Power	1075 W
Dimension (W x D x H)	(400 x 367 x 620) mm
HSN Code	84798200
Ordering information	BLFGGDS01000000000
Prices/ Piece	21,000.00

Product Code	Description	HSN Code	Nos Pcs	Prices ₹
BLPGGDS01000000010	Pegs For Volumetric Adapter -10ID	39260000	10	3,500.00
BLPGGDS01000000016	Pegs For Volumetric Adapter-16ID	39260000	12	4,000.00

VORTEX MIXER

- Touch & Continuous Mode
- Overload & Over Current Protection
- AC Motor For Quick Acceleration & Low Maintenance Easy Recognition of Mixing Mode With In build LED Lamp



BHRMI 2.0

Model	BHRMI 1.0	BHRMI 2.0
Speed	500 to 2800 rpm	300 to 2800 rpm
Orbital diameter	6 mm	
Operational mode	Touch, Stand-by & Continuous mode	
Timer Setting	NA	0 -999 min
Display	NA	LED with rpm & time
Feet	Four suction cups	
Unit External Dimension (W x D x H)	(132x160 x180) mm	
Power consumption	55 W	56 W
Current consumption	1 A	1.5 A
HSN Code	84798200	84798200
Ordering Information	BLFHVMX01000000000	BLFHVMX02000000000
Price per piece / unit	6,450.00	9,450.00

ACCESSORIES BHRMI 1.0 & 2.0

Included



Rubber Cup
BLAHVMX01040000000

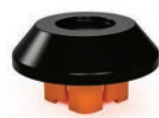

Flat Foam
BLAHVMX01050000000

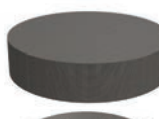

Vial Holder
BLAHVMX01000000001

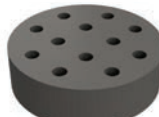

Foam Holder
BLAHVMX01010000007



Optional

Accessories for 96 WELL PLATE

Ordering code (Combine) BLAHVMX02060000000

Microplate holder



Well plate locking belt



Accessories for VOLUMETRIC FLASK

Ordering code (Combine) BLA0EVA000FOAM0VMX

25, 50, 100ml Volumetric Flask Belt

Volumetric flask Base foam



Volumetric Flask Belt Locker

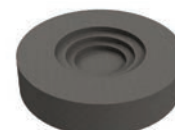

Foam Holder



Product Code	Accessories 1.0 & 2.0	Order Description	List Price
BLAHVMX01040000000	INCLUDED	Rubber Cup	670.00
BLAHVMX01050000000		Flat Foam	390.00
BLAHVMX01000000001		Vial Holder	400.00
BLAHVMX01010000007		Foam Holder	610.00
BLAHVMX02060000000	OPTIONAL	EVA Vial Holder foam	1,140.00
BLA0EVA000FOAM0VMX		Attachment Volumetric Flask	880.00

MULTI TUBE VORTEXER

- Stainless Steel 304 Body
- USB Port to Integrate LabQuest Data Logger
- User Programmable ramp setting



Model	MTV012
Type of Product	Multi-Tube Vortex Mixer
Orbital Diameter (mm)	6 mm
Speed range (rpm)	50 - 2200 rpm
Speed Accuracy	±50 rpm
Operation Mode	Pulse & Continuous mode
Maximum Load	4.0 Kg
Digital time setting	1 min - 999 min & Infinite
Dimensions (mm)	(450 x 245 x 475) mm
Weight (Kg)	24 Kg
Power	60W
Power Supply	AC 100-240V, 50/60Hz
HSN Code	84798200
Order No	BLFHMTV01200000000
Prices/ Piece	On request

ACCESSORIES

Product Code	Description	List Price
BLA0FOAMMTV0000003*	MTV012 50ML TUBE HOLDING FOAM	6,500.00
BLA0FOAMMTV0000004 *	MTV012 15ML TUBE HOLDING FOAM	6,500.00
BLA0FOAMMTV0000005*	MTV012 07ML TUBE HOLDING FOAM	6,500.00
BLA0FOAMMTV0000006	250ml CONICAL FLASK HOLDING FOAM*	6,500.00
BLA0FOAMMTV0000007	100ml VOLUMETRIC FLASK HOLDING FOAM*	6,500.00

* Supplied with unit

MICRO CENTRIFUGE

- LabQuest micro centrifuges are engineered for advanced Aerodynamics to ensure low heat generation due to air friction and low noise operation.
- Safety features include imbalance detection with auto cut-off.
- Electronic brake for auto stop on lid opening. Rotor and adaptors are supplied as standard accessories.



Model	MCF08VT	HMCF12VT
Rotor position	8	12
Tube capacity in ml	1.5 / 2.0 / 0.2 / 0.5	
Max speed (rpm)	6000	15000
RCF	2000	15596
Display	Digital	
Noise level	< 55 db	< 60 db
Imbalance detection	No	Yes
Dimension (W X D X H)	(162 x 157 x 116) mm	(260 x 244 x 205) mm
Weight	1.1 Kg	4 kg
Product Code	100MCF00800VT0	100HMCF1200VT0
Price / Unit	12,000.00	On request

CLINICAL CENTRIFUGE

- Centrifuges for clinical applications are designed to accommodate rotors and centrifuge tubes of varied sizes.
- The CCF 4000VT is designed to accommodate both a swing out rotor for improved separation as well as a 16 position rotor for high throughput while still remaining compact.
- The DCF06VT provides a modern but economical centrifuge for basic clinical separations.



DCF06VT

CCF4000VT

Model	DCF06VT	CCF4000VT	CCF4000VT
Rotor position	Fixed angle	Swing-out	Fix
Tube capacity in ml	5 / 7 / 9 / 15 x 6 Tubes	10 x 6 Tubes	15 x 8
Max speed (rpm)	6500	4000	4000
Lid lock safety	Yes		
Liquid Temperature	Digital		
Stirring positions	Yes		
Dimension (W X D X H)	(260 x 244 x 205) mm	(415 x 355 x 173) mm	(415 x 355 x 173) mm
HSN Code	84198990	84198990	84198990
Ordering Information	100DCF00600VT0	100CCF00800VT0	On request
Prices/ Piece	On request	On request	On request

ACCESSORIES

Product Code	Description	Price / Unit - ₹
100CCFA0610MLS*	Rotor for CCF 8 swing, 10 ml x 6	10,500.00
100CCFA0815MLF	Rotor for CCF 8 fix, 15 ml x 8	10,500.00
100CCFA1610MLF	Rotor for CCF 8 fix, 10 ml x 16	10,500.00

* Supplied with the unit

SHAKERS

- 7500S / PL FOUR / 15000S.
- Shakers produce true linear or orbital motion using brush less dc motors.
- Digital display and soft touch control panel interface for fatigue free convenience. Microprocessor control allows for custom programming of speed and time.
- The platform shaker 7500S can handle a mass of 7.5 Kg

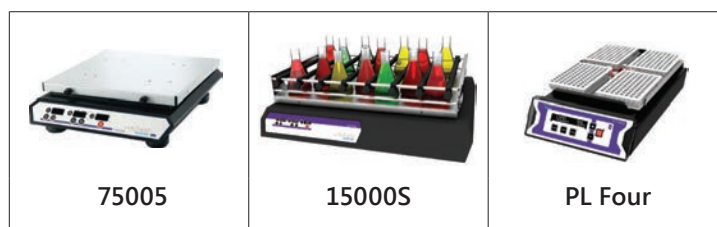

Model	7500S	15000S	PL Four
Type of movement	Orbital / Linear		Orbital
Orbital diameter in mm	10	30, 40, 40, 60, 70	4
Speed range in rpm	50-500	30 - 300	100-1200
Motor type	BLDC		
Display	digital		
Run time	0-99 hrs and 0-60 min	Upto 99hours 59 mins	1-999 min and infinite
Dimensions (WXDXH)	(350 x 408 x 105) mm	(825 x 625 x 165) mm	(343 x 195 x 88) mm
HSN Code	84798200		
Ordering Information	100S0000075000	100S0000150000	100PL000400000
Prices/ Piece	On request	On request	30,000.00

ACCESSORIES

for Shaker 7.5 Kg

Product Code	Description	List Price
100S00009UPB75*	Universal platform with adjustable bars (Flask capacity 9 x 250 ml, 6 x 500 ml)	8,200.00
100S02509BPP75	Base plate with 9 plastic clamps : 9 x 250 ml	8,200.00
100S05009BPP75	Base plate with 9 plastic clamps : 9 x 500 ml	8,800.00
100S01009BPS75	Base plate with 9 Stainless steel clamps : 9 x 100 ml	10,000.00
100S02509BPS75	Base plate with 9 Stainless steel clamps : 9 x 250 ml	10,300.00
100S05009BPS75	Base plate with 9 Stainless steel clamps : 9 x 500 ml	12,400.00
100S01001SSC00	Stainless steel Clamp for 100 ml flask	600.00
100S01501SSC00	Stainless steel Clamp for 150 ml flask	620.00
100S02501SSC00	Stainless steel Clamp for 250 ml flask	620.00
100S05001SSC00	Stainless steel Clamp for 500 ml flask	1,170.00
100S10001SSC00	Stainless steel Clamp for 1000 ml flask	1,430.00
100S00000FA075	Funnel Attachment	10,600.00

for Shaker 15 Kg

Product Code	Description	MRP
100S00UP150000*	Shakers 15 kg Universal Platform for 44 x 100 ml, 36 x 250 ml, 25 x 500 ml, 13 x 1000 ml	44,600.00
100S0BPC150015	Shaker 15 Kg Base Plate for Plastic Clamps for 24 x 250 ml, 24 x 250 ml	29,500.00
100S02501PC015	Shaker 15 Kg Plastic Clamp 1 No 250 ml	770.00
100S05001PC015	Shaker 15 Kg Plastic Clamp 1 No 500 ml	990.00
100S0BSC250015	Shaker 15 Kg Base Plate for SS Clamps 24 x 100 ml, 24 x 150 ml, 24 x 250 ml	26,510.00
100S01001SC015	Shaker 15 Kg SS Clamp 1 No, 100 ml	990.00
100S01501SC015	Shaker 15 Kg SS Clamp 1 No, 150 ml	1,210.00
100S02501SC015	Shaker 15 Kg SS Clamp 1 No, 250 ml	1,210.00
100S0BSC100015	Shaker 15 Kg Base Plate for SS Clamps 24 x 500 ml, 8 x 1000 ml	26,510.00
100S05001SC015	Shaker 15 Kg SS Clamp 1 No 500 ml	1,760.00
100S10001SC015	Shaker 15 Kg SS Clamp 1 No 1000 ml	2,000.00

CHILLER

Chiller + Heater

- Ergonomic and compact design allows the instruments to be on desk at eye-level
- Large, bright LED display with reliable microprocessor PID temperature control
- Economic and environmental friendly operation
- Simple operation and navigation menu



CTR 175

Model	CTR 175	CTR 500	CTR101
Tank capacity	5 L	7.5 L	10 L
Tank size (L x W x D) mm	(325x176x150) mm		(325x265x200) mm
Cooling capacity	175 W	500 W	1000 W
Pump flow rate	12.5 LPM		
Heater capacity (Watt)	1200 W	1800 W	
Display	LED		
Temperature stability	± 1.0 °C		
Temperature range	-10°C to 100°C		
HSN Code	84198990		
Ordering Information	BLFRCTR17500000000	BLFRCTR50000000000	BLFRCTR01000000000
Prices/ Piece	On request		

Chiller

- Temperature range from -10°C to ambient -5 °C
- Ergonomic and compact design allows the instruments to be on desk at eye-level
- Large, bright LED display with reliable microprocessor PID temperature control
- Economic and environmental friendly operation
- Simple operation and navigation menu



CHL010

Model	CHL175	CHL500	CHL010
Tank capacity	5 L	7.5 L	10 L
Tank size (L x W x D) mm	(325x176x150) mm	(325x265x150) mm	(325x265x200) mm
Cooling capacity	175 W	500 W	1000 W
Pump flow rate	12.5 LPM		
Heater capacity (Watt)	1200 W	2000 W	2000 W
Display	LED		
Temperature stability	± 1.0 °C		
Temperature range	-10 °C to ambient -5 °C		
HSN Code	84198990		
Ordering Information	BLFRCHL17500000000	BLFRCHL50000000000	BLFRCHL01000000000
Prices/ Piece	On request		

ACCESSORIES

Product Code	CTR 005	List Price / Mtr
BLA0STT4D00006TRNP	Silicon Tube : 4 mm ID x 06 mm OD	480.00
BLA0STT8D00012TRNP	Silicon Tube : 8 mm ID x 12 mm OD	630.00
BLA0TUB100SILC1014	Silicon Tube : 10 mm ID x 14 mm OD	700.00
BLA0VRT8D00012DBLK	Viton Rubber Tube : 8 mm ID x 12 mm OD	1,580.00
BLA0VRT10D0014DBLK	Viton Rubber Tube : 10 mm ID x 14 mm OD	1,680.00
BLA0PIPPVC0HOS00CB	Clear Braided PVC Hose Pipe	320.00

Vacuum Pump - Oil Free

- Prevent the need of lubricant or regular oil changes
- Enhancing pump life with filter cartridge air inlet to filter Vacuum regulator to adjust pump vacuum.
- Auto shut off when overheated



Ordering Information

Model	BORO - 017
Max. Vacuum	100 mbar
Max. flow rate	17 L / min
Motor rotation	1450 rpm
Port thread	9 mm
Noise level	50 dB
Weight	4.4 kg
Dimension (W x D X H)	(272 x 142 x 165) mm
Electrical Requirement	0.3 A
Power Consumption	60 W
HSN Code	84798200
Ordering Information	100VP300017
Price ₹	24,000.00

Caution :

Please do not use this vacuum pump with any corrosive chemicals such as Acid, Alkali & Organic Air. Avoid any material or liquid sucked down into the pump that will cause serious damage.

TUBE ROLLER

TR - 4 / TR - 6

- Tube rollers are offered to meet the budgets and applications of all labs. Rollers can be easily mounted or removed without any tools.
- Rollers can also be adjusted to accommodate tubes of different diameters.



TR - 4

Specification	TR - 4	TR - 6
Number of tubes (in ml)	9 x 5	15 X 7
Motion	Rocking & Rolling	Rocking & Rolling
Motor	AC	BLDC
Speed	Fixed	Variable
rpm	30	10 to 80
Timer	NA	Yes
Pulse mode	NA	Yes
Protection Class	IP 21	IP 21
Dimension (W x D x H) mm	(475 x 210 x 80)	(502 x 301 x 92.5)
Product Code	100R0000415000	100R0000620000
Price / Unit	16,500.00	On request

TUBE DISC ROTATORS

SDR 16

- The SDR 16 is functional tube rotator which is robust and compact. The fixed speed of 30 rpm and the gentle circular motion generated is ideal for effective mixing in blood collection tubes.



Specification	SDR 16
Tube Capacity	16x10ml or Blood tube
Speed	Fixed
rpm	30
Time in min	Infinite
Motor	AC
Protection Class	IP 21
Pulse mode	NO
Dimension	(278 x 183 x 252)
Cat Code	100CTR0160030R
Price / Unit	17,000.00

* Available till stock last.

LABQUEST BY BOROSIL®

SMART • RUGGED • PRACTICAL

- High precision Micro-pipette
- Unique, flexible volume selection mechanism
- Universally compatible tip cone
- All metal mechanism
- Bottle Top Dispensers with re-circulation



C1 THE HIGH PRECISION MICROPIPETTE FULLY AUTOCLAVABLE

- Silicone o-ring for optimal tip seal
- Robust design includes metal tip base
- Low operating thumb force



Knob



'O' ring



Ejector



C1 SINGLE CHANNEL FIXED VOL PIPETTE, Calibration & Accuracy As Per ISO 8655

Product Code	Volume Range (µl)	Inaccuracy (%)	Imprecision (%)	Price / Piece ₹
LHC17111001	1	2.5	1.8	13,600.00
LHC17111002	2	2.5	1.8	13,600.00
LHC17111005	5	1.2	0.8	13,600.00
LHC17111006	10	1	0.5	13,600.00
LHC17111008	20	1	0.3	13,600.00
LHC17111009	25	0.8	0.35	13,600.00
LHC17111010	30	1.16	0.4	13,600.00
LHC17111012	50	1	0.3	13,600.00
LHC17111016	100	0.7	0.2	13,600.00
LHC17111020	200	0.6	0.2	13,600.00
LHC17111021	250	2	0.6	13,600.00
LHC17111024	500	0.8	0.15	13,600.00
LHC17111029	1000	0.8	0.2	13,600.00
LHC17111030	2000	1.2	0.3	13,600.00
LHC17111033	5000	0.6	0.15	13,600.00
LHC17111038	10000	0.6	0.15	13,600.00

C1 Single Channel Variable Vol Pipette

Calibration & Accuracy As Per ISO 8655

Product Code	Volume Range (µl)	Volume Increment (µl)	Inaccuracy (%)	Imprecision (%)	Price / Piece ₹
LHC17112002	0.2-2	0.02	2.0	1.00	16,800.00
LHC17112005	0.5-10	0.1	1.0	0.50	16,800.00
LHC17112008	2-20	0.2	1.00	0.30	16,800.00
LHC17112016	5-50	0.5	1.00	0.30	16,800.00
LHC17112020	10-100	1	0.70	0.20	16,800.00
LHC17112024	20-200	2	0.60	0.20	16,800.00
LHC17112029	100-1000	10	0.80	0.20	16,800.00
LHC17112033	1000-5000	50	0.60	0.15	16,800.00
LHC17112038	1000-10000	20	0.60	0.15	16,800.00

Convert fixed volume pipette to a variable volume pipette

C1 Micropipettes come with detachable pre calibrated volume knobs. Cut costs while increasing the accuracy of your experiments.

Product	Description	Qty / Pk	Price / Piece ₹
On Request	C1 Fixed Vol Knob	1	2400.00
On Request	C1 Variable Vol Knob	1	3500.00

C1 THE HIGH PRECISION MICROPIPETTE FULLY AUTOCLAVABLE



C1 PIPETTE, 8 CHANNEL

Calibration & Accuracy As Per ISO 8655

Product Code	Volume Range (µl)	Volume Increment (µl)	Inaccuracy (%)	Imprecision (%)	Price / Piece ₹
LHC17113001	0.5-10	0.1	2.00	1.00	30,500.00
LHC17113002	2-20	0.2	2.00	1.00	30,500.00
LHC17113009	5-50	0.5	1.40	0.60	30,500.00
LHC17113016	10-100	1	1.30	0.50	30,500.00
LHC17113020	20-200	2	1.20	0.40	30,500.00
LHC17113022	30-300*	2	1.40	0.30z	30,500.00

* 30-300µl available in two knobs : 30 - 200 µl & 125 - 300 µl



C1 PIPETTE 12 CHANNEL

Calibration & Accuracy As Per ISO 8655

Product Code	Volume Range (µl)	Volume Increment (µl)	Inaccuracy (%)	Imprecision (%)	Price / Piece ₹
LHC17114001	0.5-10	0.1	2.00	1.00	33,900.00
LHC17114002	2-20	0.2	2.00	1.00	33,900.00
LHC17114009	5-50	0.5	1.40	0.60	33,900.00
LHC17114016	10-100	1	1.30	0.50	33,900.00
LHC17114020	20-200	2	1.20	0.40	33,900.00
LHC17114022	30-300*	2	1.40	0.30	33,900.00

* 30-300µl available in two knobs : 30 - 200 µl & 125 - 300 µl

C3 THE ECO MICROPIPETTE RANGE FULLY AUTOCLAVABLE



C3 Single Channel Fixed Vol Pipette , Calibration & Accuracy As Per ISO 8655

Product Code	Volume Range (µl)	Inaccuracy (%)	Imprecision (%)	Price / Piece ₹
LHC37111001	1	2.5	1.8	3,500.00
LHC37111002	2	2.5	1.2	3,500.00
LHC37111005	5	1.2	0.8	3,500.00
LHC37111006	10	1	0.5	3,500.00
LHC37111008	20	1	0.3	3,500.00
LHC37111009	25	0.8	0.35	3,500.00
LHC37111010	30	1.16	0.4	3,500.00
LHC37111012	50	1	0.3	3,500.00
LHC37111016	100	0.7	0.2	3,500.00
LHC37111020	200	0.6	0.2	3,500.00
LHC37111021	250	0.4	0.2	3,500.00
LHC37111024	500	0.8	0.15	3,500.00
LHC37111029	1000	0.8	0.2	3,500.00
LHC37111033	5000	0.6	0.15	3,500.00
LHC37111038	10000	0.6	0.15	3,500.00



Precision Click



Easy to read dial



Soft Plunger Light weight

C3 Single Channel Variable Vol Pipette, Calibration & Accuracy As Per ISO 8655

Product Code	Volume Range (µl)	Volume Increment (µl)	Inaccuracy (%)	Imprecision (%)	Price / Piece ₹
LHC37112002	0.2-2	0.01	2.00	1.00	4,900.00
LHC37112005	0.5-10	0.1	1.00	0.50	4,900.00
LHC37112008	2-20	0.1	1.00	0.30	4,900.00
LHC37112016	5-50	0.5	1.00	0.30	4,900.00
LHC37112020	10-100	0.5	0.70	0.20	4,900.00
LHC37112024	20-200	1	0.60	0.20	4,900.00
LHC37112029	100-1000	5	0.80	0.20	4,900.00
LHC37112033	500-5000	50	0.60	0.15	4,900.00
LHC37112038	1000-10000	100	0.60	0.15	4,900.00

C1 ELECTRONIC MICROPIPETTE

ELECTRONIC PIPETTE SINGLE CHANNEL

Calibration and Accuracy As per ISO 8655

Product Code	Volume Increment (µl)	Volume Range (µl)	Test Volume (µl)	Inaccuracy (%)	Imprecision (%)	Price / Piece ₹
LHC17022042	0.5-10	0.01	1	2.5	1.8	34,200.00
			5	2	1	
			10	1	0.6	
LHC17022012	5-100	0.1	10	3	1	34,200.00
			50	1	0.5	
			100	0.8	0.2	
LHC17022008	10-200	0.1	20	2.5	1	34,200.00
			100	0.7	0.5	
			200	0.6	0.2	
LHC17022024	50 - 1000	1	100	3	0.6	34,200.00
			500	1	0.4	
			1000	0.6	0.2	
LHC17022016	250 - 5000	5	500	2.4	0.6	34,200.00
			2500	1.7	0.25	
			5000	0.6	0.15	



CE ELECTRONIC PIPETTE 8 CHANNEL,

Calibration and Accuracy As per ISO 8655

Product Code	Volume Range (µl)	Volume Increment (µl)	Price / Piece ₹
LHC17023001	0.5-10	0.01	55,600.00
LHC17023002	2-20	0.01	55,600.00
LHC17023016	5-100	0.1	55,600.00
LHC17023020	10-200	0.1	55,600.00
LHC17023022	15-300	0.1	55,600.00



CE ELECTRONIC PIPETTE 12 CHANNEL,

Calibration and Accuracy As per ISO 8655

Product Code	Volume Range (µl)	Volume Increment (µl)	Price / Piece ₹
LHC17024001	0.5-10	0.01	62,800.00
LHC17024002	2-20	0.01	62,800.00
LHC17024016	5-100	0.1	62,800.00
LHC17024020	10-200	0.1	62,800.00
LHC17024022	15-300	0.1	62,800.00



FAST PIPETTE

Pipette Controller

C1 Pipette filling device

Product Code	Description	Price / Piece ₹
LHC17005011	Pipette filling device	17,000.00



BOTTLE TOP DISPENSER



2011 - Bottle Top Dispensers Research Model - Fully Autoclavable, Calibration And Accuracy As Per ISO 8655

Product Code	Vol. Range (ml)	Increment (ml)	Accuracy		CV		Price / Piece ₹
			± %	± ml	± %	± ml	
LH002011002	0.25 - 2.5	0.05	0.6	0.012	0.2	0.004	12,500.00
LH002011005	0.5 - 5.0	0.1	0.6	0.03	0.2	0.01	12,500.00
LH002011016	1.0 - 10.0	0.2	0.6	0.06	0.2	0.02	12,500.00
LH002011020	2.5 - 30.0	0.5	0.6	0.18	0.2	0.06	18,200.00
LH002011040	5.0 - 60.0	1	0.6	0.36	0.2	0.12	18,200.00
LH002011100	10.0 - 100.0	2	0.5	0.5	0.1	0.1	21,700.00

Dispensers come with 20mm, 32mm, 36mm, 40mm & 45mm bottle neck adapters.



2012 - Bottle Top Dispensers Pinnacle Model - with Re-circulation Valve, Calibration And Accuracy As Per ISO 8655

Product Code	Vol. Range (ml)	Increment (ml)	Accuracy		CV		Price / Piece ₹
			± %	± ml	± %	± ml	
LH002012002	0.25 - 2.5	0.05	0.6	0.015	0.2	0.005	20,800.00
LH002012005	0.5 - 5.0	0.1	0.5	0.025	0.1	0.005	20,800.00
LH002012016	1.0 - 10.0	0.2	0.5	0.05	0.1	0.01	20,800.00
LH002012020	2.5 - 30.0	0.5	0.5	0.15	0.1	0.03	29,200.00
LH002012040	5.0 - 60.0	1	0.5	0.3	0.1	0.06	31,100.00
Lh002012100	10.0 - 100.0	2	0.5	0.5	0.1	0.1	44,900.00

Dispensers come with 20mm, 32mm, 36mm, 40mm & 45mm bottle neck adapters.



2013 - Bottle Top Dispenser Ultimius - With Dual Valve Technology Calibration and Accuracy As Per ISO 8655

Product Code	Capacity	Price / Piece ₹
LH002013002	0.25 - 2.5	31,000.00
LH002013005	0.5 - 5.0	31,000.00
LH002013016	1.0 - 10.0	31,000.00
LH002013020	2.5 - 30.0	41,500.00
LH002013040	5.0 - 60.0	41,500.00
LH002013100	10.0 - 100.0	57,000.00

Dispensers come with 28mm, 30mm, 32mm, 36mm, 40mm & 45mm bottle neck adapters.

DIGITAL BURETTE



Model No.	Capacity (ml)	Increment	Accuracy		CV		Price / Piece
			± %	± ml	± %	± ml	
LH002014006	10	0.005 ml	0.2	0.02	0.07	0.007	79,200.00
LH002014009	25	0.01 ml	0.2	0.05	0.07	0.0175	79,200.00
LH002014012	50	0.01 ml	0.2	0.1	0.07	0.035	79,200.00

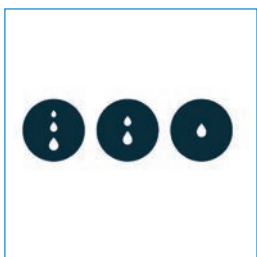

Work Accurately with 3 Calibrated Pre-set Speeds

Digital Burette can be flexibly operated at 3 Calibrated Pre-set Speeds, including dropwise dispensing, to achieve accurate end points.



Operate Smoothly with Motor Control

Motor controlled piston movement facilitates correct and comfortable titrations. It eliminates the errors associated with manual wheel controlled piston movement.



Re-direct Reagents with Recirculation Mode

Recirculation Mode prevents the loss of reagents during purging by redirecting them into the mounted bottle and facilitates bubble-free dispensing.



Dispense Easily with

Borosil Digital Burette is an adjustable delivery nozzle. It offers a high degree of flexibility in both the horizontal and vertical directions, facilitating easy dispensing in demanding laboratory conditions.



Perform Quick Titrations with TFT Touchscreen

A user-friendly TFT Touchscreen guides quick and displays numeric data up to the second decimal. Keep the Stylus pressed against it to perform dispensing and lift it to stop at once.



Enhanced Functionality with a Robust Control Panel

The instrument comes with a powerful Control Panel. Use it to perform functions like automatically refill without changing the reading, perform a zero reset (via Tare), switch the instrument off, etc.

Premium Micro Pipette Tips

- Certified DNase, RNase and Pyrogen Free
- Free of PCR inhibitors, lubricants and heavy metals
- Produced from special diamond polish mould using medical grade virgin polypropylene which provides very high transparency
- With graduations for visual control of liquid transfer
- Available in both standard as well as low retention
- With no secondary treatment and with no silicone additives for low retention
- With special PE filters for prevention of aerosols and contamination
- Specifically configured to fit major Pipette Brands available worldwide

Filter tip features can be selected as per permutation of

- Sterile
- Non sterile
- Low retention
- Filter

FILTER TIPS

BOROSIL filter tips are manufactured using specifically developed Polyethylene filters to block aerosols from entering into the pipette.

This helps in prevention of cross contamination.

Ideal for use in applications like sequencing, DNA amplification, Tissue culture, RT-PCR and other critical protocols.

LOW RETENTION TIPS

BOROSIL low retention tips are manufactured from a specific resin in combination with high quality diamond finish moulds to give super hydrophobic internal surface. This results in tips having minimum retention with maximum accuracy.

Further since no silicone treatment is given, there is absolutely no leaching effect.



UNIVERSAL GRADUATED TIPS

Universal Graduated Tips Bulk Pack

Product Code	Short Code	Tip Vol μ l	Special Feature	Selling Unit	Price / Piece ₹
BGT0000010B	BGT-10B	10	–	1000 tips/ pack	530.00
BGT0000200B	BGT-200B	200	–	1000 tips/ pack	490.00
BGT000200BC	BGT-200BC	200	Yellow	1000 tips/ pack	490.00
BGT0001000B	BGT-1000B	1000	–	1000 tips/ pack	740.00
BGT001000BC	BGT-1000BC	1000	Blue	1000 tips/ pack	740.00
BGT0C10005000B	BGT-C10005	5000	Only C1	100 tips/ pack	1,200.00
BGT0C30005000B	BGT-C30005	5000	Only C3	100 tips/ pack	1,200.00
BGT0C10010000B	BGT-C10010	10000	Only C1	100 tips/ pack	2,620.00
BGT0C30010000B	BGT-C30010	10000	Only C3	100 tips/ pack	2,620.00

Universal Graduated Tip Racks

Product Code	Short Code	Tip Vol μ l	Special Feature	Selling Unit	Price / Piece ₹
BGT0000010R	BGT-10R10	10	–	10 X 96 Tips/rack	2,240.00
BGT0000200R	BGT-200R	200	–	10 X 96 Tips/rack	2,120.00
BGT0001000R	BGT-1000R	1000	–	6 X 96 Tips/ rack	1,360.00

Universal Graduated Tip Racks Sterile

Product Code	Short Code	Tip Vol μ l	Special Feature	Selling Unit	Price / Piece ₹
BGT000010SR	BGT-10SR10	10	–	10 X 96 Tips/rack	2,410.00
BGT000200SR	BGT-200SR	200	–	10 X 96 Tips/rack	2,290.00
BGT001000SR	BGT-1000SR	1000	–	6 X 96 Tips/ rack	1,590.00

Universal Graduated Tip Racks Sterile Low Retention

Product Code	Short Code	Tip Vol μ l	Special Feature	Selling Unit	Price / Piece ₹
BGT00010SLR	BGT-10SLR	10	–	10 X 96 Tips/rack	2,580.00
BGT00200SLR	BGT-200SLR	200	–	10 X 96 Tips/rack	2,520.00
BGT01000SLR	BGT-1000SLR	1000	–	6 X 96 Tips/ rack	2,050.00

Universal Graduated Tip Reload Stack Sterile

Product Code	Short Code	Tip Vol μ l	Special Feature	Selling Unit	Price / Piece ₹
BGT000010SZ	BGT-10SZ	10	–	10 X 96 tips / rack	1,650.00
BGT000200SZ	BGT-200SZ	200	–	10 X 96 tips / rack	1,580.00
BGT001000SZ	BGT-1000SZ	1000	–	5 x 96 tips/ rack	1,180.00

Universal Graduated Tip Reload Stack Sterile Low Retention

Product Code	Short Code	Tip Vol μ l	Special Feature	Selling Unit	Price / Piece ₹
BGT00010SLZ	BGT-10SLZ	10	–	10 X 96 tips / rack	1,940.00
BGT00200SLZ	BGT-200SLZ	200	–	10 X 96 tips / rack	1,880.00
BGT01000SLZ	BGT-1000SLZ	1000	–	5 x 96 tips/ rack	1,470.00

UNIVERSAL GRADUATED FILTER TIPS

Universal Graduated Filter Tips Bulk Pack

Product Code	Short Code	Tip Vol μ l	Special Feature	Selling Unit	Price / Piece ₹
BGT000010FB	BGT-10FB	10	–	1000 tips/ pack	2,460.00
BGT000020FB	BGT-20FB	20	–	1000 tips/ pack	2,460.00
BGT000050FB	BGT-50FB	50	–	1000 tips/ pack	2,460.00
BGT000100FB	BGT-100FB	100	–	1000 tips/ pack	2,460.00
BGT000200FB	BGT-200FB	200	–	1000 tips/ pack	2,460.00
BGT001000FB	BGT-1000FB	1000	–	1000 tips/ pack	3,050.00

Universal Graduated Filter Tip Racks

Product Code	Short Code	Tip Vol μ l	Special Feature	Selling Unit	Price / Piece ₹
BGT000010FR	BGT-10FR	10	–	10 X 96 Tips/rack	3,520.00
BGT000020FR	BGT-20FR	20	–	10 X 96 Tips/rack	3,520.00
BGT000050FR	BGT-50FR	50	–	10 X 96 Tips/rack	3,520.00
BGT000100FR	BGT-100FR	100	–	10 X 96 Tips/rack	3,520.00
BGT000200FR	BGT-200FR	200	–	10 X 96 Tips/rack	3,520.00
BGT001000FR	BGT-1000FR	1000	–	6 X 96 Tips/ rack	2,460.00

Universal Graduated Filter Tip Rack Sterile

Product Code	Short Code	Tip Vol μ l	Special Feature	Selling Unit	Price / Piece ₹
BGT00010SFR	BGT-10SFR10	10	–	10 X 96 Tips/rack	3,640.00
BGT00020SFR	BGT-20SFR	20	–	10 X 96 Tips/rack	3,640.00
BGT00050SFR	BGT-50SFR	50	–	10 X 96 Tips/rack	3,640.00
BGT00100SFR	BGT-100SFR	100	–	10 X 96 Tips/rack	3,640.00
BGT00200SFR	BGT-200SFR	200	–	10 X 96 Tips/rack	3,640.00
BGT01000SFR	BGT-1000SFR	1000	–	6 X 96 Tips/ rack	2,700.00

Universal Graduated Filter Tip Rack Sterile Low Retention

Product Code	Short Code	Tip Vol μ l	Special Feature	Selling Unit	Price / Piece ₹
BGT0010SLFR	BGT-10SLFR	10	–	10 X 96 Tips/rack	4,460.00
BGT0020SLFR	BGT-20SLFR	20	–	10 X 96 Tips/rack	4,460.00
BGT0050SLFR	BGT-50SLFR	50	–	10 X 96 Tips/rack	4,460.00
BGT0100SLFR	BGT-100SLFR	100	–	10 X 96 Tips/rack	4,460.00
BGT0200SLFR	BGT-200SLFR	200	–	10 X 96 Tips/rack	4,460.00
BGT1000SLFR	BGT-1000SLFR	1000	–	6 X 96 Tips/ rack	3,340.00

UNIVERSAL GRADUATED INDIVIDUALLY WRAPPED TIPS

Universal Graduated Tips Sterile Individually Wrapped

Product Code	Short Code	Tip Vol μ l	Special Feature	Selling Unit	Price / Piece ₹
BGT000200SW	BGT-2000SW	200	–	400 Tips/ pack	2,570.00
BGT001000SW	BGT-1000SW	1000	–	200 tips/ pack	1,720.00

Universal Graduated Tips Sterile Low Retention Individually Wrapped

Product Code	Short Code	Tip Vol μ l	Special Feature	Selling Unit	Price / Piece ₹
BGT00200SLW	BGT-2000SLW	200	–	400 tips/ pack	2,700.00
BGT01000SLW	BGT-1000SLW	1000	–	200 tips/ pack	1,880.00

EMPTY TIP BOX RACKS

Product Code	Short Code	Tip Vol μ l	Special Feature	Selling Unit	Price / Piece ₹
BGT00010ETR	BGT-10ETR	10	–	10 Rack Boxes	1,740.00
BGT00200ETR	BGT-200ETR	200	–	10 Rack Boxes	1,740.00
BGT01000ETR	BGT-1000ETR	1000	–	6 Rack Boxes	1,160.00

Lab Services Complete Solutions



IQ/OQ Services

LabQuest Services offers various Qualifications programmes which assist instrument owners with their validation process. Installation Qualification (IQ) of full system setup includes comprehensive documentation as per standard guidelines. Operational Qualification (OQ), package includes an OQ document, test methods, carefully selected standards and accompanying certificate.



Installation & Calibration Services

To ensure that your equipment delivers accurate and precise results it needs to be calibrated at regular intervals by trained professionals.



AMC & CMC Services

Keep your lab running smoothly with comprehensive service coverage plans from LabQuest service. Discover how LabQuest service plans fit your lab's needs.

To know more contact us lab.support@borosil.com

TECHNICAL INFORMATION

BOROSIL LOW EXPANSION BOROSILICATE GLASS:

From the 16th century to the present day, chemical research teams have been using glass containers for a very simple reason. As the glass container is transparent, the contents and the reaction are clearly visible. However, since chemists need to heat, cool and mix chemical substances, ordinary glass is not always appropriate for laboratory work.

Laboratory work requires apparatus made of glass that can readily be moulded into any desired shape or form. It requires glass that offers maximum inertness when in contact with the widest range of chemical substances. The glass should have the capability to withstand thermal shock without fracture, and it should facilitate high temperature work without deforming. It should be resilient enough to survive the everyday knocks to which it will be subjected in normal laboratory handling, washing and sterilising processes.

BOROSIL is the trade name of such a glass.

The products represent optimum mechanical, thermal and chemical behaviour. This glass is used in laboratories as well as for industrial applications, where thermal shock resistance, mechanical resistance as well as unusual chemical resistance are required.

CHEMICAL COMPOSITION OF GLASS

Borosil glass is a 3.3 Type I low alkali borosilicate glass. It is virtually free from the Magnesia-Lime-Zinc group, and is also completely free of arsenic and other heavy metals. Its **typical chemical composition** is given below.

Content	Approx % by weight
SiO ₂	81
B ₂ O ₃	13
Na ₂ O / K ₂ O	4
Al ₂ O ₃	2

THERMAL PROPERTIES

Borosil glass has a low co-efficient of thermal expansion. Consequently, the thermal stresses under a given temperature gradient are also low. The glass can withstand

higher temperature gradients and also sudden temperature changes / thermal shocks. Minute scratching of the glass surface can, however, reduce its thermal resistance.

'Strain Point' should be regarded as the maximum safe operating temperature for Borosil glassware. When heated above 500°C, the glass may acquire permanent stresses on cooling.

All Borosil laboratoryware is annealed in a modern Lehr, under strictly controlled conditions to ensure minimal residual stresses in the products.

The **typical thermal properties** of Borosil glassware are mentioned below

Coefficient of Linear Expansion	2.5 x10 ⁻⁷ cm / cm / °C
Strain Point	515°C
Annealing Point	565°C
Softening Point	820°C
Specific Heat	0.2
Thermal Conductivity (Cal / cm ³ / °C / sec)	0.0027

CHEMICAL PROPERTIES

BOROSIL 3.3 Glass is highly resistant to water, neutral and acid solutions, concentrated acids and acid mixtures, and to chlorine, bromine, iodine and organic substances. The chemical resistance of this glass is superior to that of most metals and other materials, even when exposed to long processing periods and temperatures above 100 °C. A slight release of mainly monovalent ions takes place after exposure of the glass to water or acids. A very thin layer of impervious silica gel is subsequently formed on the surface of the glass, which in turn slows down further attack. At higher temperatures and in more concentrated forms the glass surface is subject to increased attack by hydrofluoric acid, hot phosphoric acid and alkaline solutions.

Hydrolytic Class (ISO 719)	HGB 1
Acid Class (DIN 12 116)	S1
Alkali Class (ISO 695)	A 2

A GUIDE ON GLASS BREAKAGE AND RECOMMENDED SOLUTIONS

Type of breakage	Causes of glass breakage	Solution
Breakage during heating procedures	Drying up of vessel during heating due to evaporation	Do not leave the vessel unattended during heating procedure
	Use of excessive heat throughout the experiment	Decrease the temperature as the liquid level drops
	Use of point source heating	Solution Use a large but soft flame for heating
	Heating of the vessel above the liquid level	"Ensure that the flame is in contact with the vessel below the liquid level"
	Uneven heating the vessel over electric heaters and hot plates; use of an under sized hot plate	"Always ensure that the surface of the hot plate is larger in area than the base of the vessel being heated."

A GUIDE ON GLASS BREAKAGE AND RECOMMENDED SOLUTIONS

Type of breakage	Causes of glass breakage	Solution
Breakage during cooling procedures	Placing the hot vessel on cold surface/ filling up a hot vessel with cold liquids	Allow the vessel to cool before placing or filling it up on/ with cold surfaces/substances
Breakage due to scratches and abrasions inside the vessel	Use of incorrect anti-bumping device, such as broken porcelain with sharp edges that causes internal abrasions and reduces mechanical strength of the glass	Always use anti-bumping devices in the vessel, such as powdered pumice or glass wool
	Use of improper stirring device that causes internal abrasions and reduces mechanical strength of the glass	Always use a teflon sleeve or a similar device on stirring rods, to prevent scratching of the inside of the vessel
		When using a glass vessel with a magnetic stirrer, always use a covered follower. This prevents abrasion of the walls from inside of the vessel
Breakage of the base of the glass container	Placing the hot vessel on cold surface/ filling up a hot vessel with cold liquids	Allow the vessel to cool before placing or filling it up on/ with cold surfaces/substances
	Use of a glass or metal mechanical stirrer in a glass vessel	Always pre-determine the height of the stirrer before use, to ensure that the stirrer blade does not come in contact with the base or sides of the vessel
	Addition of the antibumping device from a height in the glass vessel	
	Addition of water to acid in a glass vessel which generates sudden heat and leads to breakage	Always ensure to add water first in the glass container followed by slow addition of acid
Breakage due to vacuum/ pressure	Application of sudden pressure changes	Apply and release positive or negative pressures gradually.
	Use of pressure beyond the limit	Refer manufacturers instructions carefully before applying pressure/ vacuum to the glass vessel
Breakage of stopcocks and joints	Stopcocks stuck hardly on burettes and funnels	When not in use insert a thin strip of paper between the joint surfaces to prevent them from sticking
		Mechanical separation of the joint by carefully rocking the Cone in the socket, or gentle tapping the socket flange on a wooden surface, or by heating the socket and not the Cone in a localised flame
		Use of penetrating oil
		Frequent lubrication to prevent the stopcock and joints from sticking
		When using lubricants, it is advisable to apply a light coat of grease all around the upper part of the joint. Use only a small amount, and avoid greasing the part of the joint that comes in contact with the inside of the apparatus. Three types of lubricants are commonly used on standard taper joints. (a) Hydrocarbon grease is the most widely used. It can be removed easily by most laboratory solvents, including acetone. (b) As hydrocarbon grease is easy to remove, silicon grease is usually preferred for higher temperature or high vacuum applications. It can be removed with chloroform easily. (c) For long-term reflux or extraction reactions, a water-soluble, organic and insoluble grease such as glycerin, is suitable. Glycerin can be removed by means of water
Breakage during inserting glass tubing into rubber bung	Improper lubrication	Use water, oil or glycerol on both, the tubing as well as the rubber bung
	Presence of rough ends	Always fire-polish the rough ends of the glass tubing before attempting to insert it into flexible tubing

CLEANING OF GLASSWARE

Use of clean glassware is crucial for efficacy and efficiency of chemical reactions or biological processes. It is the key to success of any experiment. Use of dirty glass ware can lead to cross contamination of chemicals thereby leading to erroneous results. Cleaning of glassware should be an integral part of the good laboratory practices and should be followed by each member of the lab after each use.

DID YOU KNOW ?

New glassware is slightly alkaline in reaction. Hence, it should be soaked for about 2 to 3 hours in acidic water (1% solution of hydrochloric acid or nitric acid). Rinse with water and then soak the empty glassware in a basin / tub containing suitable cleaning agent / solution for 20 to 30 minutes.



Cleaning agents :

- Water/Purified water/warm water – Routine cleaning of all glassware
- Soaps/ detergent solution - Routine cleaning of all glassware
- Cleaning powders with/without abrasives – For exceptionally dirty glassware
- Acetone/Solvents - Glassware with greasy, sticky, waxy materials and glassware containing water immiscible solvents
- Hot nitric acid – glassware containing cloudy precipitates and coagulated organic matter, glassware required for TOC analysis

NOTE : After use of any of the cleaning agents, other than water, glassware should be rinsed and cleaned with water as per the standard laboratory procedure

DO'S AND DON'TS OF CLEANING

DO'S	DON'T'S
Remove the content of glassware before washing	Do not use a metallic scrubber or a brush with metallic bristles for cleaning
Remove all markings / sticker labels from the glassware.	Do not use strong alkalis for cleaning
Bring glassware to ambient temperature before cleaning, if they are subjected to heating or cooling during analysis	Do not use chromic acid and sulphuric acid mixture for cleaning as it is hazardous and toxic in nature
Use a suitable cleaning agent depending upon the type of dirt	
Soak the glassware in the cleaning agent for about half an hour before cleaning	
Use a good quality brush for cleaning	
After applying the cleaning agents always rinse the glassware first with tap water and finally with purified water	
Recommended temperature for drying of glassware is 60°C - 100°C	

Pipette Cleaning

- Dip the pipettes with their tips down, in a cylinder or tall jar of water, immediately after use.
- Do not drop them into the jar as this may break or chip the tips and render them useless.
- A pad of cotton or glass wool at the base of the jar will help to prevent breaking of the tips.
- Please ensure that the water level is high enough to immerse the greater portion of all or each of the Pipettes.
- Then drain the Pipettes and transfer them into a cylinder or jar containing any suitable cleaning agent or any suitable detergent solution.
- Allow it to soak in a jar or cylinder for about half an hour.
- Drain the pipette and run tap water over and through them until all contents are removed.
- Soak the Pipettes in purified water for at least one hour.
- Remove them and dry the external surface with a cloth, shake out the water and dry in oven.
- After drying, place the Pipettes in a dust-free drawer.
- For sterile applications, wrap serological and bacteriological Pipettes in an autoclavable bag and autoclave at 121°C for 30 mins or place them in
- Pipette cans and sterilise them in the dry air steriliser at 160°C for two hours.
- A Pipette used for transferring infectious material should have a plug of cotton placed in its mouth end before sterilising

Burette Cleaning

- Remove stopcock key before cleaning and wash the stopcock key separately
- Wash the burette with suitable cleaning agent or any other suitable detergent solution
- Rinse with tap water until all the dirt is removed. Then rinse with purified water.
- Keep the cleaned burette in inverted position until dry.
- Open the stopcock and keep for drying.
- Before the stopcock key is replaced in the burette, lubricate the joint with a small amount of lubricant.
- Always cover tip of burettes with butter paper or aluminium foil, when not in use.

Note: **The burette stopcock keys and glass stopcocks are not interchangeable**, hence, glass key and burette bore should be marked properly to avoid mix-ups

Culture Tubes

- Culture tubes which have been used previously must be sterilized before cleaning. The best general method for sterilising culture tubes is by autoclaving for 30 minutes at 121°C (15 lb pressure). Media which solidify on cooling should be poured out while the tubes are hot.
- After the tubes are emptied, brush them with a suitable cleaning agent.
- Rinse thoroughly with tap water, rinse with purified water, shake out the water and dry in oven.
- After cleaning before the next use, the culture tubes need to be sterilized again.
- The culture tubes and culture medium can be sterilized together in one cycle or can be sterilized separately.
- In the latter case, the sterile medium can be filled in the sterile culture tubes aseptically.

Serological Tubes

- Serological Tubes should be chemically clean but need not be sterile. However, specimens of blood which are to be kept for some time at room temperature should be collected in a sterile container. It may be expedient to sterilize all tubes as routine.
- To clean and sterilize tubes containing blood, discard the clots in a waste container and place the tubes in a large basket.
- Put the basket with others, in a large bucket or boiler. Cover with water, add a fair quantity of soft soap or suitable cleaning agent and boil for 30 minutes. Rinse the tubes and clean with brush, rinse and dry with the usual precautions.

Note: It is imperative when washing serological glassware that all acid, alkali and detergent be completely removed. Both acid and alkali in small amounts destroy complement and in larger amounts produce haemolysis. Detergents interfere with serologic reactions.

Serological tubes and glassware should be kept separate from all other glassware and used for nothing except serologic procedures.

Microscope Slides

Cleaning of New slides

- Put a drop of cleaning solution of the slide. This can be a detergent solution or diluted alcohol solution
- Apply the cleaning solution uniformly on both the sides of slide and clean the surface carefully with your fingers or using a lint-free microfibre towel
- Rinse thoroughly under running tap water until the cleaning solution is completely washed out
- Ideally a thoroughly cleaned slide should hold a layer of water uniformly over its surface. This indicates that the slide is cleaned properly. If the water layer is formed over the surface in blotches, repeat the cleaning
- After cleaning is done dry slide using a paper towel/ microfibre towel.
- Allow the slides to air dry for some time before using

Cleaning Used slides

- Place the used slide in a container full of warm water and detergent
- Leave the slide in this for at least 0-8 hours
- Clean the slide using a gauze by rubbing both the sides until they are free of the dirt, stains, oil, etc.
- Rinse thoroughly under running tap water until the cleaning solution is completely washed out
- Ideally a thoroughly cleaned slide should hold a layer of water uniformly over its surface. This indicates that the slide is cleaned properly. If the water layer is formed over the surface in blotches, repeat the cleaning
- After cleaning is done dry slide using a paper towel/ microfibre towel
- Allow the slides to air dry for some time before using

Recalibration of volumetric glassware

Abstract: ASTM Standard E 452-01, Clause 4.2

3.3 low expansion borosilicate volumetric glassware will hold its calibration indefinitely provided that it is not exposed to hydrofluoric acid, phosphoric acid, or strong, hot alkalis, and that it is not heated above 150°C when dry. A frosting of the glass surface (when viewed dry) indicates that chemical attack has occurred and recalibration may be in order. As a precaution, however, it is recommended that the glassware be recalibrated after 10 years of service regardless of its appearance.

AUTOCLAVING OF GLASSWARE

Autoclaves are widely used to sterilise instruments, glassware and plasticware, solutions and media, and to decontaminate biological wastes. Due to the physical hazards (e.g. heat, steam and pressure) associated with autoclaving, extra care must be taken to use them safely. Each autoclave has unique characteristics and operating requirements. Please review and understand the owner's manual before using any autoclave for the first time, and every time thereafter. Also, please follow all the safety regulations for autoclaving, laid down by your institution.

Autoclaving empty glassware

1. Place individual glassware vessels within a heat resistant plastic or metal tray on a shelf or rack.
2. Never place them directly on the autoclave base or floor
3. Always maintain space (>5 cm) between glass vessels to give them room to expand while heating, and to prevent them from hitting other vessels when entering or leaving the autoclave
4. Add water rising up to 1/4 to 1/2 inch in the tray, so that the glassware will heat more evenly
5. Large heavy glassware, such as 3L or larger spinner flasks 5L or larger bottles and carboys should have a small amount of distilled water placed inside them to help generate steam when they are being sterilised dry in an autoclave

Autoclaving glassware containing liquids

Never autoclave items containing corrosives (e.g. acids, bases, phenol), solvents or volatiles (e.g. ethanol, methanol, chloroform) or radioactive materials.

1. Fill the glassware only half full with the liquids to be sterilised.
2. Take into consideration, the volume of liquid to be autoclaved.
For e.g. : 2-litre flask containing 1 litre of liquid takes much longer to sterilise than four 500 ml flasks, each containing 250 ml of liquid
3. Do a test run when autoclaving larger volumes of liquid, to make sure that the liquid has reached 121°C
4. Always use the slow exhaust or liquid cool cycle when autoclaving liquids, to prevent the liquid from boiling over, causing loss of the contents
5. Suspend an autoclave thermometer with a thin wire, in the middle of the liquid-filled container to record the highest temperature reached. Then, check its reading after the autoclave run is complete. If the temperature is too low, then the run-time will need to be increased or the volume will need to be reduce
6. To prevent bottles from getting shattered during pressurisation, the caps of the vessels with liquids must be loosened completely before loading

Safety during Autoclaving

Always follow the safety precautions to protect yourself and the equipment being used.



1. Be sure to wear the correct PPE including a lab coat, eye protection, closed-toe shoes, and heat-resistant gloves
2. Remember that after usage, glassware will be hot and can cause serious injury if the correct precautionary measures aren't taken
3. Always wait for the pressure gauge to drop to zero with zero time remaining before you open the door
4. Stand behind the door as you open it and allow all the steam to fully escape before reaching into the autoclave
5. Let glassware fully cool before touching them

DO'S	DON'T'S
Wait for 5 minutes before removing dry glassware from the autoclave, and wait for 10 to 20 minutes before removing glassware containing liquids	Do not tighten caps on the vessels immediately after autoclaving The cap or the vessel may get shattered due to the vacuum resulting from the cooling of the steam in the vessel
For non-liquid loads, please allow the glassware to cool for 15 minutes before touching it For liquid loads, please allow the liquid to stand for a full hour before touching the glassware	Do not put hot glassware, especially large bottles, from an autoclave (or any other heat source) on to a cold bench top. The stress that is induced will often cause the base of the vessel to crack or fall off, releasing its hot contents

PERSONAL SAFETY

- Use tongs or asbestos gloves to remove any glassware from heat. Hot glass can cause severe burns.
- Protective gloves, safety shoes, aprons and goggles should be worn to safeguard against chemical accidents, spilling or splattering.
- Always flush the outside of the acid bottle with water before opening it. Do not place the stopper on the counter top, where someone else may come in contact with acid residue.
- Care should be taken when handling mercury. Even a miniscule amount of mercury in the base of a drawer can poison the atmosphere in an entire room. Mercury toxicity is cumulative and the element's ability to amalgamate with a number of metals is well known. Following any accident involving mercury, the area should be checked thoroughly to ensure that there are no globules remaining. All mercury containers should be kept well stoppered.
- Never drink from a beaker. A beaker intended specifically for the use of drinking is a hazard in the laboratory. Do not taste chemicals to identify them. Smell chemicals only when necessary, and only by wafting a small amount of vapour towards the nose.
- Avoid using a Pipette with the mouth, particularly when using concentrated acids, alkalis or potentially biohazardous materials. Use mechanical means, such as a rubber bulb or an automatic dispenser.
- Do not fill the receptacle with any material other than that mentioned on the label. Label all containers before filling. Discard the contents of any unlabelled containers.
- To prevent breakage when clamping glassware, do not permit glass-to-metal contact, and do not use excessive force to tighten the clamps.
- Do not look down into a Test Tube being heated or containing chemicals, and do not point its open end at another person. A reaction could cause the contents to be ejected suddenly, resulting in injury.
- Splattering from acids, caustic materials and strong oxidising solutions on the skin or clothing should be washed off immediately with large quantities of water.
- When working with chlorine, hydrogen sulphide, carbon monoxide, hydrogen cyanide and other highly toxic substances, always use a protective mask. Alternatively, perform these experiments under a fume hood in a well ventilated area.
- In working with volatile materials, please keep in mind that heat causes expansion and confinement of such expansion results in explosion. Also remember that this danger exists even if external heat is not applied.
- Perchloric acid is particularly dangerous as it explodes when brought in contact with organic materials. Do not use perchloric acid around wooden benches or tables.
- Keep perchloric acid bottles on glass or ceramic trays with capacity that is adequate to hold all the acid in case the bottle breaks.
- When using perchloric acid, always wear protective clothing.
- When using hot plates and other electrical equipment, always ensure that the wire and plugs are in good condition. Do not handle an electrical connection with damp hands

	Cat No.	Pg. No.		Cat No.	Pg. No.
A					
APPARATUS					
Arsenic determination apparatus As per USP	5200	74			
Arsenic determination apparatus GUTZEIT	5201	74			
Arsenic determination apparatus as per BP	5202	74			
Arsenic determination apparatus as per IP	5203	75			
Arsenic determination apparatus GUTZEIT as per IS	5204	75			
Arsenic determination apparatus as per JP	5205	75			
Arsenic determination apparatus as per EP	5206	76			
Oxygen combustion as per USP	5210	76			
Methoxy determination assembly as per USP	5211	76			
Sulphur Di-oxide assembly as per USP	5212	77			
Sodium Alginate Assembly as per USP	5215	77			
RM Value apparatus	3454	78			
Dean Stark apparatus as per IP	3602	78			
Gas generator apparatus, KIPPS	6550	142			
ADAPTERS					
Adapters, Enlarging, Connecting	8800	157			
Adapters, Reduction, Connecting	8820	157			
Adapters, Receiver Bent With Vacuum Connection	8830	157			
Adapters, Multiple With Two Necks Parallel	8831	158			
Adapters, Multiple With Two Necks - one vertical & one at 45°	8832	158			
Adapters, Multiple with three Neck, Two Parallel & one at 45°	8833	158			
Adapters, Swan Neck	8834	159			
Adapters, Cone / Rubber Tubing	8835	159			
Adapters, Cone / Flexible Tubing	8836	159			
Adapters, Receiver, Straight socket to rubber	8837	160			
Adapters, Receiver, Straight with Vacuum	8838	160			
Adapters, Receiver, Bend with vent	8839	160			
Adapter cones screw thread	8840	161			
Slopping Plane still head	8841	161			
Adapter receiver	8844	161			
Adapter receiver, Plain bent	8845	162			
Adapter recovery Bent with slopping end	8846	162			
Adapter recovery Bent vertical	8847	162			
Claisen head slopping	8849	163			
Adapter receiver plain, vertical	8850	163			
Splash head, vertical pear shape	8851	163			
Splash head slopping pear shape	8852	164			
Steam distillation heads	8853	164			
Adapter straight cone with stopcock	8854	164			
Adapter straight socket with stopcock	8855	165			
Adapter bend cone with stopcock	8856	165			
Adapter bend socket with stopcock	8857	165			
Thermometer Pocket Long Type	8861	166			
Thermometer Pocket Short Type	8862	166			
B					
BEAKERS					
Beaker, Low form with spout	1000	101			
Beaker, Tall form without spout	1040	101			
Beaker, Tall form with spout	1060	102			
Beaker, Phillips (Conical) with spout	1080	102			
BOTTLES					
Aspirator Bottles with GL 45 Cap and Tubulation	1220	85			
Aspirator Bottles with GL 45 cap and socket	1240	85			
Aspirator Bottles with GL 45 cap and I/C stopcock	1245	86			
B.O.D. Bottles	1250	86			
Roux Bottles	1290	181			
Bottles, Reagent, narrow mouth, with I/C stopper	1500	87			
Bottles, Reagent, narrow mouth, with screw cap	1501	88			
Screw caps with pouring rings	1503	89			
High temperature resistant screw caps	1505	90			
Bottles, Reagent, wide mouth, Square	1506	90			
Bottles, Reagent, narrow mouth, with I/C stopper, Amber	1509	87			
Bottles, Reagent, narrow mouth, with screw cap, Amber	1519	89			
Bottles, tooled neck, Solution bottle	1585	90			
Bottles, tooled neck, Solution bottle, Amber	1589	91			
Bottle, relative density, with capillary, With Certificate	1624	91			
Bottle, relative density, with capillary	1625	91			
Bottle, Pyknometer, with thermometer and capillary side tube	1627	92			
Bottles, weighing, with interchangeable lids	1630	92			
Bottles, weighing, with interchangeable Amber	1631	92			
Bottles, dropping with dropper and rubber teat	1640	93			
Bottles dropping with pipette and rubber teat, Amber	1650	93			
Bottles, wash, set with interchangeable stopper	1660	93			
Bottles, stopper for wash bottles cat no. 1660	1661	94			
Bottles, flasks for wash bottles cat no. 1660	1662	94			
Bottles, plastic clamp for joint fittings	1665	96			
Bottles, wash, LDPE plastic bottles	166P	94			
Bottles, for gas washing	1760	95			
Bottles, for gas washing bottle, cat no. 1760	1762	95			
Stopper for gas washing bottle, cat no. 1760	1761	95			
Gas sampling tubes	1764	96			
Impinger	1765	96			
BURETTES					
Burettes with Boroflo stopcock, Class A	2121	58			
Burettes with Boroflo stopcock, Class B	2122	58			
Burettes With Glass stopcock, Class A	2123	60			
Burettes With Glass stopcock, Class B	2124	60			
Burettes With PTFE stopcock, Class A	2129	61			
Burettes With PTFE stopcock, Class B	2130	61			
Burettes with Boroflo stopcock, Class A, Amber	2131	59			
Burettes with Boroflo stopcock, Class B, Amber	2132	59			
Autoburettes with Glass stopcock, Class A	2149	62			
Autoburettes with Glass stopcock, Class A, Amber	2149A	63			
Autoburettes with Glass stopcock, Class B	2150	62			
Autoburettes with Glass stopcock, Class B, Amber	2150A	63			
Autoburettes with PTFE stopcock, Class A	2153	64			
Autoburettes with PTFE stopcock, Class A, Amber	2153A	65			

	Cat No.	Pg. No.		Cat No.	Pg. No.
BURETTES			DESICCATORS		
Autoburettes with PTFE stopcock, Class B	2154	64	Desiccators with Vacuum, Stopcock with PTFE Spindle, and Porcelain Plate	3083	111
Autoburettes with PTFE stopcock, Class B, Amber	2154A	65	Desiccators with Cover and Porcelain Plate, Plastic Knob, Amber	3084	110
Autoburettes with Boroflo stopcock, Class A	2155	66	Desiccators with Vacuum stopcock with PTFE spindle and Porcelain plate, Amber	3085	111
Autoburettes with Boroflo stopcock, Class A, Amber	2155A	67			
Autoburettes with Boroflo stopcock, Class B	2156	66	DISHES		
Autoburettes with Boroflo stopcock, Class B, Amber	2156A	67	Dishes, Crystallizing	3140	113
			Dishes, Culture, Petri	3160	182
			Dishes, Culture Petri, Borosil S-Line	3165	182
			Trays, Drying Heavy Wall	3170	113
			Dishes, Evaporating, Flat Bottom, With Pour Out	3180	113
C			DISTILLING APPARATUS		
CONES			Graham Condenser, I/C Joints	3340	115
Cones, Imhoff, Sediment, Sharp Tip	2160	105	Graham Condenser, I/C Joints and Stopper	3360	115
Cones, Imhoff, Sediment, Blunt Tip	2180	105	Friedrichs Condenser I/C joint and stopper	3380	115
Cones, Plain Shank, Single	6560	155	Friedrichs Condenser, Compact, I/C joint and stopper	3440	116
Cones, Plain Shank, Double	6561	155	Essential Oil Determination Apparatus (Clevenger Apparatus), as per IS 1797	3450	116
			Essential Oil Determination Apparatus (Clevenger Apparatus)	3451	117
CONDENSERS			Alcohol Distillation Unit	3452	117
Condensers, Liebig, with sealed Inner Tube	2340	107	E		
Condensers, Liebig, Drip Tip	2400	107	EXTRACTORS		
Condensers, Allihn, Drip Tip	2480	107	Soxhlet for extraction with I/C joint	3740	128
Condensers, Graham, Coiled Drip Tip	2560	108	Condensers, Allihn, for soxhlet extraction apparatus	3741	128
Condensers, Friedrichs, Drip Tip	2640	108	Soxhlet extraction apparatus set	3840	129
Condensers, Double surface	2641	108	F		
CHROMATOGRAPHY COLUMNS			FLASKS		
Chromatography Column, Plain With Glass Stopcock	6100	109	Flask, Flat bottom, narrow mouth	4060	131
Chromatography Column, Plain With Sintered Disc and Glass Stopcock	6101	109	Flask, Flat bottom, narrow mouth, short neck with I/C joint	4100	131
CYLINDERS			Flask, Round bottom, narrow mouth	4260	132
Nessler Cylinders	2975	54	Flask, Round bottom, narrow mouth short neck with I/C joint	4380	133
Cylinders Class A, Hexagonal Base, with I/C Stopper	2981	50	Flask, Round bottom, 2 necks, angular	4381	134
Cylinders Class B, Hexagonal Base, with I/C Stopper	2982	51	Flask, Round bottom, 2 necks, parallel	4382	135
Cylinders USP, Class A, Hexagonal Base, with I/C Stopper	2983	50	Flask, Round bottom, 3 necks, angular	4383	136
Cylinders Class A, Hexagonal base, Pour out	3021	51	Flask, Round bottom, 3 necks, parallel	4384	137
Cylinders Class B, Hexagonal base, Pour out	3022	52	Flask, Round bottom, 4 necks, angular	4385	138
Cylinders ASTM Class A, Hexagonal base, Pour out	3026	52	Flask, Round bottom, 4 necks, parallel	4386	139
Cylinders ASTM Class B, Hexagonal base, Pour out	3027	53	Flask, Culture, Haffkine	4422	181
Cylinders, Tapped Density Cylinder As Per USP, Ch. 616, set of two	3032	53	Flask, Distilling, With Side Arm	4620	142
Cylinders, Tapped Density Cylinder As Per USP, Ch. 616, 100ml	3033	53	Flask, Distilling, With Side Arm, with I/C joint	4621	143
Cylinders, Tapped Density Cylinder As Per USP, Ch. 616, 250ml	3034	53	Flask Kjeldahl, Round bottom	5420	143
Cylinders, Rain Measure	3070	54	Flask Kjeldahl, Round bottom, with I/C joint	5430	143
D			Flask, Conical Erlenmeyer, Narrow mouth with Rim	4980	144, 185
DESICCATORS					
Desiccators with Cover and Porcelain Plate, Plastic Knob	3082	110			

	Cat No.	Pg. No.
FLASKS		
Flask, Conical Erlenmeyer, Long Neck without Rim	4981	147, 186
Flask, Conical Erlenmeyer, without Rim	4982	147
Flask, Conical Erlenmeyer, Narrow mouth with Rim, Amber	4989	144
Flask, Conical Erlenmeyer, Narrow mouth with I/C joint	5000	145
Flask, Conical Erlenmeyer, Narrow mouth with I/C joint and stopper	5020	145
Flask, Conical Erlenmeyer, Narrow mouth with I/C joint and stopper, Amber	5019	146
Flask, Conical Erlenmeyer, with screw cap	5021	146, 186
Flask, Conical Erlenmeyer, with screw cap, Baffled bottom	5025	147, 187
Flask, Conical Erlenmeyer, Wide mouth	5100	148
Filter Flask with glass tubulation	5340	148
Iodine flask	5400	149
Tilt measure	5015	149
Flask Pear Shape with I/C joint	4315	140
Flask Rotary Evaporator with I/C joint	4320	140
Flask Reaction vessel	4330	140
Lid for Reaction vessel flask	4331	141
Dissolution E- Flask, USP, Clear	4265	80
Dissolution E- Flask, USP, Amber	4267	80
Dissolution L- Flask, USP, Clear	4266	80
Dissolution L- Flask, USP, Amber	4268	81
Dissolution D- Flask	4270	81

FILTRATION PRODUCTS

Glass Filtration Assembly, 47mm	5350	192
Glass Filtration Assembly, 90mm	5350	192
Glass Filtration Assembly, With silicone stopper, 47mm	5360	193
Glass Filtration Assembly, With silicone stopper, 25mm	5370	194
Glass Filtration Assembly with bottle, 47mm	5380	195
Glass Filtration Assembly with bottle, 90mm	5380	195
Filter membrane, Cellulose Nitrate	5147	196
Filter membrane, Gridded Cellulose Nitrate	5247	196
Filter membrane, Nylon-66	5347	196

FUNNELS

Filter Funnel, Glass, Short Stem	6140	151
Funnel test tube	6150	151
Powder Funnel	6220	151
Powder Funnel, Stem, with cone	6230	151
Separating, Globe Shape, with Stopcock and I/C Stopper	6340	152
Separating, Pear Shape, with Stopcock and I/C Stopper	6400	152
Separating, Pear Shape, with Boroflo Stopcock and I/C Stopper	6402	152
Separating, Pear Shape, with PTFE Stopcock and I/C Stopper	6403	153
Pressure equalising cylindrical with PTFE stopcock	6405	153
Dropping funnel	6408	153

K

KETTLES

Reaction Kettle Assembly	6947	141
Bottoms, only for Kettles Cat. No. 6947	6948	141
Covers, only for Kettles Cat. No. 6947	6949	142

L

LAB ACCESSORIES

Tongs for Beakers & Flasks	201
Tongs for Crucible	201
Clamps	201
Clamps with Bosshead	202
Universal Clamps	202
Burette Clamps	202
Bossheads	203
Retort Ring	203
Retort Base	203
Rod for Retort Base	203
Test Tube Stand	204
Test Tube Holder	204
Burners	204
Plastic clamps for joint fittings	96, 204
Spatulas	205
Forceps Pointed	206
Forceps PTFE Pointed	206
Forceps Blunt Dissecting	206
Forceps PTFE Blunt	206
Wire Gauge	206
Triangular Tripod	206

LABQUEST

LABORATORY EQUIPMENTS

Kjeldahl Digestion Unit	226-227
Cooling stations	228
Fume Scrubber	229
Kjeldahl distillation	230-231
Classical Kjeldahl distillation unit	232
COD digestion unit	125, 233
Thermoreactor	234
Alcohol distillation	235
Fat Determination Apparatus : Soxhlet Extraction	236, 126
Water Distillation Units	238-244
WaterBaths	245-249
Heating Mantles	250-252
Hot Plate Magnetic Stirrers	253-255
Multi Position Stirrers	256
Motorless Magnetic Stirrers	257
Magnetic Stirrers	258
Mid Stirrers	258
Max Stirrers	259
Hot Plate	259

	Cat No.	Pg. No.		Cat No.	Pg. No.
LABORATORY EQUIPMENTS			PIPETTES		
Dry Bath		260	Volumetric Pipette, Class A, ASTM	7101	40
Labware Dryer		261	Volumetric Pipette, Class A, ASTM, Amber	7106	41
Vortex Mixer		262	Volumetric Pipette, Class B	7102	41
Multi tube Vortexer		263	Volumetric Pipette, Class B, ASTM	7103	42
Micro Centrifuge		264	Mohr Piepttes, Class A	7059	42
Clinical Centrifuge		265	Mohr Piepttes, Class B	7060	43
Shakers	266-267		Mohr Piepttes, Class B, White Marking	7062	43
Chiller		268	Serological Pipettes, Class A	7079	44
Vaccum Pump		269	Serological Pipettes, Class B	7080	44
Tube Roller		270	Serological Pipettes, Class B, White Marking	7082	45
Tube Disc Rotator		270	Serological Pipettes, Class A, USP	7081	45
Micropipettes	271-275				
Fast Pipette		275			
Bottle Top dispenser		276			
Digital Burette		277			
Premium Micro Pipette Tips	278-280				
Service/ Application support		281			
M			Q		
MANSINGH SURVISMETER			QUARTZWARE		
	3453	178	Quartz Beakers, low form with spout	1002	209
MICROSCOPE SLIDES & COVERS GLASS			Quartz Muffle trays	3175	209
Microscope Slides	9100	189	Quartz Dishes / Basins round with spout	3185	209
Cover Glass	9115	189	Quartz Comustion Boat with handle	3186	210
MORTAR AND PESTLE			Quartz Crucibles without lid	3190	210
	7210	170	Quartz Lids for crucibles	3191	210
MUSEUM JARS			Quartz Volatile matter crucibles	3195, 3196, 3197	211
	6910	171	Quartz Silica traingles on Nichrome	3198	211
N			Quartz Conical flasks	4984	211
NABL CERTIFIED GLASSWARE			Quartz Volumetric Flasks	5644	212
Burettes with Boroflo stopcock, Class A, NABL Certified	2000	72	Quartz Circular Capsule	8600	212
Burettes with Boroflo stopcock, Class A, Amber, NABL Certified	2001	73	QUARTZWARE		
Burettes With Glass stopcock, Class A, NABL Certified	2002	73	Quartz Reagent Bottle, with hollow stopper	1511	212
Cylinders Class A, Hexagonal base, Pour out, NABL Certified	2010	72	Quartz Measuring cylinder w/spout class B,	3028	213
Volumetric Flask, Class A, NABL Certified	2020	70	Quartz Funnel, 75mm	6141	213
Volumetric Flask, Class A, Amber, NABL Certified	2021	70	Quartz Pipette measuring Mohr type,	7064	213
Pipette, Mohr, Class A, NABL Certified	2030	71	Quartz Pipette, Transfer, Volumetric, Class B	7104	213
Pipette, volumetric, Class A, NABL Certified	2040	71	S		
P			STOPPERS		
PIPETTES			Stoppers, Glass, Penny head, Clear	8100	36, 167
Artificial Insemination Pipette	7040	46	Stoppers, Glass, Penny head, Amber	8400	36, 167
Drum Sampling	7041	46	SINTERED WARE		
Bacteriological/Milk Pipette	7056	47	Buchner Funnel With Sintered Disc	36060	216
Gerber, Milk Pipettes	7057	47	Gooch Crucible Low Form, With Sintered Disc	32060	217
Gerber, Milk Pipettes With Certificate	7058	47	Tube for Gooch Crucible	32061	217
Volumetric Pipette, Class A	7100	40	SOCKETS		
			Sockets, Plain shank, Single	6580	155
			Sockets, Plain shank, Double	6581	155
			STIRRER ROD		
			Stirrer Rod, Glass	9850	168
			Stirrer Rod, Glass, With PTFE Blade	9860	168
			SPREADER		
				9865	182
			SAMPLING AND STORAGE VIALS		
				9913	37, 185

	Cat No.	Pg. No.		Cat No.	Pg. No.
T					
TUBES					
Blood Sugar, Folin- Wu, Tube	7840	177	Volumetric Flask, USP, Class A, Wide mouth, Clear	5647D	31
COD Digestion Tube	9835	177	Volumetric Flask, USP, Class A, Wide mouth, Amber	5657D	31
Tube Centrifuge, Plain	8060	175	Volumetric Flask, ASTM, Narrow mouth, Clear	5645	32
Tube Centrifuge, Graduated	8080	175	Volumetric Flask, ASTM, Narrow mouth, Amber	5655	32
Tube Centrifuge, Graduated with I/C Stopper	8084	175	Volumetric Flask, ASTM, Wide mouth, Clear	5647	33
Tube Centrifuge, Graduated, PP Screw Cap	8090	176	Volumetric Flask, ASTM, Wide mouth, Amber	5657	33
Tube Centrifuge, Heavy Duty, with Spout, Plain, Short conical bottom	8320	176	Volumetric Flask, Class B, Narrow mouth, Clear	5641	34
Tube Centrifuge, Heavy Duty, with Spout, Graduated, Short conical bottom	8340	176	Volumetric Flask, Class B, Narrow mouth, Amber	5649	34
			Volumetric Flask, Sugar Estimation	5650	35
TUBES					
Tube, Culture, Round Bottom, Clear, with PP Cap	9900	183	VIALS & CLOSURES		
Tube, Culture, Round Bottom, Amber, with PP Cap	9901	183	Sample Vials & Closures		
Tube, Culture, Flat Bottom, Clear, with PP Cap	9910	184	2ml Hplc Sample Vials		
Tube, Culture, Flat Bottom, Amber, with PP Cap	9911	184	2ml Glass Vials Only		220
Tube for Culture collection	9801	183	2ml Closures Only		220
			2ml Vial with Closures in a ready to use kit		221
TEST TUBES					
Test Tube, With Rim	9800	172	Headspace Vials & Closures		
Test Tube, Without Rim	9820	172	20ml Vial and Cap ready to use kits		222
Test Tube, Graduated, With I/C Stopper	9830	173	20ml Vial Only		222
Test Tube, Graduated, With I/C Stopper, Amber	9831	173	Closures		222
Test Tube, Plain, With I/C Stopper	9829	173	Pre-Assembled EPA/TOC Vial & Cap Kits		222
Test Tube, Flat bottom, Without Rim	9821	174			
Test Tube, Flat bottom, With Rim	9822	174			
V					
VISCOMETER					
Viscometer college pattern	3500	179	W		
VOLUMETRIC FLASKS					
Volumetric Flask, Class A, Narrow mouth, Clear	5640	28	WATER DISTILLATION UNITS		
Volumetric Flask, Class A, Narrow mouth, Amber	5648	28	Single Distillation Unit Horizontal Type	3361	119
Volumetric Flask, Class A, Wide mouth, Clear	5643	29	All Glass Distillation Unit, with Borosilicate Boiler	3362	
Volumetric Flask, Class A, Wide mouth, Amber	5653	29	Mono Quartz Distillation Unit Vertical Model	3363	120
Volumetric Flask, USP, Class A, Narrow mouth, Clear	5645D	30	Mono Quartz Distillation Unit	3364	121
Volumetric Flask, USP, Class A, Narrow mouth, Amber	5655D	30	All Quartz Double Distillation Unit	3365	122
			Cabinet Still Unit	3370	123
			ECO MS, All glass single distillation system		124
			Silicone tubing for distillation unit & laboratory application	3369	124
			WEIGHING SCOOP		
				7200	37,169
			WATCH GLASS		
				9986	169
			TECHNICAL INFORMATION		
					282-288

NOTES

A series of horizontal dotted lines for writing notes, organized into three columns.

We, **BOROSIL LIMITED** (which was a wholly owned subsidiary of **Borosil Glass Works Limited** and formerly known as Hopewell Tableware Limited), a company registered under the Companies Act, 1956 and having its registered office at 1101, Crescenzo House, 44, Dr. R.G. Thadani Marg, Worli, Mumbai - 400018. are the owners and proprietor's of the Trademark **BOROSIL®**, which is a registered mark. Pursuant to NCLT Mumbai Bench order dated 15 Jan 2020, sanctioning a Composite Scheme of Amalgamation and Arrangement, the trademark **BOROSIL** which was earlier owned by BGWL has been vested in **BOROSIL LIMITED**.

The said, trademark **BOROSIL®** has been used in the market, to sell and export a wide variety of glassware products since more than 5(five) decades throughout India as well as several countries across the globe.

The Trademark **BOROSIL®** has acquired a very high reputation and goodwill by virtue of long, extensive and continuous use. The said trademark is associated and identified exclusively with the goods manufactured, marketed and sold by **BOROSIL LIMITED** (which was a wholly owned subsidiary of **Borosil Glass Works Limited** and formerly known as Hopewell Tableware Limited).

It has, from time to time come to our notice that some persons occasionally try to sell spurious goods by copying the **BOROSIL®** trademark and/or 'Borosil Logo' 

The trade and public are cautioned that only products manufactured, marketed and sold by erstwhile **Borosil Glass Works Limited** and **BOROSIL LIMITED** are permitted to carry the trademark **BOROSIL®** or 'Borosil Logo' 

Those who are deceiving the public by copying the Trademark **BOROSIL®** or 'Borosil Logo'  or using it wrongly on products not made, marketed and /or sold by **Borosil Limited** (which was a wholly owned subsidiary of **Borosil Glass Works Limited** and formerly known as Hopewell Tableware Limited), will be prosecuted and **Borosil Limited** will adopt all legal recourse available to it, which may be Civil or Criminal in nature and may include police raids, to prevent such unauthorized use without giving further notice.

The Trade and Public are cautioned that they should always request for a bill on purchase of their products, as spurious goods are harmful and have dangerous and adverse effects to the life of the user as well as the nation.

We request you to bring to our attention any instances of such nefarious activities, which you may come across, we shall maintain the secrecy of you identify.

Correspondence in this connection may please be made at registered office address of the Company.

visit www.loveforscience.in

PERIODIC TABLE OF THE ELEMENTS

BY **BOROSIL**
Love For Science

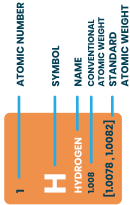

1 H HYDROGEN 1.008 [1.00784, 1.0082]	2 He HELIUM 4.0026	3 Li LITHIUM 6.94 [6.938, 6.997]	4 Be BERYLLIUM 9.0122	5 B BORON 10.81 [10.806, 10.822]	6 C CARBON 12.01 [12.009, 12.012]	7 N NITROGEN 14.007 [14.006, 14.008]	8 O OXYGEN 15.999 [15.999, 16.000]	9 F FLUORINE 18.998	10 Ne NEON 20.180	11 Na SODIUM 22.990	12 Mg MAGNESIUM 24.305 [24.304, 24.307]	13 Al ALUMINIUM 26.982	14 Si SILICON 28.086 [28.084, 28.088]	15 P PHOSPHORUS 30.974	16 S SULFUR 32.06 [32.059, 32.078]	17 Cl CHLORINE 35.45 [35.446, 35.457]	18 Ar ARGON 39.95 [39.792, 39.963]	19 K POTASSIUM 39.098	20 Ca CALCIUM 40.078 (4)	21 Sc SCANDIUM 44.956	22 Ti TITANIUM 47.887	23 V VANADIUM 50.942	24 Cr CHROMIUM 51.996	25 Mn MANGANESE 54.938	26 Fe IRON 55.854 (2)	27 Co COBALT 58.933	28 Ni NICKEL 58.693	29 Cu COPPER 63.546 (2)	30 Zn ZINC 65.38 (2)	31 Ga GALLIUM 69.723	32 Ge GERMANIUM 72.630 (6)	33 As ARSENIC 74.922	34 Se SELENIUM 78.971 (6)	35 Br BROMINE 79.904 [79.801, 79.907]	36 Kr KRYPTON 83.798 (2)	37 Rb RUBIDIUM 85.468	38 Sr STRONTIUM 87.62	39 Y YTRIUM 88.906	40 Zr ZIRCONIUM 91.224 (2)	41 Nb NIOBIUM 92.906	42 Mo MOLYBDENUM 95.95	43 Tc TECHNETIUM 98.906 (2)	44 Ru RUTHENIUM 101.07 (2)	45 Rh RHODIUM 102.91	46 Pd PALLADIUM 106.42	47 Ag SILVER 107.87	48 Cd CADMIUM 112.41	49 In INDIUM 114.82	50 Sn TIN 118.71	51 Sb ANTIMONY 121.76	52 Te TELLURIUM 127.60 (3)	53 I IODINE 126.90	54 Xe XENON 131.29	55 Cs CAESIUM 132.91	56 Ba BARIUM 137.33	57 Fr FRANCIUM	58 Ra RADIUM	59 La LANTHANUM 138.91	60 Ce CERIUM 140.12	61 Pr PRASEODYMIUM 140.91	62 Nd NEODYMIUM 144.24	63 Pm PROMETHIUM	64 Gd GADOLINIUM 157.25 (3)	65 Tb TERBIUM 158.93	66 Dy DYSPROSIUM 162.50	67 Ho HOLIUM 164.93	68 Er ERBIUM 167.26 (2)	69 Tm THULIUM 168.93	70 Yb Ytterbium 173.05	71 Lu LUTETIUM 174.97	72 Hf HAFNIUM 178.49 (2)	73 Ta TANTALUM 180.95	74 W TUNGSTEN 183.84	75 Re RHENIUM 186.21	76 Os OSMIUM 190.23 (3)	77 Ir IRIDIUM 192.22	78 Pt PLATINUM 195.08	79 Au GOLD 196.97	80 Hg MERCURY 200.59	81 Tl THALLIUM 204.38 [204.38, 204.39]	82 Pb LEAD 207.2	83 Bi BISMUTH 208.98	84 Po POLONIUM	85 At ASTATINE	86 Rn RADON	87 Fr FRANCIUM	88 Ra RADIUM	89-103 ACTINOIDS	89 Ac ACTINIUM 227.04	90 Th THORIUM 232.04	91 Pa PROTACTINIUM 232.04	92 U URANIUM 238.03	93 Np NEPTUNIUM	94 Pu PLUTONIUM	95 Am AMERICIUM	96 Cm CURIUM	97 Bk BERKELIUM	98 Cf CALIFORNIUM	99 Es EINSTEINIUM	100 Fm FERMIUM	101 Md MENDELEVIUM	102 No NOBELIUM	103 Lr LAWRENCIUM
---	------------------------------------	---	---------------------------------------	---	--	---	---	-------------------------------------	-----------------------------------	-------------------------------------	--	--	--	--	---	--	---	---------------------------------------	--	---------------------------------------	---------------------------------------	--------------------------------------	---------------------------------------	--	---------------------------------------	-------------------------------------	-------------------------------------	---	--------------------------------------	--------------------------------------	--	--------------------------------------	---	--	--	---------------------------------------	---------------------------------------	------------------------------------	--	--------------------------------------	--	---	--	--------------------------------------	--	-------------------------------------	--------------------------------------	-------------------------------------	----------------------------------	---------------------------------------	--	------------------------------------	------------------------------------	--------------------------------------	-------------------------------------	-----------------------------	---------------------------	--	-------------------------------------	---	--	-------------------------------	---	--------------------------------------	---	-------------------------------------	---	--------------------------------------	--	---------------------------------------	--	---------------------------------------	--------------------------------------	--------------------------------------	---	--------------------------------------	---------------------------------------	-----------------------------------	--------------------------------------	---	----------------------------------	--------------------------------------	-----------------------------	-----------------------------	--------------------------	-----------------------------	---------------------------	---------------------	---------------------------------------	--------------------------------------	---	-------------------------------------	------------------------------	------------------------------	------------------------------	---------------------------	------------------------------	--------------------------------	--------------------------------	-----------------------------	---------------------------------	------------------------------	--------------------------------

- ALKALI METALS
- ALKALINE EARTH METALS
- TRANSITION METALS
- BASIC METALS
- SEMI-METALS
- NONMETALS
- NOBLE GASES
- LANTHANIDES
- ACTINOIDS

Did you know?
Dmitry Mendeleev discovered the periodic system 150 years ago. To commemorate this, 2018 has been proclaimed the International Year of the Periodic Table of Chemical Elements.

CIN : L36100MH2010PLC292722

Registered & Corporate Office :

1101, Crescenzo, G-Block, Opp. MCA Club,
Bandra Kurla Complex, Bandra (East),
Mumbai - 400 051. Maharashtra, India.
T +91 22 6740 6300 F +91 22 6740 6514
E borosil@borosil.com W www.borosil.com

MUMBAI

B-306, Kanakia Zillion,
L.B.S. Marg, Kurla (West)
Mumbai - 400 070

Tel : 022 6740 6400
Fax : 022 6740 6444
Email : mumbaisales@borosil.com

DELHI

1213 Vijaya Building
17 Barakhamba Road
New Delhi 110001

Tel : 011 41505893
Email : delhi@borosil.com

CHENNAI

New No. 20 (Old No. 9)
1st Floor, Bragadammal Road,
Nungambakkam,
Chennai - 600 034.

Tel : 044 2822 6012 / 13
Fax : 044 2822 6014
Email : chennai@borosil.com

KOLKATA

Dabriwala House, 4th Floor,
10 C Middleton Row,
Kolkata - 700 071.

Tel : 033 2229 9166
Fax : 033 2226 2045
Email : calcutta@borosil.com